

UNCLASSIFIED

AD NUMBER	
AD387145	
CLASSIFICATION CHANGES	
TO:	unclassified
FROM:	confidential
LIMITATION CHANGES	
TO:	Approved for public release, distribution unlimited
FROM:	Distribution authorized to U.S. Gov't. agencies and their contractors; Administrative/Operational Use; 18 JAN 1968. Other requests shall be referred to Assistant Chief of Staff for Force Development [Army], Washington, DC.
AUTHORITY	
31 Jan 1980, DoDD 5200.10; OAG ltr, 29 Apr 1980	

THIS PAGE IS UNCLASSIFIED

THIS REPORT HAS BEEN DELIMITED
AND CLEARED FOR PUBLIC RELEASE
UNDER DOD DIRECTIVE 5200.20 AND
NO RESTRICTIONS ARE IMPOSED UPON
ITS USE AND DISCLOSURE.

DISTRIBUTION STATEMENT A

APPROVED FOR PUBLIC RELEASE;
DISTRIBUTION UNLIMITED.

SECURITY

MARKING

The classified or limited status of this report applies to each page, unless otherwise marked.

Separate page printouts MUST be marked accordingly.

THIS DOCUMENT CONTAINS INFORMATION AFFECTING THE NATIONAL DEFENSE OF THE UNITED STATES WITHIN THE MEANING OF THE ESPIONAGE LAWS, TITLE 18, U.S.C., SECTIONS 793 AND 794. THE TRANSMISSION OR THE REVELATION OF ITS CONTENTS IN ANY MANNER TO AN UNAUTHORIZED PERSON IS PROHIBITED BY LAW.

NOTICE: When government or other drawings, specifications or other data are used for any purpose other than in connection with a definitely related government procurement operation, the U. S. Government thereby incurs no responsibility, nor any obligation whatsoever; and the fact that the Government may have formulated, furnished, or in any way supplied the said drawings, specifications, or other data is not to be regarded by implication or otherwise as in any manner licensing the holder or any other person or corporation, or conveying any rights or permission to manufacture, use or sell any patented invention that may in any way be related thereto.



CONFIDENTIAL

**DEPARTMENT OF THE ARMY
OFFICE OF THE ADJUTANT GENERAL
WASHINGTON, D.C. 20310**

19

IN REPLY REFER TO

AGAM-P (M) (15 Jan 68) FOR OT RD-670742

18 January 1968

SUBJECT: Operational Report - Lessons Learned, Headquarters,
1st Infantry Division, Period Ending 31 July 1967

TO: SEE DISTRIBUTION

AD 387145

1. Subject report is forwarded for review and evaluation by USACDC in accordance with paragraph 6f, AR 1-19 and by USCONARC in accordance with paragraph 6c and d, AR 1-19. Evaluations and corrective actions should be reported to ACSFOR OT within 90 days of receipt of covering letter.

2. Information contained in this report is provided to insure appropriate benefits in the future from Lessons Learned during current operations, and may be adapted for use in developing training material.

BY ORDER OF THE SECRETARY OF THE ARMY:

KENNETH G. WICKHAM
Major General, USA
The Adjutant General

1 Incl
as

DISTRIBUTION:

- Commanding Generals
 - US Continental Army Command
 - US Army Combat Developments Command
- Commandants
 - US Army Command and General Staff College
 - US Army War College
 - US Army Air Defense School
 - US Army Armor School
 - US Army Artillery and Missile School
 - US Army Aviation School
 - US Army Chemical School
 - US Army Civil Affairs School
 - US Army Engineer School
 - US Army Infantry School
 - US Army Intelligence School
 - US Army Adjutant General School
 - US Army Missile and Munitions School
 - US Army Southeastern Signal School

REGRADED UNCLASSIFIED
WHEN SEPARATED FROM
CLASSIFIED INCLOSURES

CONFIDENTIAL

CONFIDENTIAL

DISTRIBUTION (Cont'd)

US Army Medical Field Service School
US Army Military Police School
US Army Ordnance School
US Army Quartermaster School
US Army Security Agency School
US Army Signal School
US Army Special Warfare School
US Army Transportation School

Copies Furnished:

Office, Chief of Staff, US Army
Deputy Chiefs of Staff
Chief of Research and Development
Assistant Chiefs of Staff
Chief of Engineers
The Surgeon General
The Provost Marshal General
Research Analysis Corporation (Library)
Dr. Martin J. Bailey, OSD (SA)
National Aeronautics and Space Administration, Office of Defense Affairs
Joint Action Control Office
Director, Weapons System Evaluation Group
Defense Documentation Center
Commanding Generals
US Army Weapons Command
1st Infantry Division

CONFIDENTIAL



CONFIDENTIAL

DEPARTMENT OF THE ARMY
HEADQUARTERS 1ST INFANTRY DIVISION
APO San Francisco 96345

AVDB-T

25 August 1967

SUBJECT: Operational Report-Lessons Learned for the Period
1 May - 31 July 1967, (RCS CSFOR-65)

THRU: Commanding General
II Field Force, Vietnam
ATTN: G-3 Analysis
APO 96266

TO: Assistant Chief of Staff for Force Development
Department of the Army
Washington, D. C. 20310

The inclosed Operational Report-Lessons Learned is forwarded in compliance with AR 1-19 and USARV Regulation 1-19.

FOR THE COMMANDER:

1 Incl
as

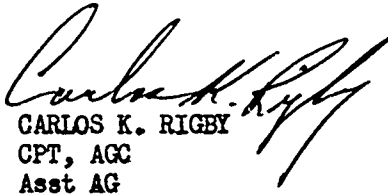
CARLOS K. RIGBY
CPT, AGC
Asst AG

DOWNGRADED AT 3 YEAR INTERVALS
DECLASSIFIED AFTER 12 YEARS
DOD DIR 5200.10

FOR OT RD File
670742

CONFIDENTIAL

60

I. Significant Organization and Unit Activities	Page
A. Introduction -----	1
B. Organization -----	1
C. Intelligence -----	2
D. Combat Operations -----	6
E. Training -----	12
F. Psychological Operations and Civic Action, Revolutionary Development Support -----	13
G. Personnel and Administration -----	16
H. Logistics (See Inclosure 6)	
II. Commander's Observations and Recommendations	
A. Observations (Lessons Learned) -----	18
B. Recommendations -----	28

III. Inclosures

- Withdrawn, Hqs, DA
 - ~~1. Roster of Key Personnel~~
 - ~~2. Organization Chart~~
- Withdrawn, illegible
 - ~~3. 1st Brigade - Operational Report-Lessons Learned~~
 - 4. 2d Brigade - Operational Report-Lessons Learned
 - 5. 3d Brigade - Operational Report-Lessons Learned
- Withdrawn, Hqs, DA
 - ~~6. Support Command - Operational Report-Lessons Learned~~
 - ~~7. 121st Signal Battalion - Operational Report-Lessons Learned~~
 - 8. 1st Engineer Battalion - Operational Report-Lessons Learned
- Withdrawn, Hqs, DA
 - ~~9. 1st Aviation Battalion - Operational Report-Lessons Learned~~
 - ~~10. 1st MP Company - Operational Report-Lessons Learned~~
 - 11. Division Chemical Section - Operational Report-Lessons Learned
 - 12. Division Artillery - Operational Report-Lessons Learned
 - 13. Ambush, dated 5 August 1967
- Withdrawn, Hqs, DA
 - ~~14. Commanders Notes # 5,6,7~~
 - 15. Battle Narrative AP TAU O
 - 16. Battle Narrative AP BAW BANG
 - 17. Battle Narratives PUEK KLOK I & II

FOR OT RO
670742

18. Battle Narratives XOM BO I & II
19. Battle Narrative, "C" Company, 1-2 Infantry at XT675868 on
21 March 1967
20. Battle Narrative, 11 July 1967 VC Raid on QUAN LOI
21. 1st Combat Aviation Battalion - After Action Report Operation
10-67
22. Operation PAUL BUNYAN - 1st Engineer Battalion
23. Operation BLUEFIELD - After Action Reports
24. 1st Division Publication - Fundamentals of Infantry Tactics

4

CONFIDENTIAL

DEPARTMENT OF THE ARMY
HEADQUARTERS 1ST INFANTRY DIVISION
APO San Francisco 96345
Unit Identification Code: AB

AVDB-T

SUBJECT: Operational Report-Lessons Learned (RCS CSFOR-65) 1 May 1967 -
31 July 1967

I. Significant Organization and Activities

A. Introduction

1. This Operational Report-Lessons Learned covers the reporting period 1 May - 31 July 1967. During this period the 1st Infantry Division continued to conduct combat operations designed to locate and destroy Viet Cong (VC) and North Vietnamese Army (NVA) forces and installations in the III Corps Tactical Zone (CTZ). Operation MANHATTAN continued into this quarter with a large arms cache and substantial amounts of enemy supplies being captured or destroyed. Operation DALLAS took place in an area east of Highway 16, from the SONG BE River south toward TAN UYEN. The significant aspect of this operation was the destruction of the VINH LOI Woods. There were no major contacts with the enemy during the operation. The 1st Division then tasked the 3d Brigade to conduct Operation BLUEFIELD in the area extending from Highway 13 east to the SONG BE River and from Route 2A north to the XT57 east-west grid line. A number of small base camp complexes and one province headquarters (XT8646) were located along with the capture of moderate amounts of enemy supplies and equipment. This operation also insured the Division that there were no large enemy forces within rocket/mortar range of PHUOC VINH or LAI KHE, although the threat remained. In Operation BILLINGS the 1st Division initiated its first major offensive operation into the VC fortified jungle stronghold of War Zone D. Two major engagements with enemy forces occurred during this operation, resulting in two defeats for elements of the 271st VC Regiment.

2. The Indirect Support of the GVN Revolutionary Development Program by the 1st Infantry Division under the name Operation LAM SON 67 continued during the reporting period. The 2d Brigade, improving its operating techniques, began to conduct numerous cordon and search operations in the area. Also, work progressed on the project to clear the ONG DONG Jungle under the code name Operation PAUL BUNYAN.

3. Base camp security continued with greater emphasis being placed on improving the camps' security and fortifications. Numerous resupply convoys were conducted without a major engagement through areas that were formerly under Viet Cong control. One such convoy moved from QUAN LOI in the north to DI AN in the south. Snipers and mines continued to be a major road hazard.

B. Organization

1. The 1st Infantry Division continued to occupy four major base camps, at DI AN (XT895065), PHU LOI (XT854160), LAI KHE (XT765380), and PHUOC VINH (XT963490), and a forward base area at QUAN LOI (XT818905). The division forward command post was located at LAI KHE from 10 June 1967 to 8 July 1967 when it returned to DI AN for the remainder of the reporting period.

DOWNGRADED AT 3 YEAR INTERVAL
DECLASSIFIED AFTER 12 YEARS
DOD DIR 8200.10

CONFIDENTIAL

FOR OR RO
670742

6

CONFIDENTIAL

2. Significant changes in organization did occur during the reporting period. The division's tactical strength was augmented in May 1967 by the arrival in Vietnam of the 6th Battalion, 15th Artillery. Attached by USARPV General Order 2433 to the 1st Division Artillery, the 6-15 Artillery increased the artillery support available to the Division from four battalions organic by TO&E to a total of five artillery battalions. The 6-15th Artillery consists of three firing batteries and a HQ & HQ battery of 105mm towed Howitzers. The battalion operates from LAI KHE and consists of 34 officers, 2 warrant officers, and 546 enlisted personnel.

3. A major reorganization of the division's infantry battalions was initiated during the reporting period, in accordance with USARPAC General Order Number 30, dated 7 February 1966. With the addition of one rifle company, a battalion S-5 and a combat support company, the reorganized infantry battalion will consist of four rifle companies, a headquarters and headquarters company, and a combat support company. The reorganization gives the division nine additional line companies. By providing enough personnel to leave three companies at each brigade camp for base security, the replacement packets release three infantry battalions for combat operations.

a. Reorganization of the rifle company, the headquarters and headquarters company, and the combat support company will be according to USARPAC MTOE's 7-18L, 7-16E, and 7-176T, respectively. Modification by a 1st Division General Order will attach the reconnaissance platoon and surveillance section to headquarters and headquarters company from the combat support company. The headquarters company commander will spend the major portion of his time at the battalion forward command post during field operations and will be responsible for forward command post activities. The combat support company commander is to be responsible for command post activities and security activities at the battalion's rear base.

b. Additional personnel for the combat support company and the fourth rifle company will come from replacement packets sent from CONUS and from existing division resources. On 22 July 1967 the fourth rifle companies (about 130 personnel each) for the 1st and 2d Brigades arrived in VUNG TAU. The 3d Brigade's D Company packets arrived in VUNG TAU on 28 July. The three existing line companies of each battalion have provided a percentage of experienced personnel, not exceeding 15% of their authorized strength, in exchange for new D Company personnel. At the end of the reporting period the new rifle companies had begun a 70-day training period before they engage in regular combat operations by rotating in the field with the other companies of the battalion. The training program includes individual environmental training, unit and company training, and base camp patrolling and security.

C. Intelligence

1. Enemy Order of Battle

a. The total estimated strength of the enemy military threat in the 1st Infantry Division area of interest is 17,515 personnel. This figure represents a combat strength of 15,515 and 2,000 logistical personnel who support main force elements.

b. Reinforcements are available from outside the division's area of interest. From the west is the 101st NVA Inf Regt; from the southwest, DL4 Local Force Bn; from the south, 1st, 2d, 4th, 5th, 6th, 7th, and 8th battalions of the 165A Regiment. Of these battalions from the 165A Regt the primary interest is with 2d, 4th, and 7th battalions. From the southeast is the DONG NAI VC MF Inf Bn and the 2d and 3d battalions of the 275th VC Inf Regt; from the east is the security element of MR-1, and the 84A NVA Artillery Regiment.

2

CONFIDENTIAL

7

CONFIDENTIAL

c. The 7th NVA Division consists of 165th NVA Infantry Regiment, 141st NVA Infantry Regiment and probably acquired control of the 101st NVA Infantry Regiment in May 1967, to provide it with a full complement of subordinate tactical units. The division has been on the move with the Division Headquarters element located in TAY NINH Province (XT4280) in early May, then moving into BINH LONG Province (XU6010) in July 1967. It is believed that the 52d NVA Regiment has been deactivated to provide replacements for other main force units.

(1) The 165th NVA Infantry Regiment remained unlocated throughout the reporting period, but is believed to be in War Zone "C". The possibility also exists that the 165th NVA Inf Regt has taken over the security mission of the "Fish Hook" (XT5595) area in place of the 272d VC Regt, which departed during the last week in June and there is also some evidence of an unidentified regiment west of CHAN THANH (XT766630) which may be the 165th NVA Inf Regt.

(2) The 141st NVA Regt remained in east-central War Zone "C" until early July when it moved to the vicinity of AN LOC - QUAN LOI and is believed to still be in that general area west of the SONG BE River. Recent contacts by USSF SIGMA teams reveal the presence of main force units vicinity XT8799, which could possibly be elements of the 141st Regt. The unit is considered to be combat effective, despite losses suffered during the encounter of 11-12 July, and consequently poses a threat to friendly installations in BINH LONG Province.

(3) The 101st NVA Inf Regt has remained in the 25th Infantry Division's TAOL. However, as long as the regiment remains in the general area northwest of DAU TIENG it is possible that it could turn from its obvious targets of SUOI DA, DAU TIENG, and TAY NINH and strike unexpectedly at CIDG posts such as MINH THANH.

d. The 9th VC Division consisting of the 271st VC Infantry Regiment, 272d VC Infantry Regiment, and the 273d VC Infantry Regiment has been operating in the same general area throughout the reporting period except for the 272d VC Inf Regt which has moved from the "Fish Hook" area (XT5691) into PHUOC LONG Province (XU9510). The employment of the 273d VC Inf Regt in the DONG NAI River area was one of the first indications that this unit has been resubordinated to the 9th VC Div, probably replacing the 101st NVA Regt.

(1) The 271st VC Regt since June 1967, was believed to be offensively disposed and capable of mounting regimental size attacks. It has remained in the southern portion of PHUOC LONG Province and became heavily engaged with elements of the 1st Infantry Division on 17 June. During mid-June the 271st VC Regt suffered heavy casualties and spent the next three weeks recovering from these losses and refitting for future operations. Indications were that the 271st VC Regt coordinated with the 844 Artillery Regiment and probably provided security forces for the rocket battalion in the attack on PHUOC VINH on 27 July. The 271st is probably also responsible for the mortar rounds fired on PHUOC VINH.

(2) The 272d VC Regt remained in the "Fish Hook" area undergoing training and performing a security mission until about the first week of July. A rallier from the 272d VC Regt stated that the unit traveled well to the north around LOC NINH. It is possibly now located east of LOC NINH in western PHUOC LONG. The union of the 272d VC Regt with the remainder of the 9th VC Division would considerably enhance the latter's offensive capabilities.

CONFIDENTIAL

CONFIDENTIAL

(3) The 273d VC Regt was located in the LONG NGUYEN Secret Zone (XT6000) in early May. Documents taken from the bodies of three VC killed during the rocket and mortar attack of BIEN HOA on 12 May, gave probable identification of the 273d VC Regt and specifically the regimental mortar company. The attack of BIEN HOA was followed immediately by mortar attacks on TAN UYEN and PHUOC VINH. The three attacks were probably coordinated actions by the 9th VC Division. The employment of the 273d VC Regt in the DONG NAI River area indicates that this unit has been resubordinated to the 9th VC Division, probably replacing the 101st NVA Regt. The 273d Regt reportedly moved to the west into the "Catcher's Mitt" area in the bow of the SONG BE and DONG NAI Rivers. The "Catcher's Mitt" has long been used as a base area for the unit and was used as the springboard for the attack on BIEN HOA airbase on 12 May. Agent reports indicated that the 273d VC Regt would again attack the BIEN HOA - LONG BINH complex in the latter part of July. Scattered engagements along the DONG NAI River during late July with elements of the 1st US Infantry Division may have delayed such a plan for the present. However, the 273d could turn to other targets in the area such as TAN UYEN or PHUOC VINH or targets in the mid-LAM SON area. TAN UYEN was hit with approximately 100 81mm mortar rounds on 27 and 29 July. This could have possibly been the 273d VC Regt. It is suspected that elements of the 273d VC Regt with elements of the 84A Artillery Regt were involved in the attack on PHU LOI (XT840152) on 29 July 1967.

e. The accepted locations of confirmed enemy units within the 1st Div TAOI and along its periphery are:

<u>UNIT</u>	<u>STRENGTH</u>	<u>GBT EFFECTIVENESS</u>	<u>CURRENT PROBABLE LOCATION</u>
<u>5th VC Div</u>	4,475	Marginal	PHUOC TUY
24th NVA AABn	250	Unk	PHUOC TUY
274th VC Inf Regt	1,650	GBT EFFECTIVE	PHUOC TUY
275th VC Inf Regt	1,500	GBT EFFECTIVE	2 Bn BIEN HOA/LONG KHANH BORDER
			1st Bn PHUOC TUY
<u>7th NVA DIV</u>	6,590	GBT EFFECTIVE	TAY NINH
165th NVA Inf Regt	1,850	GBT EFFECTIVE	TAY NINH
141st NVA Inf Regt	1,650	GBT EFFECTIVE	TAY NINH or eastern BINH LONG
101st NVA Inf Regt	2,090	GBT EFFECTIVE	TAY NINH
Hq & Spt Units	1,000	Unk	BINH LONG
<u>9th VC Div</u>	6,205	GBT EFFECTIVE	PHUOC LONG
271st VC Inf Regt	1,500	GBT EFFECTIVE	PHUOC LONG
272d VC Inf Regt	1,990	GBT EFFECTIVE	PHUOC LONG
273d VC Inf Regt	1,500	GBT EFFECTIVE	LONG KHANH
Hq & Spt Units	950	Unk	PHUOC LONG
22d VC Arty Bn	Unk	Unk	War Zone "D"
24th VC AA Bn	265	Unk	War Zone "D"
<u>69th VC Artillery Cnd</u>	2,790	GBT EFFECTIVE	TAY NINH
52d VC Arty Bn	320	GBT EFFECTIVE	TAY NINH
56th VC AA Bn	450	GBT EFFECTIVE	TAY NINH
58th VC Arty Bn	420	GBT EFFECTIVE	TAY NINH
84A NVA Arty Regt	1,200	GBT EFFECTIVE	LONG KHANH
Hq & Spt Units	400	GBT EFFECTIVE	TAY NINH
46th VC Recon Bn of COSVN	400	Unk	BINH LONG
66th VC Base Security Regt	500	Unk	UNLOCATED
725th NVA Sniper Bn	570	Unk	UNLOCATED
DONG NAI VC MF Inf Bn	335	GBT EFFECTIVE	LONG KHANH
PHU LOI VC LF Inf Bn	400	GBT EFFECTIVE	BINH DUONG
1st Bn 165A Regt	Unk	Unk	UNLOCATED
3d Bn 165A Regt	330	GBT EFFECTIVE	DI AN DISTRICT

4

CONFIDENTIAL

CONFIDENTIAL

9

f. Strength and Dispositions of administrative Units

<u>UNIT</u>	<u>STRENGTH</u>	<u>CURRENT PROBABLE LOCATION</u>
76th Replacement Regt	500+	PHUOC LONG/CUANG DUC Province Border
48th Trans Bn	400	UNLOCATED in War Zone "C"
81st Rear Service Gp	500	UNLOCATED IN War Zone "D"
83d Rear Service Gp	900	BINH DUONG
85th Rear Service Gp	180	UNLOCATED IN BINH LONG Province
86th Rear Service Gp	500	Possibly in vic VJ2829

2. Enemy forces in the 1st Inf Div TACI are considered to be in an offensive posture at the close of the reporting period. The emphasis has shifted from infantry attacks by the enemy to longer range mortar and rocket attacks.

a. 122mm rockets were used during the past three months with limited success. The rockets are normally employed at ranges between 7,000 and 10,000 meters. The rocket has a minimum range of 2,000 meters and a maximum range of 11,000 meters. No launcher for the 122mm rocket has been obtained by free world forces. It is believed that the minimum elevation is 10 degrees with a maximum elevation of 42 degrees. It is necessary to employ the rocket from a launch position which has mask clearance. As a result of this method of employment, it is normally employed in small valleys or stream beds running in the general direction of the target. It appears that the VC/NVA forces desire to employ this weapon near streams and rivers on which they may use small sampans, in order to relieve the necessity of man-packing the rocket. It is normally transported in two major sections, the rocket body and the motor in one section, contained in a canvas carrying case. Two people normally carry the case. The war head, which contains 22 pounds of RDX, TNT, and aluminum powder as its explosive filler, is carried in another canvas case by one man and has a small pocket attached where the fuse remains until time to replace the rocket. The rocket launcher unit is believed to travel in approximately a battalion-size unit. It is customary to prepare individual positions prior to preparation of the launcher position. The launcher position may be prepared in a relatively few hours, judging from evidence found at one of the launcher positions. It is believed that the positions may be prepared using sticks as measurements for the launcher legs in order to have the launcher position fully prepared before assembling and replacing the launcher. It is believed the launcher weighs approximately 100-200 pounds, and breaks into loads of 40 pounds or less. Due to the security force that is employed with the launcher unit, it is believed that the launcher is far more critical in supply than the rockets. The war head has three fuse settings: super quick, short delay, and long delay. Normally the super quick setting is used when the rocket is being employed against parked aircraft in order to take advantage of maximum shrapnel effect. The war head liner has a designed fragmentation pattern. The short delay fuse is used against normal building structures for damage and infliction of personnel casualties. The long delay fuse setting is utilized against reinforced or protected or hardened targets. The super quick fuse setting detonates the round so rapidly that the crater is approximately the same size as that of an 82mm mortar crater. The short delay setting allows the war head to penetrate into soil or other similarly hard surfaces for the short distance and produce a crater approximately 4 1/2 by 9 feet in diameter. The crater is normally teardrop shaped and is elongated in the direction of the launcher. The long delay fuse setting allows the war head to penetrate approximately 10 feet, and it thereby produces an explosion completely underground or inside bunker positions. No duds have ever been known to occur on the 122mm war head. The most effective defense currently available against attack by rockets of the 122mm size is extensive surveillance and reconnaissance of all useable launch sites within a 2,000 meter to 11,000 meter radius of the suspected target. Indications are that the 122mm rocket crews can fire rockets at the rate of one each two minutes per launcher.

5

CONFIDENTIAL

CONFIDENTIAL

10

b. The Viet Cong have been reported using a new type mine. During engagements in late July, troops of the 1st Infantry Division reported seeing a mine suspended from a tree by a rope. The mine was the approximate size and shape of a basketball and was swung to a position to the rear of friendly troops and detonated. This is the first report of the use of such a "Basketball Mine" in the 1st Infantry Division area.

3. By destroying the enemy's jungle haven with bulldozers and chemical defoliation, the VC have been unable to maintain tactical integrity of the local force units. In many cases they have been forced to divide the units into small teams to operate in the local villages.

4. VC losses for the reporting period include:

- a. 655 VC KIA (BC)
- b. 12 PW's captured
- c. 723 individual weapons captured
- d. 160.3 tons of rice captured or destroyed
- e. 1,510 grenades captured or destroyed
- f. 10 tons of salt captured or destroyed
- g. 374,495 rounds of small arms ammunition captured or destroyed
- h. 476 mines captured or destroyed

D. Combat Operations

1. General: During the reporting period the 1st Infantry Division continued military operations to extend and to consolidate the government of Vietnam's control and influence in the III Corps Tactical Zone (CTZ). Six operations were conducted within and outside of the division's assigned Tactical Area of Responsibility (TAOR). These operations were HARVEST MOON and MANHATTAN, which began during the previous reporting period, DALLAS, BLUEFIELD, BILLINGS, and LAM SON 67. Increased attention was given to the overwatch of Special Forces Camps and friendly military installations within the 1st Division's Tactical Area of Interest (TAOI).

2. Operation HARVEST MOON: Operation HARVEST MOON continued from the previous reporting period. As was formerly reported the operation commenced on 5 April 1967 with the 1st Infantry Division securing the engineer construction site at BUNARD (YT270888). During the period the engineers built a Special Forces-CJDC camp and an airfield capable of landing C-130 aircraft at that location. Several VC base camps were located in the area; however, there was no contact or significant enemy activity observed in the area. On 9 May 1967 the 1st Infantry Division terminated its participation in Operation HARVEST MOON and repositioned the infantry battalion and artillery elements to QUAN LOI by fixed wing aircraft.

3. Operation MANHATTAN: Operation MANHATTAN was officially initiated in the previous reporting period on 23 April 1967 with the 11th Armored Cavalry Regiment (-) (attached to the 1st Division) and the 3d Brigade. The latter conducted air assaults into multiple landing zones (LZ) within the area of operations. The general area of operations encompassed a strip extending northwest from the "Iron Triangle" to the Michelin Plantation between the SAIGON River and Highway 13.

6
CONFIDENTIAL

CONFIDENTIAL

11

The purpose of the operation was to destroy the BINH DUONG Province Committee, and elements of Military Region Four (MR IV) and VC/NVA installations. Intelligence indicated the Viet Cong had logistical bases and installations in the area. These installations had been destroyed during Operation CEDAR FALLS and were rebuilt and reused by the VC immediately after Operation CEDAR FALLS terminated. During Operation MANHATTAN continued emphasis was placed upon the employment of the combined arms team of armor/mechanized and infantry forces. Although no major contacts were made with VC/NVA forces, substantial amounts of enemy arms, munitions, foodstuffs, and miscellaneous equipment were captured or destroyed. On 3 May 1967, at coordinates XT560390, a single arms cache, believed to be the largest encountered on the ground to date in the Vietnam War, was captured. The find included some 350 weapons and 314,450 rounds of assorted munitions. The operation terminated on 11 May 1967. Contact with the VC in the area of operations was light throughout the duration of the operation. One objective which was not achieved was the capture or destruction of the BINH DUONG Province Committee and elements of MR IV. Both armored ground forces and airmobile infantry moved with ease throughout the operational area, which indicates the VC decided to flee rather than fight to protect their material caches. The successful exploitation of information about caches from a CHIEU HOI from Operation CEDAR FALLS helped make the operation fruitful in finding enemy supply dumps. The operation resulted in 15 US KIA, 133 US WHA; 18 tanks, 9 APC's, 1 dozer, and 1 grader damaged; and 3 APC's and 1 5 ton wrecker destroyed. VC losses for the operation were 123 KIA (BC), 17 PW, 467 tons of rice, 1 ton cement, 1 ton of salt, 101 CBU's, 55 gallons of diesel oil, 2,838 lbs of TNT, 2,780 lbs of dried fish, 109 shaped charges, 1.1 tons of wheat, 5,261 mortar rounds, and 2,457 grenades. Equipment captured was 159 tons of rice, 1 US Starlight scope, 20 tons of salt, 430,548 rounds of small arms ammunition, 271 mortar rounds, 129 grenades, 472 mines, 10 bottles of penicillin, and miscellaneous items.

4. Operation DALLAS: Operation DALLAS commenced on 170534H May 1967 with the 1st Infantry Division reinforced by the 1-11th Armored Cavalry Regiment (OPCON 1st Div). On 12 May 1967 the Viet Cong launched a rocket attack on BIEN HOA Air Force Base using Soviet made 122mm rockets. Simultaneous mortar attacks were conducted on PHUOC VINH and TAN UYEN. In reaction to these attacks Operation DALLAS was conducted against VC/NVA forces and installations in an area extending east from Route 16, from the SONG BE River south to TAN UYEN and the ONG DONG Jungle, and the VINH LOI Woods to the west of Route 16. The operational area included the major VC routes of movement from War Zone D into the TAN UYEN/SAIGON area. Both airmobile and armor/mechanized forces were employed. The VINH LOI Woods, which had been a major VC base area, was destroyed by mechanized forces using Rome plows. The timing of the operation enabled the 1st Infantry Division to maintain forces astride the major VC supply routes, between War Zone D and the TAN UYEN/SAIGON area, during two Vietnamese holidays that included a 24 hour cease fire on the second holiday, thus deterring any movement and/or resupply along that route. Minor contact was made with enemy forces in the operational area. Although it would be entirely possible that the VC/NVA forces had left the area, there is a high probability that they remained. This probability is reinforced when one considers that the area had not been thoroughly searched for seven months, thereby allowing ample time for construction of base camps. If the validity of this probability is acceptable, one may conclude the VC/NVA will fight only at the time and place of his choosing. Apparently they were not prepared to counter the forces deployed in the operational area; therefore, they avoided contact. The operation was characterized by multi-battalion search and destroy operations that were successful in locating a number of small enemy base camps. Sporadic contact was made with the enemy. On 22 May the 1-11 ACZ made contact with an unknown size VC force resulting in 4 US KIA and 4 VC KIA (BC).

7
CONFIDENTIAL

CONFIDENTIAL

12

Later that day in the same area, vic XT026307, the same unit engaged a VC force and killed 3 VC (BC). The operation terminated at 250600H May 1967. Operation DALL'S resulted in 4 US KHA, 81 US WMA; 4 tanks, 5 APC's, 1 VTR, 2 UH-1D's, and 1 OH-13 damaged; 1 truck, 1 UH-1D, and 3 APC's destroyed. Enemy losses were 17 VC KIA (BC), 6 detainees; 20 tons of rice, 19 bottles of penicillin, 9 small arms, 515 rounds of small arms ammunition, 30 claymores, and 40 grenades captured; and 53 artillery/mortar rounds, 17 mines, 27 tons of rice, 104 bunkers, 30 lbs of peanuts and many miscellaneous items destroyed.

5. Operation BLUEFIELD: The 3d Brigade, 1st Infantry Division initiated Operation BLUEFIELD on 051100H June 1967 by making a multi-battalion combat assault to conduct combat reconnaissance and to destroy VC/NVA forces in an operational area that extended approximately 12 kilometers north and 13 kilometers northeast of LAI KHE, bounded by coordinates XT7440, XT7454, and east to the SONG BE River. The operation was intended to reassert the influence of the 1st Infantry Division in an area in which operations had not been conducted, in force, since October 1966. Intelligence indicated that the area was the scene of much Viet Cong activity prior to the operation. The division used one brigade headquarters, three infantry battalions, one infantry battalion (mechanized), and one cavalry squadron during the operation. A number of small base camps, tunnel complexes and one VC province headquarters (XT8646) were located along with the capture of moderate amounts of Viet Cong supplies and equipment. The operational area was characterized by a large amount of mines and booby traps. Many base camps had overhead cover on the bunkers and connecting tunnel systems. Some structures including tunnels had reinforced steel and concrete supports and evidence indicated some VC groups had recently departed the base camp prior to the arrival of friendly troops. This was evidenced by hot food and hot ashes. Friendly elements did not engage any sizeable VC units but did receive sporadic sniper fire indicating the VC chose not to defend their installations, but rather to deploy individual snipers and conduct harrasing activities. The size and type structures discovered indicated this area to be a possible "secure" area used by the VC for refitting and retraining of elements of the 273d VC Regiment and possibly other elements of the 9th VC Division. As a result of the operation, the division was able to insure that there was no large enemy force within rocket/mortar range of FHUOC VINH or LAI KHE in the operational area. The operation terminated 091500H June 1967. Operation BLUEFIELD resulted in 1 US KHA, 2 US WMA and no US equipment losses. The VC losses were 1 VC KIA (BC), 23 small arms, 2 hand grenades (CHICOM), 311 rounds of small arms ammunition captured; 139 CHICOM hand grenades, 11 57mm rounds, 100 blasting caps and miscellaneous items destroyed.

6. Operation BILLINGS: The 1st Infantry Division initiated its first major operation in War Zone D on 121144H June 1967. The purpose of the operation was twofold; first, to locate and destroy the 271st VC Regt and second, to search the area north of FHUOC VINH to destroy base camps and enemy forces in the area of interest and provide security to FHUOC VINH. The general area of operations extended from FHUOC VINH north to CON LUAN and from three thousand meters west of the SONG BE River east to the LACH MAT and SUOI HUR Rivers. During the operation, the 1st Infantry Division employed two brigade headquarters, eight infantry battalions, and one cavalry squadron. Prior to the operation intelligence reports indicated that since the 1st of April 1967 there had been numerous reported VC unit sightings in the area of interest. A total of 7 battalion, 9 regimental and 1 divisional headquarters unit sightings had been reported. Units of the 1st Infantry Division made contact twice with elements of the 271st VC Regt that were in the operational area. The first battle occurred on 14 June when a rifle company moved into a VC base camp area at XT9366 that had been bombed by a B-52 raid 48 hours earlier. After a sharp meeting engagement the VC withdrew. The second battle occurred on 17 June 1967. Both battles were fought near XCM BC (XT9668). The conflict began in the afternoon when two US infantry battalions were moving from south

8

CONFIDENTIAL

13

CONFIDENTIAL

to north into a landing zone. As the two battalions prepared to dig in and patrol their immediate front before nightfall, they began to receive sporadic enemy fire from the west. The enemy fire built up rapidly and soon a main VC attack was launched from the north. A second attack was launched from the south minutes later. Small unit probing by the VC was conducted all around the landing zone. Snipers from the trees began to fire into the landing zone. Sixty millimeter mortars positioned 600 meters northeast of the landing zone began firing into the area. The contact lasted for about 45 minutes. A quick search of the wood line around the landing zone yielded a wounded VC. Through interrogation and from documents in his possession it was determined that the 1st Battalion of the 271st VC Regt launched the attack. The wounded PW stated that his unit was to assemble approximately 4 kilometers northwest of the landing zone. Documents taken from a dead VC contained a sketch map of a stream line with unit identification indicating their assembly position. From the information taken from the PW and the sketch maps, the VC assembly area was located and artillery and airstrikes were placed into the area. Enemy losses during the encounter were 60 VC KIA (BC) on 14 June 1967 and 222 VC KIA (LC) on 17 June 1967. The rest of the operation did not result in any significant enemy contact. Of significance is the fact that existing landing zones were improved and enlarged and Route 14 north of THUC VINH was improved. VC base camps and way stations in the northern area of interest for the security of THUC VINH were located and destroyed. Particular emphasis was placed upon the destruction of such installations along the east-west line of VC communications from War Zone C to War Zone D. Valuable information was gained of the area which will support future operations in War Zone D. Of particular significance was the acquiring of an appreciation of the limiting factors of operating in War Zone D. The type of jungle encountered was considerably denser than that previously operated in by the Division. Fewer open areas suitable for use as landing zones exist in War Zone D. The operation terminated on 261838H June 1967. The results of the operation were 57 US KIA, 197 US WIA, 347 VC KIA (BC), 1 PW, 1 detainee, 3 small arms, 1 RPG-2, 4 machine guns, 17 grenades, 2 tons of rice, 16 base camps, 338 fighting bunkers, 38 military structures, 511 rounds of small arms ammunition, and miscellaneous items.

7. Unnamed Operations after BILLINGS

a. AC STRIKE: After Operation DALLAS, continued interest was shown in AC STRIKE, the same area covered in Operation DALLAS. A minimum of one infantry battalion operated in the area. Joint allied operations with ARVN marines were conducted in the area. During July the 1st Brigade operated with a total of five battalions in AC STRIKE from a forward command post located at TAN UYEN. On 18 July 1967 via YTO59286 the 1-2 Infantry made contact with an unknown size force of VC in a base camp. Claymores and mines were effectively used by the VC against the attacking US troops. As a result of the contact there were 7 US KIA, 28 US WIA, and 5 VC KIA (BC). Artillery and airstrikes placed in the area are believed to have inflicted a larger number of casualties upon the enemy, but the density of the jungle did not permit aerial observation of the withdrawing enemy force.

b. Highway 13: After Operation BILLINGS the 3d Brigade conducted a major road clearing operation between LAI KHE and QUAN LOI along with search and destroy operations in the brigade TAG and overwatch of Special Forces Camps in the brigade TAGI. On 11 July 1967 QUAN LOI, AN LC and the ARVN outpost at TAN HUNG came under mortar/rocketless rifle attacks. At QUAN LOI a ground raid by VC to attempt to destroy the artillery and to divert US attention was conducted resulting in

CONFIDENTIAL

CONFIDENTIAL

14

7 US KHA and 27 US WHA. Enemy losses were 7 VC KIA (BC). Meanwhile the 141st NVA Regiment conducted a major assault against two companies of the 2-9 ARVN Infantry at TAM HUNG. Artillery from QUAN LOI to include 1st Division Forward Air Controllers (FAC) gave fire support to the ARVN. This action resulted in 119 NVA KIA (BC). On 14 July QUAN LOI received 30 rounds of 82mm mortar fire resulting in 6 US KHA and 11 US WHA. VC casualties are unknown.

c. Mortar/Rocket attacks: On 27 July the 1st Brigade base camp at PHUOC VINH came under mortar and rocket attack. A total of 73 82mm mortar rounds and 86 122mm rocket rounds were received. This was the first time that a 1st Infantry Division unit had received a rocket attack from VC/NVA forces in Vietnam. US casualties were 12 US KHA and 72 US WHA. A reaction force sent out to clear the rocket launching area located the rocket positions as well as two dead and two wounded VC from the 271st VC Regiment. Again on 29 July the Division Artillery base camp at PHU LOI, within the 2d Brigade's TAOÑ, came under mortar and rocket attack. A total of 200 82mm mortar and 49 122mm rocket rounds were received. US casualties were 2 US KHA and 63 US WHA.

8. Operation LAM SON 67: As reported in previous reports Operation LAM SON continues. Of particular significance is the name LAM SON itself and its history which has not been mentioned in previous reports. In the year 1406 the Chinese, then under the MING Dynasty (1368-1644), for the second time, invaded Vietnam. The country was heavily exploited, and measures were instituted to force the Vietnamese people to accept Chinese customs and traditions. In 1427 a Vietnamese aristocrat named LE LOI organized an army and rallied it at a mountain named LAM SON in THANH HOA Province in north-central Vietnam. This mountain was used as a staging area against the Chinese tyrants from 1406-1437. LE LOI's army fought the Chinese using guerrilla tactics and eventually defeated the Chinese in 1437. The name LAM SON today has the connotation of protecting the Republic of Vietnam from the North Vietnamese and the Viet Cong in order to preserve its independence and not be subverted by Red Chinese influence from the north. Thus the name LAM SON is really more than a name--it reflects the strong nationalistic attitude of the South Vietnamese. Because the 1st Infantry Division is supporting the Vietnamese people maintain their independence the name LAM SON was chosen for the division's Revolutionary Development Support Operation LAM SON.

During this reporting period Operation LAM SON 67 which started 080701H February 1967 was continued under the control of the 2d Brigade, 1st Infantry Division. A detailed account of the operation is found in the 2d Brigade Operational Report on Lessons Learned, dated 6 August 1967.

During the reporting period intelligence support of the Revolutionary Development Program was centered around the task of devising an organization and system that would provide rapid, accurate, and updated information on any phase of intelligence in the LAM SON area. To provide this, an information folder was prepared on each village and hamlet in the LAM SON area. The group consists of 179 folders and each contains a black list, VC incidents, agent reports, coordination reports (information obtained from other agencies), census, grievances, history of friendly operations, economic importance, capability of food production, and an aerial photograph or schematic drawing of the village or hamlet. Each folder is updated daily and reviewed weekly. This information is made available to any unit on a need to know basis. A supplementary intelligence report is prepared daily. All information of an intelligence nature on the LAM SON area is compiled into one report and disseminated into ARVN and Allied agencies in the immediate III Corps area on a need to know basis. An Order of Battle booklet on major units in the LAM SON area has been prepared and contains AKA's, type weapon and number in each unit, tactics used in the past, personalities, and all battles and their results. Also a unit location OB is maintained on maps in order that routes and patterns of units can be traced.

CONFIDENTIAL

CONFIDENTIAL

15
During the period, the availability of information on VC infrastructure increased, particularly in the area of cover and letter box numbers. The logical and orderly organization of this material has resulted in a wider dissemination of the information and has made it readily available for retrieval. A very complete personality file has been initiated which covers the LAM SON area. The file consists of information on an individual's age, sex, job in the VC unit, past assignments, and any other pertinent information that may be helpful in identifying him and his actions. The infrastructure is updated daily and is cross filed by unit, village, hamlet, and area in alphabetical order.

Modification of the Revolutionary Development Support Program took place during the month of May 1967 with the organization of a "Country Team" in an attempt to lend direction and unity to the efforts of civilian and military agencies in creating a visible atmosphere of security to permit nation building. The "Country Team", composed of representatives of the Provincial Office of Civilian Operations, BINH DUONG Sector, 5th ARVN Division, and the 2d Brigade, was organized and will meet bi-monthly in an attempt to unify the assets, expertise, and plans of the civil and military agencies towards insuring the success of the Revolutionary Development Program. Joint committees and planning groups have been organized to establish priorities of interest and to orient the military and civil operations into a unified effort. The immediate evaluation of this organization cannot be made at this time, however, it is anticipated that a major improvement will be realized in future Revolutionary Development activities.

CONFIDENTIAL

CONFIDENTIAL

E. Training

1. For the period 1 May - 31 July 1967 the following is the breakdown of battalion days which units spent in training, troop movements, and operations:

	OPN: LAM SON 67	MANHATTAN	DALLAS	BLUEFIELD	BILLINGS	HARVEST MOON	OTHER
MAY	65	39	27	0	0	9	170
JUN	58	0	0	19	72	0	151
JUL	71	0	0	0	0	0	239
Total	194	39	27	19	72	9	560

2. Listed below is a breakdown of battalion days by mission:

	S&D OPNS	ROAD SCTY	BASE SCTY	S&S OPS	EN ROUTE	CARE & MAINT
MAY	89	56	131	10	13	11
JUNE	57	43	168	4	26	2
JULY	81	16	179	11	23	0
Total	227	115	478	25	62	13

3. The training posture of the division remained excellent during the reporting period. The major training activities conducted were as follows:

a. Replacement Training: This program has been reorganized. It consists of a 61 hour course, 75% of which is practical work. Twenty per cent of the training is conducted at night. The following number of men attended replacement training during the reporting period:

1st Brigade	679
2d Brigade	503
3d Brigade	618
Div Arty	722
Spt Cmt	780
TOTAL	3,302

b. Fourth Rifle Company Training: The division received its fourth rifle company packets during the month of July. These companies began a 75 day training period which started with individual environmental training. This is being followed by unit training (squad, platoon, and company) and will culminate with the gradual introduction of these units into ever more demanding combat roles until they are fully integrated into divisional operations.

c. Mobile Training Team: The division has organized this team to train small unit leaders. The MTT conducts training at battalion locations during periods of stand down. One officer and 5 NCO's, all combat experienced, conduct this training, which consists of three days of lectures and practical work. Subjects covered are: ambush, patrolling, weapons, defense, movement, and inspection as applicable to a junior leader's responsibility to his men, equipment and mission. During the reporting period each Inf/Mech battalion has been visited at least once by the MTT. A total of approximately 1,100 junior leaders have received this training. The program has been enthusiastically received by commanders, staffs, and men.

d. RF Company Training: Under the direction of III CTZ and IIFV an experimental training program is being conducted by this division

CONFIDENTIAL

CONFIDENTIAL

for a newly formed RF Company. The training commenced on 10 July 1967 and consists of a 17 week cycle of AIT, BCT and BUT. Training is conducted at the 5th ARVN Division Training Center at PHU VAN. Eight US personnel and six interpreters conduct the majority of the training. Once the company is trained, it will be deployed in BINH CCNG Province, with certain US personnel to remain on site with it until it is well established.

e. Mobile Advisory Teams: This is another experimental program organized under the direction of III CTZ and IIFV. This division has provided 3 teams, each consisting of 1 officer and 3 EM, to the program. Each team is co-located with an RF/PF unit. Each is under the direct control of the sub-sector advisor and has the mission of improving the status of training and security of its RF/PF unit.

f. TDY Schools in and out of Vietnam: Schools and number of personnel attending are listed below:

RECONFO	60 EM
AAMT...	48 EM
JUSPAC	1 OFF
SURVIV L	5 EM
ARC 131	2 EM
PSYOPS	2 OFF, 1 EM
M-548	5 EM
AN/PFR-5, AN/PRT-4	1 OFF, 13 EM
AN/USC-2	37 EM
AN/CRC 106	36 EM

g. Miscellaneous Division Conducted Training Programs:

Sniper School	58
Chinook Load Rigging	28

F. Psychological Operations and Civic Action, Revolutionary Development Support

1. General: During the past quarter the ACoS, G-5 continued to exercise staff planning and supervision over brigade S-5's. During June the G-5 assumed responsibility for all division civic action support. The 2d Brigade returned the printing press to the division G-5 which they obtained when they absorbed the Revolutionary Development Task Force during the previous quarter. One officer, two NCO's and two EM were transferred from the 2d Brigade S-5 section to the G-5 to operate the civic action support warehouse and the division's 1,250 W multilith printing press. The division received a model 85 multilith printing press, a paper cutter, a Vietnamese typewriter, and a Polaroid model 180 camera for quick reaction to psyops requirements. As of 31 July the division has not received the platemaker component for the printing press. The press will not be operable until the platemaker is received.

2. Psychological Operations (Psyops)

a. The most significant psychological operations effort during this reporting period occurred as a result of Viet Cong road cutting activities around AN LOC during the early morning hours of 11 July 1967. At this time the division G-5 had completed initial studies, developed notes and a rough outline for an extended psychological operations campaign along Highway 13 from SAIGON to the Cambodian border. The report of the Viet Cong activity reached the G-5 during the mid-afternoon of 11 July 1967. At 0830 hours the following morning 50,000 specially written leaflets were distributed on each village in the AN LOC area affected by the Viet Cong road cuts. Leaflet distribution was carried out with pin point accuracy by U-10 aircraft flying at tree top level. Taking into account such factors as message, timeliness, speed, accuracy of distribution,

CONFIDENTIAL

CONFIDENTIAL

Viet Cong interests involved, area-wide psychological significance, and vulnerability of target audience, this operation was well executed and gave the personnel concerned better knowledge of the working mechanics of a standard operating procedure.

b. On 27 June a Viet Cong mine destroyed a civilian bus near the village of AP BO LA (XT8044). Thirty-five civilians were killed and ten others were injured. 1st Infantry Division Psychological Operations personnel were rushed to the scene in order to secure photographs and accurate information to exploit the Viet Cong atrocity. Three exploitation leaflets were written and designed at the division. Four hundred and fifty thousand copies were distributed in villages along major roads in the area of the incident.

c. Throughout the reporting period the division flew a total of 669 psychological operations missions. A total of 21,143,500 leaflets were distributed. The monthly breakdown is: May - 6,104,500; June - 6,863,000; July - 8,176,000. A total of 413 1/2 hours of aerial loudspeaker broadcasts were also made by the division.

d. Forty special messages to exploit or support the local current situation were developed during the reporting period. Seven leaflets were directed at the following target audiences: two leaflets - 271st VC Regiment; three leaflets - 27 June bus incident; two leaflets - Highway 13. The remaining 33 special messages were loudspeaker tapes produced primarily to exploit ralliers under the National CHIEU HOI Program.

e. In support of Operation LAM SON a total of 5,275,000 leaflets were distributed and 298.6 hours of aerial loudspeaker broadcasts were completed during the reporting period. In support of Operation BILLINGS 3,180,000 leaflets were distributed and 19 hours of broadcasts were completed.

f. Psychological Operations Assets in terms of equipment were increased starting in June when a portable Psyops loudspeaker was acquired. This loudspeaker has an output of 25 watts and is easily carried by one man. In July the 246th Psyops Company provided an audio-visual truck for showing movies, film strips and slides as well as making loud-speaker appeals. The unit is completely self-contained, needing no external power source.

3. Civic Action

a. During the reporting period 25,934 persons were treated under the 1st Division MEDCAP/DENTCAP Programs. An additional 3,036 persons were given classes on hygiene and numerous patients were treated in Vietnamese facilities where US personnel assisted. The July total represents the largest monthly total reported this year and is believed to be the largest monthly total to date. A breakdown is given below:

	<u>May</u>	<u>June</u>	<u>July</u>
1st Brigade	1,493	1,571	1,610
2d Brigade	1,685	3,349	7,970
3d Brigade	2,664	1,419	2,297
Spt Cmd	467	496	523
Div Arty	0	0	390
TOTALS	<u>6,309</u>	<u>6,835</u>	<u>12,790</u>

b. Commodity distribution remained high. An estimated minimum of 170 tons of rice, 66 tons of other foodstuffs, and 3,000 cases of various assorted commodities were distributed to schools, orphanages,

CONFIDENTIAL

CONFIDENTIAL

hospitals, churches, other worthwhile causes, and during the hamlet festival operations. Numerous small personal gift type items and various kits (school, health, textile, sewing, midwife, and physical education) were also distributed. However, no captured foodstuffs were turned over to the G-5 for distribution during this reporting period.

c. During the reporting period action was taken to obtain assistance cooperation, commodities, and other items available through such agencies and organizations as USAID, CARE, International Rescue Service, and the Catholic Relief Society. A close working arrangement is now in effect between the division and the above groups.

4. Civil Affairs.

a. In June the 1st Division Commanding General published Commander's Note number 6, prepared by the CG and concerning the disposition of Vietnamese private property, and the required procedures relative to search and seizure of Vietnamese private dwellings. The basic guidance set forth was that the disposition of private property in Vietnam and search and seizure of such property is the responsibility of the Vietnamese Government; and that civilian dwellings and other private property, including livestock, will not be destroyed or damaged except as the unavoidable consequence of combat operations.

b. On 27 June 1967 near the village of AP BO LA a Viet Cong mine destroyed a civilian bus killing over 35, and injuring ten persons. 1st Division personnel provided immediate medical assistance and evacuation to hospital facilities for injured persons. In addition substantial assistance was given to GVN authorities in removal, identification, and in several instances, burial of the dead. Aside from the psychological exploitation of this incident the contrast in behavior between the Viet Cong and US fighting men was widely advertised by word of mouth. The remains of several persons were delivered to both BIEN HOA and LAI THIEU; and following a necessary display of the bodies for identification purposes, a spontaneous anti-Viet Cong demonstration broke out in PHUOC VINH the day following the incident. One thing which made this incident particularly atrocious was that the large majority of passengers were women and children.

c. It is estimated by the G-5 that fewer serious incidents involving US/VN personnel occurred than in previous quarters. With one exception there is no evidence that any incidents had an adverse effect on the civilian population in the area. In all known instances the Division Provost Marshall conducted prompt investigations, while other Division representatives paid immediate condolence visits and quickly made solatium payments. Arrangements were made for the return of certain property to rightful Vietnamese owners. Since the issuance of Commander's Note number 6, no major Vietnamese complaints as to breaches of policy relative to Vietnamese property were received by the G-5.

5. Revolutionary Development

a. All Psyops activities have included material explaining GVN objectives or accomplishments; and all Civic Actions have been directed toward widening popular support for the GVN and improving its public image. Particularly in the efforts which have been made in Psyops intelligence, planning, analysis, and in improving reporting systems, means have been sought to better identify the proper objectives and more accurately measure the progress and effectiveness of on-going efforts.

CONFIDENTIAL

CONFIDENTIAL

20

b. All activities set forth elsewhere in this report affect Revolutionary Development directly or indirectly.

G. Personnel and Administration

1. Personnel:

a. Strength:

	OFF	WO	EM	AGG
Authorized 1 May 67	947	166	14,375	15,488
Authorized 31 July 67	1,011	166	15,421	16,598
Assigned 1 May 67	1,003	129	16,496	17,628
Assigned 31 July 67	961	121	17,432	18,494

b. Gains, qualifications and status:

(1) Gains:

(a) There were 5,171 replacements to duty during the quarter.

(b) There were 1,461 persons returned to duty during the quarter.

(2) Qualifications: A significant number of replacements are being received in grades lower than those requisitioned, particularly lieutenants for captains in Infantry and Artillery, and there is a resulting lack of experience in key positions.

(3) Status: Replacements received in the lower enlisted grades are in excess of requirements.

c. Losses:

(1) There were 4,498 losses during the quarter due to reassignments within Vietnam, rotations, ETS, and board actions.

(2) Losses due to casualties were as follows:

(a) May	OFF	WO	EM	AGG
KHA	3	0	17	20
WHA	10	0	236	246
NBD	0	0	6	6
NBM	0	0	50	50

(b) June

KHA	4	0	48	52
WHA	13	1	281	295
NBD	3	0	2	5
NBM	1	0	35	36

(c) July

KHA	2	0	45	47
WHA	11	5	231	247
NBD	0	0	4	4
NBM	2	0	40	42

CONFIDENTIAL

CONFIDENTIAL**2. Discipline, Law and Order:**

a. The discipline in the division has been excellent the past quarter. There were no stragglers apprehended. There were 16 serious incidents and 147 AWOL's reported during the period.

b. There were 9 General Courts-Martial tried during this quarter. A total of 118 records of trial for Special Courts-Martial and 19 records of trial for Summary Courts-Martial were received for review.

c. The division IG handled 130 requests for assistance and 25 complaints, 7 of which were justified.

3. Graves Registration: During the quarter the Graves Registration Platoon processed and evacuated 134 remains.

4. Development and Maintenance of Morale:

a. Finance: Four new units assigned to the division were processed by sending processing teams to the unit location, resulting in greater efficiency and less inconvenience than previous processing methods.

b. Chaplain: During the quarter there were 1,518 religious services conducted with a total attendance of 52,384.

c. Special Services: During the quarter 3,810 out-of-country and 885 in-country R&R allocations were utilized. There were 12 USO shows performed during the quarter.

d. Awards and Decorations:

Congressional Medal of Honor	1
Distinguished Service Cross	6
Distinguished Service Medal	1
Legion of Merit	38
Silver Star	177
Soldier's Medal	60
Distinguished Flying Medal	132
Bronze Star - Valor	681
Bronze Star - Merit	1,811
Air Medal - Valor	107
Air Medal - Merit	1,423
Army Commendation Medal - Valor	502
Army Commendation Medal - Merit	2,693
Purple Heart	388
TOTAL	8,019

5. Civilian Personnel:

a. At the end of the quarter the division employed 903 temporary hire local nationals.

b. There were 1,416 permanent hire local nationals employed at the end of the quarter.

H. Logistics: The logistical activity of the 1st Infantry Division during the reporting period is contained in the Support Company ORLL, at Inclosure 6.

CONFIDENTIAL

CONFIDENTIAL

12

II. Commander's Observation and Recommendations

A. OBSERVATIONS (LESSONS LEARNED)

PHYSICAL PROFILES

✓ ITEM: There are personnel being assigned to the Division with physical profiles precluding utilization in combat elements.

DISCUSSION: HQ, USARV has authorized immediate reassignment of such individuals but the administrative excess and loss of man days is significant. A limited number of profiled personnel can be utilized within base camp and support type activities.

OBSERVATION: A thorough screening of personnel records at transfer stations and processing centers for physical profiles prior to assignment to Division would preclude many problems.

AERIAL LOUDSPEAKERS

ITEM: Use of Aerial Loudspeakers

DISCUSSION: Aerial loudspeakers are used during cordon and search operations to provide guidance from the tactical unit commander to the civilian population of the village being sealed. Specific instructions to the villagers are broadcasted telling them their village is sealed, to remain in the village and not to attempt to leave the village.

OBSERVATION: The use of aerial loudspeakers in addition to ground loudspeakers during cordon and search operations is of value to inform the civilian population of the tactical commander's desires, thereby reducing casualties among the village population.

ROAD OUTPOSTING

ITEM: Road outpostting methods

DISCUSSION: It has been determined that acceptable road outpostting methods vary almost exclusively with fields of fire and foliage in the proximity of the road.

OBSERVATION: When the foliage in the proximity of the road is light and good fields of fire are available, road outpostting procedures are rather flexible. Vehicles may be alternated on each side of the road so they have visual contact with each other. Dismounted LP's are then deployed behind the vehicles to afford rear security. Inter vehicular distance must be varied with the terrain.

Example:

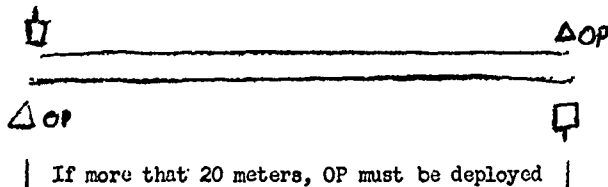

CONFIDENTIAL

23

CONFIDENTIAL

When fields of fire are limited due to foliage and terrain, back to back outposting is the most suitable. This method uses two vehicles sited directly opposite one another on either side of the road. This provides excellent all around security, decreases reaction time, and permits immediate return of enemy fire.

Example:

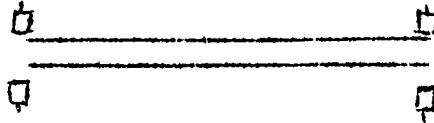
MINE SWEEPING OPERATIONS

ITEM: Mine sweeping sweeping techniques in heavily mined areas.

DISCUSSION: When deployed in the V-formation, tanks should be used as flank security.

OBSERVATION: Due to the increased frequency of off the road mining we have limited flank security to tanks. The added protection against mines inherent in the tank curtains injuries and minimizes material damage.

ACAV's will be kept on the road behind the mine sweeping teams and lead tanks.

Example:

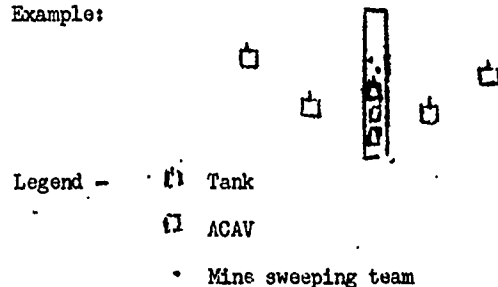

Legend -

- Tank
- ACAV
- Mine sweeping team

COMMUNICATIONS

ITEM: Extra PRC-25 radios

DISCUSSION: Due to various commitments given cavalry platoons it is necessary for platoon leaders to carry an extra PRC-25.

OBSERVATION: Frequently the platoon leader is required to organize and deploy dismounted patrols. Each patrol must have radio communications. To facilitate this an extra PRC-25 will be carried by each platoon.

ILLUMINATION

ITEM: Illumination coordination required for Night Defensive Positions.

DISCUSSION: Illumination coordination between units of an NDP is necessary to coordinate the positioning of starlight scopes and xenon searchlights. This insures well dispersed observation capabilities throughout the perimeter. Preplanned artillery illumination will be utilized when there is not sufficient light for the proper employment of the starlight scope. This artillery illumination should be placed between 5,000 meters and 6,000 meters from the NDP. This eliminates illuminating the NDP.

19

CONFIDENTIAL

CONFIDENTIAL

24

VC TACTICS

ITEM: VC Tactics

DISCUSSION: During Operation BILLINGS the VC/NVA forces fought in a way that indicated they are learning to fight US forces in a more professional manner. Their troop discipline under fire, their ability to coordinate their attacks, indicates improvement in their leadership. Captured VC documents indicate the following future tactical innovations to be conducted by the VC.

1. The use of a small decoy to lure US units into an ambush by VC major forces.
2. Emphasis upon attacking US forces during airmobile extraction operations.
3. An intensification in the conduct of raids and ambushes.
4. Increased emphasis upon the destruction of the initial element of an airmobile assault. Such tactics require that increased emphasis on vigilance, control, and security be exercised by commanders of all levels.

OBSERVATION: Commanders should remain alert for new or better use of recent tactics to be employed by the VC.

BOUNDARIES

ITEM: Division Boundaries

DISCUSSION: During Operation MANHATTAN the 1st Infantry Division and the 25th Infantry Division moved toward each other with the SAIGON River as a division boundary. In this instance, liaison officers were exchanged down to and including battalion level to provide for continuing fire coordination.

OBSERVATION: It is necessary to establish and maintain close coordination between units that are moving toward each other, even when the boundary between the two units is a clearly defined terrain feature.

PW's

ITEM: Use of PW's

DISCUSSION: On two occasions during Operation MANHATTAN information obtained from PW's led to the capture of two large VC weapons and munitions caches, one of which was at the time the largest known discovery of its kind in the Vietnamese War. The information was provided by two former VC officers, who were captured during previous battles. These individuals also volunteered their services to the IPW teams to assist in gaining information of immediate tactical value from new PW's.

OBSERVATION: The establishment of rapport as a result of IPW personnel's persistent effort to gain the confidence of the PW's provides a valuable intelligence tool that needs more exploitation.

CONFIDENTIAL

25-
CONFIDENTIAL

INTELLIGENCE

ITEM: Intelligence Dissemination

DISCUSSION: The effort of painstakingly compiling and disseminating intelligence in a concise, graphic form permitted smaller units to conduct detailed planning of their operations. The results achieved in locating VC supply caches, base camps, and tunnels at reported sites validated the method employed by the 1st Infantry Division's intelligence staff.

OBSERVATION: The intelligence staff has developed an intelligence system that focuses upon all facets of VC activity in II Corps Tactical Zone, maintains cross reference files that provide specific detailed information on any given aspect of VC organizations and operations anywhere in the zone, and collates detailed information to develop VC trends and patterns of activities.

PATROLS

ITEM: Ambush Patrols

DISCUSSION: The ambush offers the infantryman the greatest potential. Practically every day 1st Infantry Division ambushes make contact with VC; however, the resultant body count is unacceptably low. Increased emphasis and training is necessary to improve the ambush techniques.

OBSERVATION: The 1st Infantry Division has prepared a training letter, subject: Ambush, dated 5 August 1967, which is inclosed with this report as Inclosure 12.

ASSAULTS

ITEM: Airmobile Assaults

DISCUSSION: Much experience has been gained by the 1st Infantry Division since it arrived in Vietnam. The airmobile assault has proven itself to be a valuable tool in combating the VC and chasing him out of areas considered to be his jungle sanctuaries.

OBSERVATION: The following comments are lessons learned through experience:

The first problem in an airmobile assault is to select the LZ. The LZ that is selected should be one that can be easily prepared and sealed off. The airstrikes that prepare the LZ should use hard bombs and napalm. The time for four flights of TAC air should be compressed as tight as possible. (See Diagram 1, page 23)

In the artillery preparation there must be thorough coverage of the LZ. One must be concerned with killing anyone around the LZ. The air and artillery must use a system of blocking out the positions for the preparation. If the airstrike is off the desired target area then more artillery must be put in. Orbits must be established for aircraft that are involved in the prep. An altitude space from 1,500 feet and below is given to the FAC, while an altitude of 1,600 feet and above is given to commanders and other observers (called "strap-hangers"). (See Diagram 2, page 24)

Whenever the LZ cannot be covered with fire then cover it with smoke. This will act as a cover. (See Diagram 3, page 25)

The five initial ships should go into the LZ one minute early, landing about 100 yards from the trees for the sole purpose of returning fire. (See Diagram 4, page 26)

CONFIDENTIAL

CONFIDENTIAL

26

Blocking fires should be set up out to the flanks on one, two, or three sides, depending on the situation. It is extremely important that all people know where the blocking fires are being placed. The brigade commander is responsible for all fires. He must inform his people of these blocking fires. Airstrikes are used to prep the "in" run while artillery is used to prep the "out" run. The troops ship pilots must know exactly where to land the first platoon. The LZ should be large enough to hold the headquarters and all platoons. Upon landing the troops must quickly leave the helicopters and go directly to cover. The first man off each ship directs the people in the platoon as to when they are to go. The second platoon should be landed in an area far enough away to prevent congestion. It is important that companies are separated and that there is a guide for each platoon. (See Diagram 5, page 27)

The troop locations on landing should be marked by colored smoke. Smoke is important, but one should not spend all the time on the radio talking about it. When using smoke, you have to cover your flanks with smoke and give the people in the air an idea, a picture, of the disposition of the unit. Enough smoke must be used to outline the troop positions.

A simple movement plan must be tied in with the night defensive position (NDP) plan. Everyone must understand ahead of time what is going to happen. The best remain over night (RON) position is where you have a clearing all around you with a good position for resupply. A good defensive position and readily secured resupply area is needed. Security is a most vital part of the plan.

Problems have been experienced on assaults with people failing to mark the extremities with smoke, failing to double-time off the LZ, and with the grouping of men. The reason for the bunching of men is that no one knows the assembly plan.

The brigade commander should carry the battalion commander in his ship, so that he has positive control of all facets of the plan. Also, closer coordination in keeping the operation on schedule is facilitated. If one has a delay, all have a delay; everyone concerned must know about it so that the men don't overload. Reconnaissance platoons are not to be used as companies. One should make sure that their mission is within the capabilities of a platoon.

In the extraction plan from an LZ blocking areas should be in the area of the greatest threat. In the platoons, during extraction, everyone must be dispersed except the 1st chalk where everyone should be standing up ready to load immediately onto the aircraft. The detonation of claymores should be judged by the time it will take to extract. The claymores will possibly clean out VC troops who may be moving immediately into fighting positions to get at the last aircraft. Three major guides to an airmobile assault plan are: 1. Keep it simple, 2. Thorough briefing, 3. Vigorous supervision - the most important point.

22

CONFIDENTIAL

A1

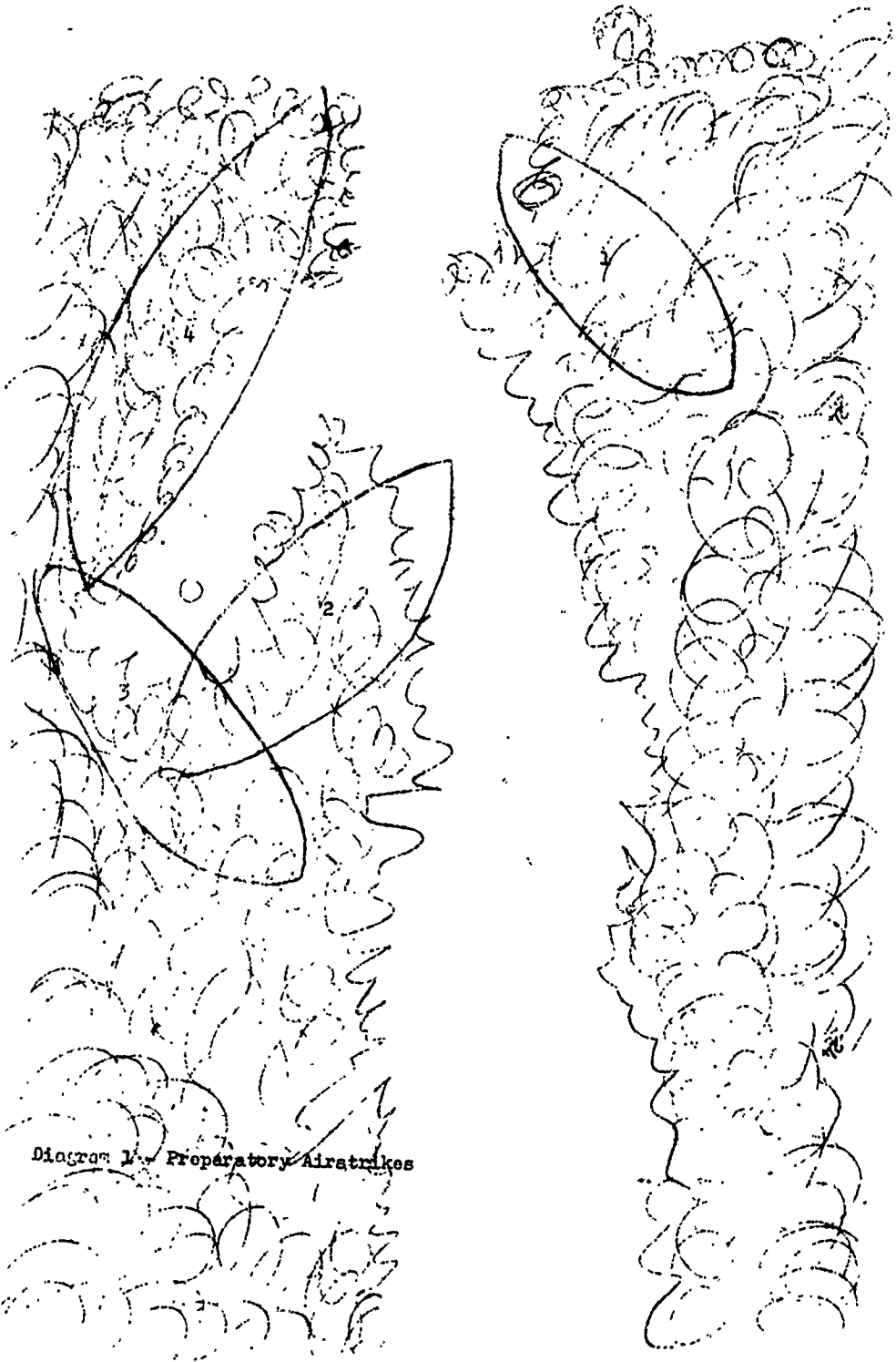
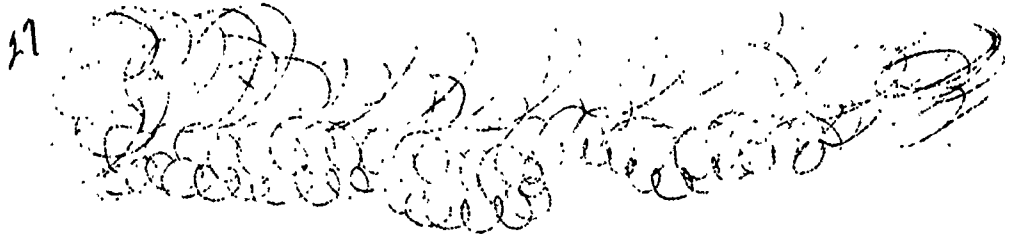

Diagram 1. Preparatory Airstrikes

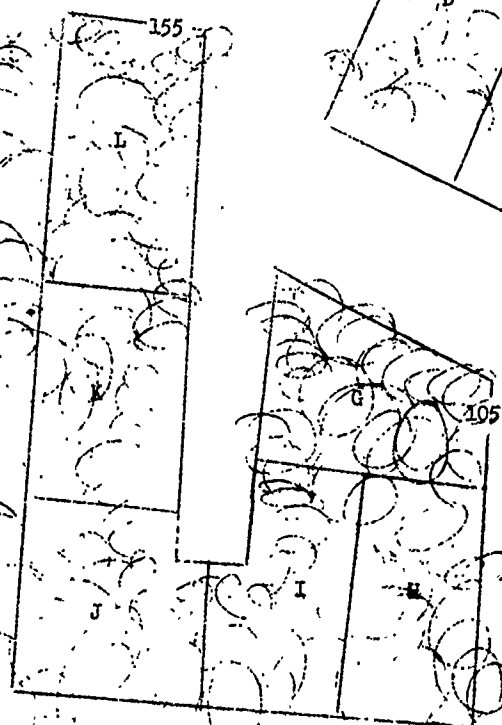
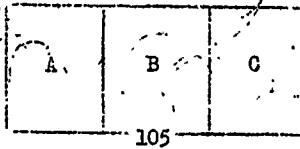
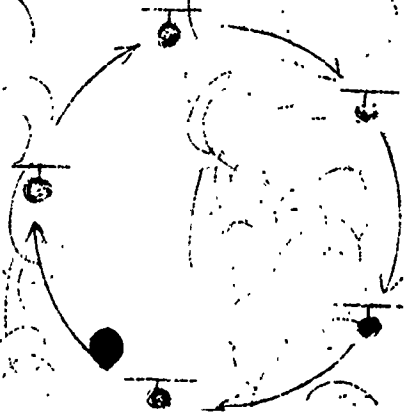

Diagram 2 - Artillery Preparation



29

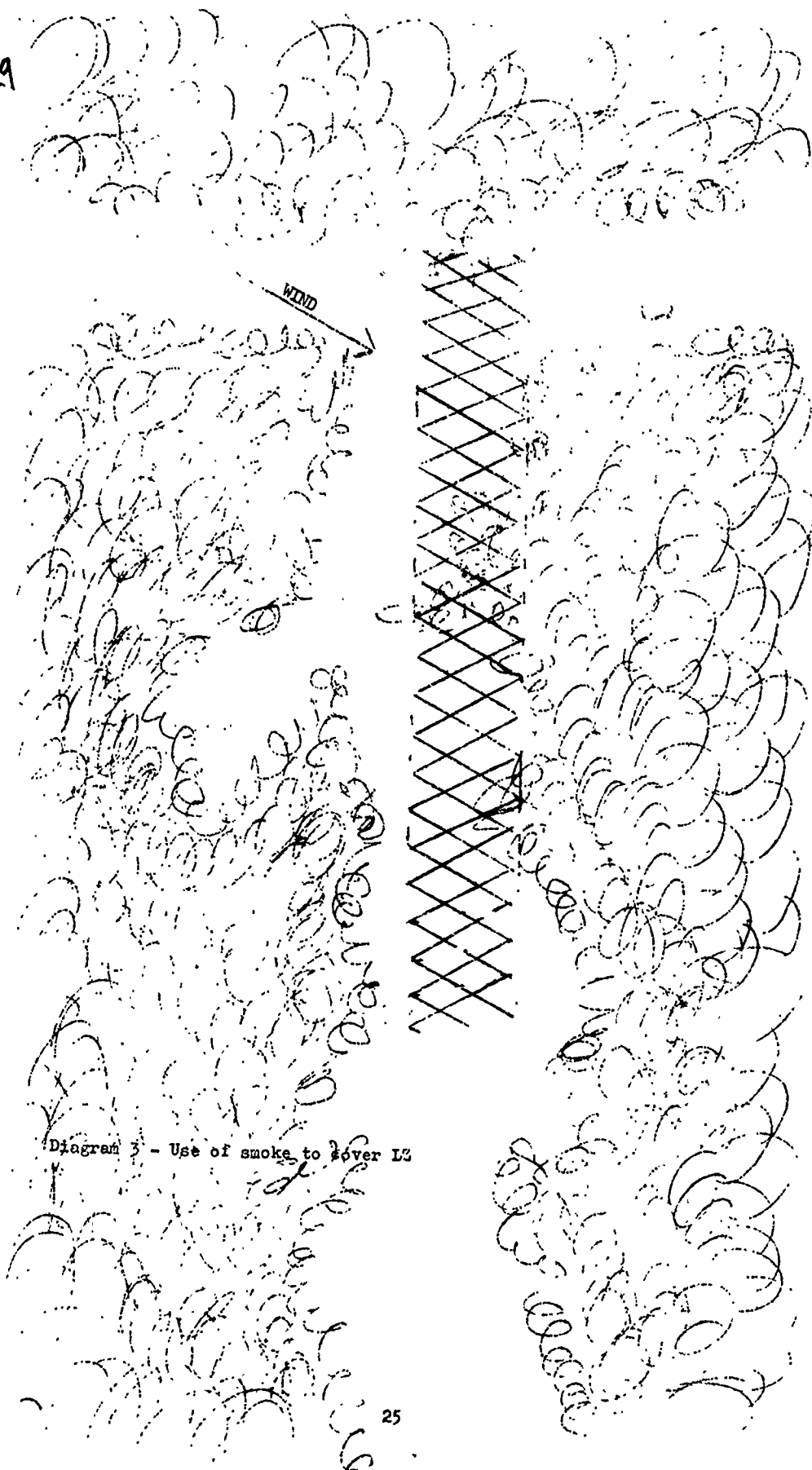

Diagram 3 - Use of smoke to cover LZ

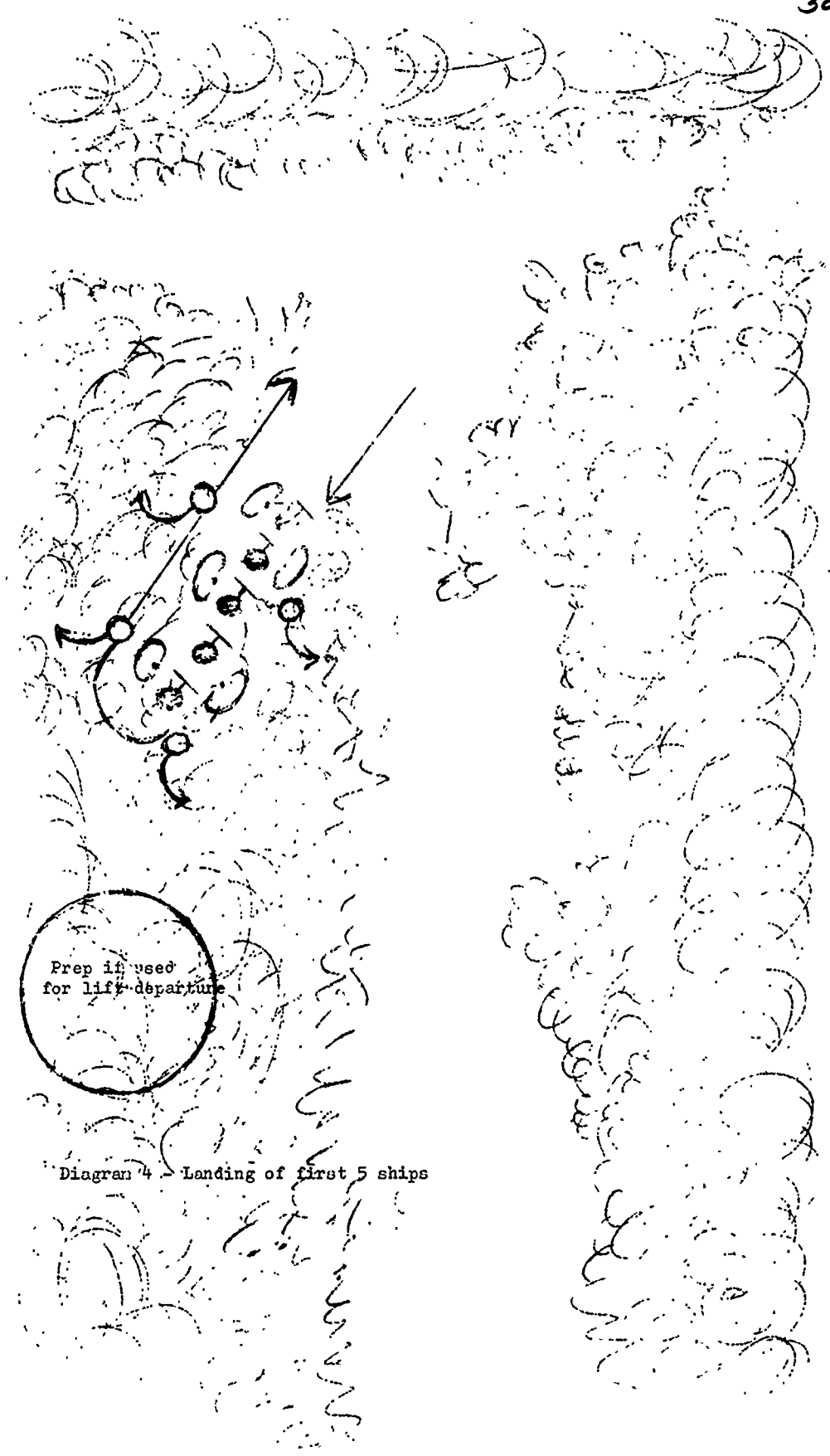
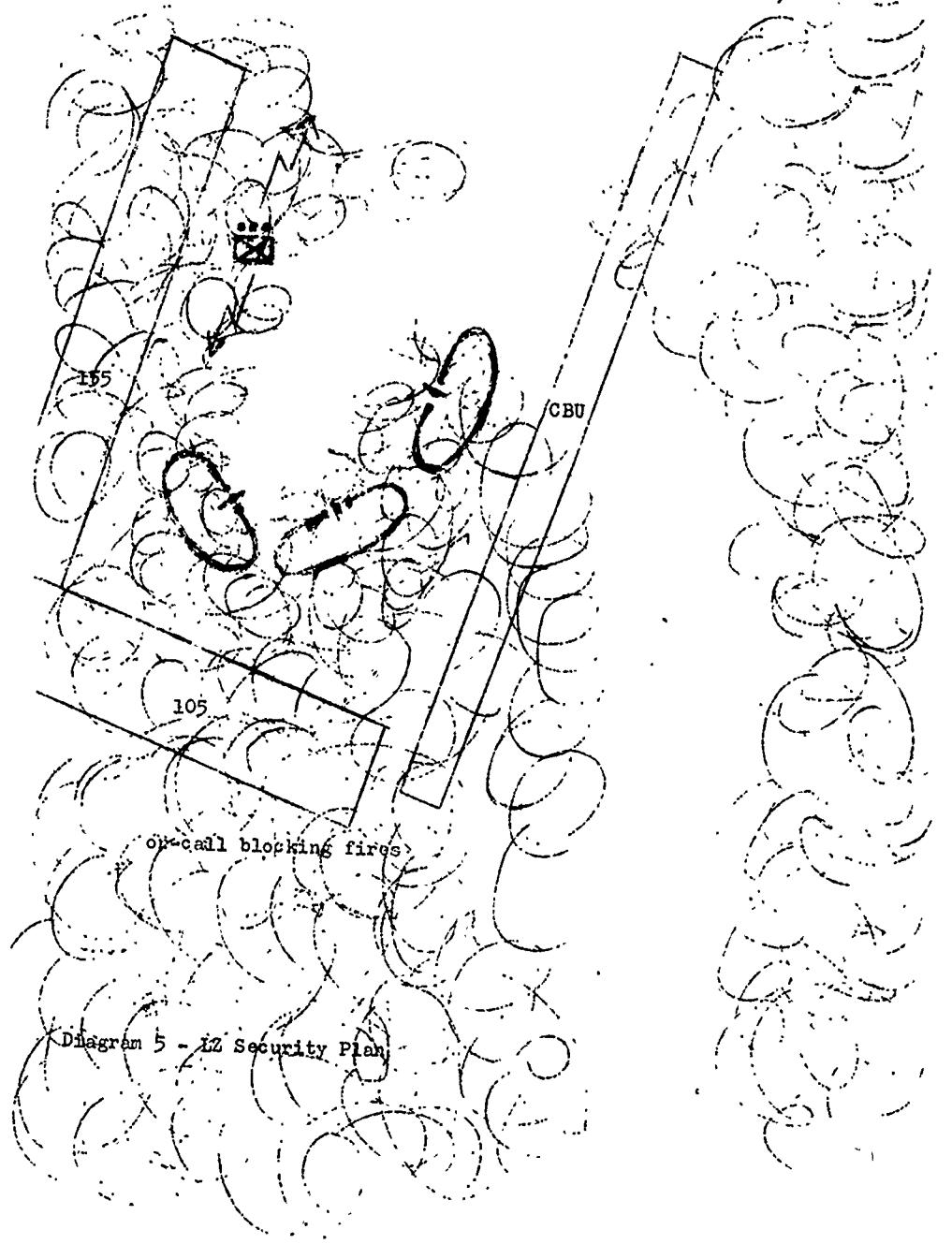

Diagram 4 - Landing of first 5 ships

31



CONFIDENTIAL

32

JUNGLE CLEARING

ITEM: Jungle Clearing

DISCUSSION: During Operation DALLAS the 2-2 Infantry (Mech) conducted jungle clearing operations in the VINH LOI Woods with tank dozers and Rome plows. When contact which indicated the presence of a base camp was made with VC/NVA elements during jungle clearing, the mechanized elements would develop the situation by deploying linearly, while directing supporting air and artillery fires into the suspected base camp. Upon clearing a circular swath around the base camp, additional swaths were progressively cleared into the center of the camp from the circle. This configuration of the cleared jungle took on the appearance of a spoked wheel superimposed on the base camp. After occupation and security of the base camp by mechanized elements, the camp would be systematically destroyed by dozers. This methodical technique of destroying base camps during a jungle clearing operation resulted in extremely few casualties.

OBSERVATION: The use of tank dozer/Rome plows in conjunction with mechanized forces in jungle clearing operations can effectively reduce US casualties while at the same time speed the clearing of the jungle.

FCL

ITEM: Fire Coordination Line (FCL)

DISCUSSION: During Operation MANHATTAN 1st Infantry Division forces were withdrawn behind a FCL 1,000 meters from the SAIGON River before the River Assault Group (RAG) force began its sweep. Additionally, a liaison officer from the division accompanied the RAG force to insure adequate fire control. This proved to be successful.

OBSERVATION: In an operation along a major water route where blocking forces are employed on both sides of the river and a RAG force sweeps the water route between the blocking forces, it is vital to establish a FCL for both blocking forces to prevent friendly forces from becoming inadvertently engaged with the RAG force.

B. RECOMMENDATIONS: None.

FOR THE COMMANDER:

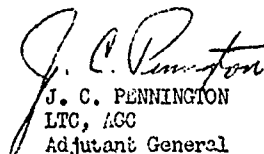
J. C. PENNINGTON
LTC, AGC
Adjutant General

DISTRIBUTION:
Special

CONFIDENTIAL

33

AVFBC-H 1st Ind
SUBJECT: Operational Report - Lessons Learned, 1st Infantry Division,
31 July 1967 (RCS CSFOR-65) (U)

DA, HQ II FFORCEV, APO San Francisco 96266 15 Sep 1967

THRU: Commanding General, USARV, ATTN: AVHGC-DH, APO 96375

Commander in Chief, US Army Pacific, ATTN: GPOP-MH, APO 96558

TO: Assistant Chief of Staff for Force Development, Dept of the Army,
Washington, D.C. 20310

1. Subject report is forwarded.
2. This headquarters has reviewed report and concurs.

FOR THE COMMANDER:

t/R. E. WAMBSGANSS
CPT, AGC
Asst AG

AVHGC-DST (25 Aug 67) 2d Ind
SUBJECT: Operational Report-Lessons Learned for the Period Ending
31 July 1967 (RCS CSFOR-65) (U)

HEADQUARTERS, UNITED STATES ARMY VIETNAM, APO San Francisco 96375 31 OCT 1967

TO: Commander in Chief, United States Army, Pacific, ATTN: GPOP-OT,
APO 96558

1. This headquarters has reviewed the Operational Report-Lessons Learned for the period ending 31 July 1967 from Headquarters, 1st Infantry Division (WAHD) as indorsed.

2. Pertinent comments follow: Reference item concerning physical profiles, paragraph A, Commander's Observation, page 18: Concur.

a. The problem of personnel possessing combat arms MOS's arriving in RVN who are not physically qualified for assignment is no greater in the 1st Infantry Division than other commands. Because of the number of profiled personnel arriving, they are assigned to units in RVN regardless of profile serial. Upon determination by unit commander that no position exists in which the individual can be utilized, reassignment instructions are immediately furnished by this headquarters.

b. Recommend that Department of the Army place greater emphasis on proper classification and reclassification action for personnel with assignment limitations caused by physical profiles. It is imperative that proper reclassification action be taken by CONUS and overseas commanders UP paragraph 2-30a (2), AR 600-200, for personnel volunteering or levied for RVN, prior to departure for this command.

3. Unit will be notified of actions and comments by routine indorsement which returns this report.

FOR THE COMMANDER:

C. S. Nakatsukasa
C. S. NAKATSUKASA
Captain, AGC
Assistant Adjutant General

35-

GPOP-DT(25 Aug 67) 3d Ind (U)
SUBJECT: Operational Report for the Quarterly Period Ending 31 July 1967
from HQ, 1st Inf Div (UIC: WAHDAA) (RCS CSFOR-65) (U)

HQ, US ARMY, PACIFIC, APO San Francisco 96558

4 JAN 1968

TO: Assistant Chief of Staff for Force Development, Department of the
Army, Washington, D. C. 20310

This headquarters has evaluated subject report and forwarding
indorsements and concurs in the report as indorsed.

FOR THE COMMANDER IN CHIEF:



K. F. OSBOURNE
MAJ, AGC
Asst AG

1 Incl .
nc

31
CONFIDENTIALDEPARTMENT OF THE ARMY
HEADQUARTERS 2D BRIGADE 1ST INFANTRY DIVISION
AIO San Francisco 96345

AVDB-AMT

6 August 1967

SUBJECT: Operational Report on Lessons Learned (RCS CGG FO-25) (RI) (U)

TO: Commanding General
1st Infantry Division
ATTN: AVDB-T
AIO 96345

1. (C) Part I. INTRODUCTION:

a. Background: During the preceding period (1 May 67 - 31 July 67), 2d Brigade participated in one division size operation and one continuous brigade operation. The Division operation in which the Brigade was committed was Op DALLAS (17 May 67 - 25 May 67). In Op LAM SON 67, 2d Brigade worked in close cooperation and coordination with 5th ARVN Division and BINH DUONG Sector, 18th ARVN Division and LIEN HOA Sector, CAPITAL MILITARY DISTRICT and GIA DINH Sector. LAM SON 67 operations included: jungle clearing operations, search and destroy operations, cordon and search operations, platoon and squad size ambushes and saturation patrolling, security missions of Engr units, forward support areas, roads and designated village chief; convoy escort and road clearing; revolutionary development projects, civic action programs, population control activities and psychological operations; visual reconnaissance flights and the direction of airstrikes and artillery concentrations. During the reporting period, at varying times, the following battalions participated in 2d Brigade operations: 1/18 Inf, 2/18 Inf, 2/16 Inf, 2/2 Inf (Mech) 2/28 Inf, 1/26 Inf, 1/16 Inf. The 1/4 Cav, B/2/34 Arm, A/5/2 Arty, 1st Engr, 168 Engr and 1/11 ACR also participated in brigade operations. The 1/7 Art~~y~~ was in direct support of the Brigade throughout the reporting period.

b. Brigade Organization: (Units and Commanding Officers).

(1) 2d Brigade, 1st Infantry Division:

(a) LTC Alexander M. Haig: 1 May - 29 May 67.

(b) COL Charles E. Thebaud: 30 May - 31 Jul 67.

(2) 1st Battalion, 18th Infantry:

(a) LTC Richard E. Cavezos: 1 May - 31 Jul 67.

(3) 2d Battalion, 18th Infantry:

(a) LTC Lewis R. Baumann: 1 May - 17 May 67.

(b) LTC James F. Irice: 18 May - 31 July 67.

(4) 2d Battalion, 16th Infantry:

(a) LTC Joseph R. Ulatoski: 1 May - 9 Jul 67.

(b) LTC Stanley J. Farmentier: 10 Jul - 31 Jul 67.

(5) 2d Battalion, 2d Infantry:

(a) LTC Edward J. Collins: 1 May - 29 May 67.

(b) LTC John D. Felton: 30 May - 31 Jul 67.

32
CONFIDENTIAL

CONFIDENTIAL

- (6) 2d Battalion, 28th Infantry:
 - (a) LTC Jerry S. Edwards: 1 May - 26 June.
 - (b) LTC Edward J. Cavanaugh: 27 Jun - 31 Jul 67.
- (7) 1st Battalion, 26th Infantry:
 - (a) LTC Joseph H. Hoffman: 1 May - 31 Jul 67.
- (8) 1st Battalion, 16th Infantry:
 - (a) LTC Rufus C. Lazzell: 1 May - 28 Jun 67.
 - (b) LTC Calvert T. Benedict: 29 June - 31 Jul 67.
- (9) 1st Squadron, 4th Cavalry:
 - (a) LTC Thomas W. Fife: 1 May - 1 Jun 67.
 - (b) LTC John W. Seigle: 2 Jun - 31 Jul 67.
- (10) Headquarters Company, 2d Brigade:
 - (a) CPT Gerald E. Tilleux: 1 May - 31 Jul 67.
- (11) 1st Battalion, 7th Artillery:
 - (a) LTC George L. McFadden: 1 May - 21 May 67.
 - (b) LTC John W. Cassell: 5 Jun - 31 Jul 67.
- (12) Co B, 1st Engineer Battalion:
 - (a) CPT Robert C. Lee: 1 May - 3 Jul 67.
 - (b) CPT Marion L. Caldwell: 4 Jul - 31 Jul 67.
- (13) Co A, 168th Engineer Battalion:
 - (a) CPT Donnell D. Whitley: 1 May - 20 Jul 67.
 - (b) 1LT Douglas E. Holen: 21 Jul - 31 Jul 67.
- (14) Co E, 701st Maintenance:
 - (a) CPT Michael F. Gandee: 1 May - 31 Jul 67.
- (15) Co C, 1st Medical Battalion:
 - (a) CPT Robert L. Moesinger: 1 May - 31 Jul 67.

2. (C) Part II. TACTICAL OPERATIONS:

a. During the reporting period the Brigade participated in one Division operation, Op DALLAS and conducted one Brigade operation, the continuous Op LAM SON 67.

b. Chronology of Tactical Operations:

- (1) Operation LAM SON 67: 1 May - 31 Jul 67.

Continuing Op LAM SON 67, 2d Brigade in conjunction with 5th ARVN Division and BINH DUONG Sector, 18th ARVN Div and BIEN HOA Sector and Capital Military District and GIA DINH Sector conducted tactical operations in designated areas to locate and destroy VC/NVA main force units, guerrilla units,

CONFIDENTIAL

and VC infrastructure, continued, by constant application of combat fire power, to cause individual members of these VC organizations to rally to GVN control in order to stimulate further Revolutionary Development Activities in these areas. Op LAM SON continued to place emphasis on strengthening local defenses (insuring a secure environment) and extending developmental projects. In the LAM SON 67 tactical area of operations; the 2d Brigade conducted jungle clearing operations, search and destroy operations, cordon and search operations, platoon and squad size ambushes and saturation patrolling; provided security at Rock Quarry and laterite pits, for Village Chief of TAN PHUOC KHANH and engineer work parties; secured and cleared roads and forward support areas; provided convoy escort; conducted numerous civil affairs activities to include Hamlet Festivals, population control activities, MEDCAIs, DENTCAIs, food distribution and solatium payments (resulting from property damage or personal injury), and various other revolutionary development projects and civic action programs; conducted extensive ground and air psychological operations; directed airstrikes and conducted artillery concentrations on VC base camps, supply areas, suspected VC locations and ADF targets; conducted Eagle Flights and Starlight missions, and provided basic and unit training for Regional Force Company 969. Cordon and search ops with hamlet festivals were conducted in TAN HUEI (XT910106) on 8 May 67, HOA NHUT (XT883177) on 17 Jun 67, BINH CHUAN (XT886164) on 30 Jun 67, THUAN GIAO (XT873122) on 9 Jul 67, and TAN BA (XT934137) on 18 Jul 67. A cordon and search operation with population control activities was conducted in VINH TRUONG (XT868175) on 12 Jul 67. Cordon and search (only) operations were conducted in DONG TAM (XT935052) 25-26 Jul 67, AT TAN NA (XT955075) on 14 Jul 67, BINH TRI (XT925087) on 15 Jul 67, NEW BUNG DIA (XT887216) on 17 Jul 67, HOA LOI II (XT816238) on 21 Jul 67, at THU CHANH (XT858234) on 27 Jul 67 and at THU CHANH again on 29 Jul 67. A feint seal was conducted at THU HUU (XT854143) on 11 Jul 67. All LAM SON 67 operations were accomplished in close cooperation and coordination with elements of 5th ARVN Division and BINH DUONG Sector, 18th ARVN Division and BIEN HOA Sector, and Capital Military District and GIA DINH Sector respectively. In addition, Joint Committees of the "County Team" (composed of representatives of the Provincial Office of Civilian Operations, BINH DUONG Sector, 5th ARVN Division and 2d Brigade) were established and during this reporting period continued coordinating, planning, establishing priorities and making recommendations concerning Revolutionary Development activities. LAM SON 67 continued to improve the secure environment in the vital central BINH DUONG Province between the SAIGON and DONG NAI Rivers. LAM SON 67 continues. Results from Operation LAM SON 67 from 1 May 67 to 31 Jul 67 were as follows: 58 VC KIA, 3 VC KIA (rob), 30 FW, 1 VCC, 5 deserter, 72 draft evaders, 285 detainees, 2 boxes VC propaganda leaflets, 4 firing pens, 95m trench, 34 ponchos, 1 steel pot, 4 canteens, sml quan medical supplies, 2 entrenching tools, 1 booby-trapped 155mm rd, 14 M16 magazines, 1 jar pellets, 1 bomb, 2 shelves, 61 CBU, 13-7.62 rds, 8 motorcycles, 1 canteen cover, 40 transistor batteries, 4 shirts, 4 booby-trapped butterfly bombs, 6 VC gas masks, 2 benches, 9 wells, 1 spider hole, 1 M79 wpn, 6 sleeping positions, 3-.45 cal pistols, 1 Smith & Wesson revolver, 6 batteries, 6 booby-trapped CBU's, 1 pr shorts, 2 bloody shirts, 2 shelters with roofs, 4 rooms, 4 M1 rifles, 1 Springfield bolt-action rifle, 2 CHICOM carbines, 100 lbs beans, 2 AK 47's, 10 knives, 1 CHICOM pistol, 18 bolts cloth, 1 M72 LAW, 3296 rds SA ammo, 1-60m mortar base plate, 2 carbine stocks, 3-105mm fuses, 2-60mm mortars rds, 1 roll concertina, 1 homemade bomb, 2 blasting caps, 2 torpedos, 24 AF mines, 350 lb peanuts, 50 lb milk, 50 lb sardines, 10 lb tobacco paper, 8 lean to's, 2 buckets, 10 booby-trapped grenades, 11 spider holes, 29 fighting positions, 128 tunnels, 21 punji pits, 1 container, 122 foxholes, 4 booby-trapped 105mm rds, 20 US grenades, 5 claymore stand, 2 cots, 3-81mm duds, 4 pressure type detonators, 1-175mm dud, 3 claymore detonators, 14 bicycles, 2 Russian AT mines, 1 first aid kit, 1 mortar position, 26-155mm duds, 14 buffalos, 1 tent, 2-155mm booby-trap, 21 M79 rds, 2.8 tons rice, 1 Russian rifle, 72 rds 5.56, pots and pans, 4 large buildings, 1 pr shower shoes, 4 sleeping mats, 3 machetes, 2 shape charges, 2 blocks TNT, 10 lbs shrimp, 1-2.75mm rocket, 200 lbs noodles, 4 benches, 3 fishing poles, 1 Russian flag, 355 lbs salt, 8 gal nuoc nam, 75 lbs documents, 100 lbs soap, 2 typewriters, 10 SMG mag, 6 carbine mag, 15 lbs cake and nut roll, 7 ammo belts, 7 dummy mines, 1 sewing machine, 5 US helmet liners, 1 VC flag, 425 lbs brown sugar candy, 10 1/2 gal kerosene, 25 lbs flour, 8 cartons cigarettes, 2 flashlights, 2 lanterns, 5 gal cooking oil, 2 sleeping areas, sml quan clothing, 379 bunkers, 94 hutches, 42 base camps, 1 set fatigues, 1 butterfly bomb, 1 canteen cup, 3 US pistol belts, 62 CHICOM grenades, 2 helmet liners, 1-5 gal

CONFIDENTIAL

40

CONFIDENTIAL

can, 12 VC ponchos, 6-8" rds, 4 rifle grenades, 1 bow, 30 bowls, 3 pair pajamas, 56-105mm duds, 5-.30 cal rds, 7 tables, 1 latrine, 2 RFG rds, 1 anti-tank mine, 2 M16 rifles, 6 US claymores, 220' wire, 12 claymores, 2 US carbine, 1 bandoleer, 1-500 lb bomb, 1 helmet (US), 2 packs typing paper, 4 back packs, 1 walkie-talkie, 15 tooth brushes, 77 quarts vinegar, 2 axes, 600 lbs cement, 1 hoe, 2 picks, 1 watch, 1 clock, 1 deck of cards, 20 lbs tobacco, 12 cans beef, 14 pr sandals, 7-4.5 volt batteries, 6 flashlights, 3-55 gal drums, 120 lbs clothes, 1 gas stove, 1 mosquito net, .30 cal ammo, IRC-25 headset, 1 fin assy, rice bowls.

(2) Operation DALLAS (17 - 25 May 67).

Operation DALLAS was a Division size operation which missioned the 2d Brigade to conduct search and destroy operations in the ONG DONG Jungle and to control convoys between TAN UYEN and DI AN from 17 - 25 May 67. The 2d Brigade participation in Op DALLAS was conducted in three phases. On 17 May, 2d Bde initiated Phase I with search and destroy operations in AC DARING with 2/2 Inf Mech and commenced escorting convoys from DI AN to TAN UYEN. In Phase II and III, 2d Brigade with 2/2 Inf (-) (Mech), 2 Flats B/2/34 Arm, 1/11 ACR (-) and A/2/18 Inf conducted search and destroy operations and jungle clearing operations in the ONG DONG Jungle. Brigade terminated participation in Op DALLAS at 250600H May 67. Results of Operation were: 1 VC KIA (BC), 1 French bolt action rifle, 1 carbine, 1 Remington bolt action rifle, 6 VC base camps, 51 foxholes, 89 bunkers, 245 meters trench, 4 punji pits, 21 underground rooms, 1 ton polished rice, 41 booby trapped grenades, 1-90mm rd, 12-105mm rds, 3-175mm rds, 4-8" rds, 43 CBU's, 2 CHICOM grenades, 4-60mm rds, 2-81mm rds, 1 rifle grenade, 2 VC flags, 1 Russian flag, 1 stove, 11 US cots, 1 VC gas mask, 1 pair binoculars, 2 cooking pots, 2 canteens, 2 mosquito nets, 3-5 gal water cans, small amount documents and medical supplies.

3. (C) Part III: INTELLIGENCE:

a. May 1967: There were 47 VC initiated incidents during the month of May. 15 involved detonation of pressure type mines by vehicles. The majority of these were during jungle clearing operations. Snipers were active along routes of movement and in areas where jungle clearing operations were being conducted. There were 27 of these incidents, 2 B40 rounds were fired at a tank and a Rome Flow vicinity of XT918103 on 10 May 67. There were no significant trends during this period as guerrilla forces continued harassing and delaying activities while local force companies avoided contact. VC control of areas not occupied by GVN/US forces remain unchanged.

b. June 1967: There were 17 VC initiated incidents during the month of June. 5 were detonations of booby traps by tracked vehicles during jungle clearing operations, 5 were incidents of sniper fire, 5 incidents were of hand grenades thrown at ambush positions and vehicles and 2 were mortar attacks with 60mm and 81mm mortars. There was a lessening of sniper incidents directed against convoys during this month. Guerrilla activity in general was at a low ebb and local force companies avoided contact. There were 5 terrorist incidents directed against civilians. The VC continue to be vulnerable to the psychological operations. The VC will increase terrorist activities to counteract the success of the RD program being carried out in the BIEN HOA and BINH DUONG Provinces. The VC infrastructure within the village of FHU CHANH, CHAU THANH District was severely damaged, if not destroyed, due to operations conducted there during the month of June.

c. July 1967: There were 65 VC initiated incidents during the month of July. Of these, 24 were detonations of mines or booby traps during jungle clearing operations; 35 incidents were SA and AW fire directed at ambush positions, perimeter defenses and vehicles; 3 incidents were terrorist acts against civilians; and 3 incidents were mortar and rocket attacks. In general, VC activity in the LAM SON AO was on the upswing during July. The VC continue to be vulnerable to the psychological operations. It is probable that terrorist activities will increase as the SVN elections draw near. Also, the VC will continue terrorist activities to counteract the success of the RD program being carried out in BIEN HOA and BINH DUONG Provinces. The VC infrastructure of HOA LOI II was severely damaged due to the operation conducted there on 21

4

CONFIDENTIAL 35

41

CONFIDENTIAL

Jul 67. The mortar and rocket attacks on FHU LOI and FHUOC VINH on 29 July were carried out by the U80 VC Arty Regt at coordinates XT8424. A member of the unit, captured by D/1/4 Cav on 29 Jul, stated that there were approximately 400 men in his unit and approximately 80 of these were NVN.

4. (C) Part IV: PERSONNEL:

a. Present Strength: The assigned strength of the Brigade at the beginning of the reporting period was 122 Officers, 9 Warrant Officers, and 2282 Enlisted Men. The strength of the Brigade at the end of the reporting period was 119 Officers, 7 Warrant Officers, and 2536 Enlisted Men.

b. Replacements: The Brigade received 924 personnel replacements and lost 675 personnel during the reporting period, resulting in a net gain of 249 Personnel.

c. Military Discipline: Military Discipline has been excellent. There were no unusual problems concerning law and order.

d. Burials: All grave registration activity is handled by the Forward Support Section, 1st Supply and Transportation Battalion and also the 506th Quartermaster Company. All deceased have been evacuated through channels with no burials in the field.

e. Civilian Employees: At the present, the Brigade hires 112 unskilled laborers for each day, under the temporary hire program, for tasks such as clearing fields of fire, filling sand bags, drainage ditches, and leveling ground for foundation pads. 200 local Nationals are employed under the permanent hire program for jobs as KP's, waitresses, carpenter, automotive mechanics, gardeners, and janitors.

f. Morale and Personnel Services: Morale of this Brigade continues to be excellent. The brigade is receiving adequate quotas for out of country R&R. Red Cross support for personal problems has been timely and excellent. This Brigade has processed 736 awards during the reporting period.

g. Civil Assistance: Relations with the civilian communities within the Brigade TAOR have continued to be excellent. Close coordination with US/GVN officials at district and province levels has resulted in regular Medical Civic Action Programs, insuring that all major villages/hamlets receive maximum benefits from US/VN medical assistance teams. During the reporting period some 8,665 persons were treated. Civic Action projects were coordinated with district/province officials to insure that only GVN-approved projects were undertaken. US assistance to ARVN/RF/IF units continued to include aid in the construction of outposts and bunkers; provision of barrier materials; maintenance contact teams for repair of weapons, vehicles, and signal items, and MEDCAs for military dependents.

5. (C) Part V: LOGISTICS:

a. May 1967: During the reporting period logistical transport was provided on Op LAM SON by both helicopter and land transport. An MSR was opened daily and secured. 701st Maintenance Battalion assumed support maintenance responsibility for the two platoons from B Co, 2/34 Armor. A contact team from B Co, 701st Maintenance Battalion was maintained at FHU LOI to provide assistance to the 2/2 Inf (Vech) while engaged on Op LAM SON. When armor is working with infantry, an M88 is required for maintenance in the field. The M88 Tank Recovery Vehicle belonging to A Co, 701st Maintenance Battalion operates under an area support basis, however it was released to the 2/2 Inf for field support. Until such time as an M88 becomes readily available in the field, to the unit having the armor, the lack of a VTR will continue to be a problem. Log bases were located at DI AN, FHU LOI and for 2/2 delivered Class III, LAI KHE. The health of the command and physical of the troops remained good.

b. June 1967: During the reporting period logistical transport was provided on Operation LAM SON by both helicopter and land transport. An MSP

5
CONFIDENTIAL

36

CONFIDENTIAL

was opened and secured daily. 701st Maintenance Battalion continued to provide support maintenance for the divisional units operating with the 2d Brigade, as well as the 2 platoons from the 2/34th Armor while on Operation LAM SON 67. The 701st Maintenance Battalion provided a Contact Team at FHU LOI for support of the 2/2 Inf (Mech) and other units operating from that location. The Contact Team returned on 28 June 1967. Log bases were located at FHU LOI and DI AN, and for aerial delivery of IOL, LAI KHE. In one instance a unit operating for one day with the 2d Brigade, the 2/28 Inf, maintained its log base at LAI KHE. The health of the command and physical condition of the troops remained good.

c. July 1967: During the reporting period logistical transport was provided by both helicopter and vehicular means. Vehicular transport requirements have grown appreciably; however, to date requirements have been met through local resources and divisional assets. B Co, 701st Maintenance Battalion has continued to provide support maintenance for the units operation with the 2d Brigade. In the case of the 1st Squadron 4th Cavalry the permanent contact team at FHU LOI has continued to render them support. Also B Co, 701st Maint, coupled with the 701st Contact Team at FHU LOI, was responsible for relieving the critical truck problem of the 1st Squadron 4th Cavalry by replacing engines in the 5-ton vehicles of the 1st Squadron 4th Cavalry. The 2/2 Inf (Mech) experienced some difficulty in recovery operations due to the absence of a M88 track recovery vehicle. This problem, to an extent was alleviated by the arrival of the M88 belonging to B Co 2/34th Armor. On 28 July 1967, another M88 from 2/34th arrived to supplement it. During the interim the void was covered by an M88 from 1st Squadron 4th Cavalry and later by one from HC & A Co, 701st Maintenance. Delivery of IOL and Class V to 2/2 Inf has been accomplished primarily by aerial means. The IOL is rigged at and flown from LAI KHE. Log bases have been maintained at DI AN and FHU LOI, Classes I thru IV being available at these locations, with II & IV in limited quantities at FHU LOI. Class V has been obtained from the LONG BINH ASI.

6. (C) Part VI: CHRONOLOGY:

1 May: 2d Bde continued Op LAM SON 67. 2/16 Inf remained attached 3d Bde. 1/18 Inf remained attached 1st Bde. 2/18 Inf remained attached 3d Bde. 1/26 Inf with one section of 4/5/2 Arty continued Op LAM SON 67 securing engineer effort along Rte ORANGE, bridge site and laterite pit, securing the Village Chief of TAN THUOC KHANH and the Frenchman's Flat Rock Quarry. 2/2 Mech (-) conducted show of force in the CO MI Jungle vic XT8812, FHU LOI Plains vic XT8620 and S&D operations west of HOA LOI II vic XT7924. 1/28 Inf stood down for maintenance at FHU LOI and was Bde RRF. D/1/4 Cav conducted VR's and eagle flights in the LAM SON 67 AO. 1/7 Arty continued in DS of 2d Bde.

2 May: 2d Bde continued Op LAM SON 67. 2/16 Inf remained attached 3d Bde. 1/18 Inf remained attached 1st Bde. 2/18 Inf remained attached 3d Bde. 1/26 Inf with one section of 4/5/2 Arty continued Op LAM SON 67 clearing road along Rte BRONZE. 2/2 Mech (-) with B/1/4 Cav (-) and 4/2/34 Arm continued Op LAM SON 67 conducting S&D ops vic XT8920, XT8721 and XT8722. 1/28 Inf remained Bde RRF at FHU LOI until 0700H and moved to relieve 1/26 Inf in place on Rte BRONZE to assume mission of securing engineer effort along Rte BRONZE, bridge site and laterite pit, securing the village chief of TAN THUOC KHANH and the engineer rock quarry (XT910160). D/1/4 Cav conducted VRs and "Eagle Flights" in LAM SON 67 AO. 1/7 Arty remained in DS of 2d Bde.

3 May: 2d Bde continued Op LAM SON 67. 2/16 Inf remained attached 3d Bde. 1/18 Inf remained attached 1st Bde. 2/18 Inf remained attached 3d Bde. 1/26 Inf conducted airborne assault into AO ORANGE and conducted S&D operations. 2/2 Mech (-) with B/1/4 Cav (-) and 4/2/34 Arm continued Op LAM SON 67 conducting S&D ops vic XT8820, XT8821 and XT8822. 1/28 Inf cleared and secured Rte BRONZE in sector and continued security missions at Frenchman's Flat rock quarry, laterite pit, bridge site, and Village Chief of TAN THUOC KHANH. D/1/4 Cav conducted VR's and "Eagle Flights" in LAM SON 67 AO. 1/7 Arty remained in DS of 2d Bde.

4 May: 2d Bde continued Op LAM SON 67. 2/16 Inf remained attached 3d Bde. 1/18 Inf remained attached 1st Bde. 2/18 Inf remained attached 3d Bde. 1/26 Inf continued Op LAM SON 67 conducting S&D ops vic XT8627. 1/28 Inf continued Op LAM SON 67 with no change in assigned mission. 2/2 Mech (-) stood down for maintenance at FHU LOI. 1/7 Arty remained in DS of 2d Bde.

37 CONFIDENTIAL

43

CONFIDENTIAL

5 May: 2d Bde continued Op LAM SON 67. 2/16 Inf remained attached 3d Bde. 1/18 Inf remained attached 1st Bde. 2/18 Inf remained attached 3d Bde. 1/26 Inf continued Op LAM SON 67 conducting S&D ops vic XT8627. 1/28 Inf continued Op LAM SON 67 with no change in assigned mission. 2/2 Mech (-) stood down for maintenance at FHU LOI. 1/7 Arty remained in DS of 2d Bde.

6 May: 2d Bde continued Op LAM SON 67. 2/16 Inf remained attached 3d Bde. 1/18 Inf remained attached 1st Bde. 2/18 Inf remained attached 3d Bde. 1/26 Inf continued Op LAM SON 67 conducting S&D ops in zone. 1/28 Inf continued Op LAM SON 67 securing engr work parties at laterite pit and Frenchman's Flat Rock Quarry, cleared and outposted Rte BRONZE by 0637H, continued to provide security for Village Chief of TAN PHUOC KHANH, and conducted local combat patrols. 2/2 Mech (-) stood down for maintenance at FHU LOI. 1/7 Arty continued in DS of 2d Bde.

7 May: 2d Bde continued Op LAM SON 67. 2/16 Inf remained attached 3d Bde. 2/18 Inf remained attached 3d Bde. 1/26 Inf continued Op LAM SON 67 conducting S&D ops in zone. 1/28 Inf continued Op LAM SON 67 securing engr work parties at laterite pit and Frenchman's Flat Rock Quarry, cleared and outposted Rte BRONZE by 0837H, continued to provide security for Village Chief of TAN PHUOC KHANH, and conducted local combat patrols. 2/2 Mech (-) stood down for maintenance at FHU LOI. 1/7 Arty remained in DS of 2d Bde.

8 May: 2d Bde continued Op LAM SON 67. 2/16 Inf remained attached 3d Bde. 1/18 Inf remained attached 1st Bde. 2/18 Inf remained attached 3d Bde. 1/26 Inf continued Op LAM SON 67 conducting S&D ops in zone. 1/28 Inf continued Op LAM SON 67 securing Engr work parties at laterite pit and Frenchman's Flat Rock Quarry and continued to provide security for Village Chief of TAN PHUOC KHANH. 2/2 Mech (-): One company opened and secured Rte BRONZE and Dn (-) occupied assigned sector at TAN HIEF seal. 1/7 Arty (-) remained in DS of 2d Bde.

9 May: 2d Bde continued Op LAM SON 67. 2/16 Inf remained attached 3d Bde. 1/18 Inf remained attached 1st Bde. 2/18 Inf remained attached 3d Bde. 1/26 Inf continued Op LAM SON 67 conducting S&D ops in zone. 1/28 Inf continued Op LAM SON 67 securing Engr work parties at laterite pit and Frenchman's Flat Rock Quarry, road clearing ops along Rte BRONZE and continued to provide security for Village Chief of TAN PHUOC KHANH. 2/2 Mech (-) continued Op LAM SON 67 conducting S&D operations and securing Rome Flows in TAN HIEF Woods. 1/7 Arty (-) remained in DS of 2d Bde.

10 May: 2d Bde continued Op LAM SON 67. 2/16 Inf remained attached 3d Bde. 1/18 Inf remained attached 1st Bde. 2/18 Inf moved from LAI KHE to DI AN and became OICON 2d Bde. 1/26 Inf continued Op LAM SON 67 conducting S&D ops in zone. 1/28 Inf continued Op LAM SON 67 securing Rome Flow operations. Engr work parties at laterite pit and Frenchman's Flat Rock Quarry, road clearing ops along Rte BRONZE and continued to provide security for Village Chief of TAN PHUOC KHANH. 2/2 Mech (-) moved from FHU LOI to LAI KHE commencing at 0730H. 1/7 Arty remained in DS of 2d Bde.

11 May: 2d Bde continued Op LAM SON 67. 2/16 Inf remained attached 3d Bde. 1/18 Inf remained attached 1st Bde. 2/18 Inf continued to stand down at DI AN. 1/26 Inf was airlifted from FHU LOI to LAI KHE. 1/28 Inf continued Op LAM SON 67 securing Rome Flow operations, Engr work parties at laterite pit and Frenchman's Flat Rock Quarry, road clearing ops along Rte BRONZE and continued to provide security for Village Chief of TAN PHUOC KHANH. 1/7 Arty remained in DS of 2d Bde.

12 May: 2d Bde continued Op LAM SON 67. 2/16 Inf remained attached 3d Bde. 1/18 Inf remained attached 1st Bde. 2/18 Inf continued Op LAM SON 67 conducting S&D in HUNG DINH Jungle without incident. 1/28 Inf continued Op LAM SON 67 securing Rome Flow operations, Engr work parties at laterite pit and Frenchman's Flat Rock Quarry, and clearing ops along Rte BRONZE and continued to provide security for Village Chief of TAN PHUOC KHANH. 1/7 Arty remained in DS of 2d Bde.

13 May: 2d Bde continued Op LAM SON 67. 2/16 Inf remained attached 3d Bde. 2/18 Inf with B/2/34 Arty (-) continued Op LAM SON 67 conducting S&D in HUNG DINH Jungle. 1/28 Inf continued Op LAM SON 67 securing Rome Flow operations, Engr work parties at laterite pit and Frenchman's Flat Rock Quarry, clearing ops along Rte BRONZE and continued to provide security for

CONFIDENTIAL

44

Village Chief of TAN THUOC KHANH. 1/7 Arty remained in DS of 2d Bde.

14 May: 2d Bde continued Op LAM SON 67. 2/16 Inf remained attached 3d Bde. 1/18 Inf remained attached 1st Bde. 2/18 Inf with B/2/34 Arm (-) continued Op LAM SON 67 conducting S&D ops in HUNG DINH Jungle vic XT8810. 1/28 Inf with B/1/4 Cav (-) continued Op LAM SON 67 securing Rome Flow ops, Engr work parties at laterite pit and Frenchman's Flat Rock Quarry, clearing ops along Rte BRONZE and continued to provide security for Village Chief of TAN THUOC KHANH. D/1/4 Cav continued to secure TAN UYEN. 1/7 Arty remained in DS of 2d Bde.

15 May: 2d Bde continued Op LAM SON 67. 2/16 Inf remained attached 3d Bde. 1/18 Inf remained attached 1st Bde. 2/18 Inf with B/2/34 Arm (-) continued Op LAM SON 67 conducting S&D ops in HUNG DINH Jungle and closed in to DI AN at 1339H after terminating ops. 1/28 Inf continued Op LAM SON 67 securing Rome Flow ops, Engr work parties at laterite pit and Frenchman's Flat Rock Quarry, clearing ops along Rte BRONZE and continued to provide security for Village Chief of TAN THUOC KHANH. 2/2 Mech (-) Bn became OICON 2d Bde upon closing THU LOI. 1/7 Arty (-) remained in DS of 2d Bde.

16 May: 2d Bde continued Op LAM SON 67. 2/16 Inf remained attached 3d Bde. 1/18 Inf remained attached 1st Bde. 2/18 Inf continued Op LAM SON 67 securing Rome Flow ops, Engr work parties at laterite pit and Frenchman's Flat Rock Quarry, clearing ops along Rte BRONZE and continued to provide security for Village Chief of TAN THUOC KHANH. 2/2 Mech (-) stood down at THU LOI. 1/7 Arty (-) remained in DS of 2d Bde.

17 May: 2d Bde continued Op LAM SON 67. 2/16 Inf remained attached 3d Bde. 1/18 Inf remained attached 1st Bde. 2/18 Inf (-) secured Rome Flows in the BINH TRI Woods vic XT9101 and conducted extensive night ambushes in BINH TRI Woods area. 1/28 Inf continued Op LAM SON 67 securing Rome Flow ops, Engr work parties at laterite pit and Frenchman's Flat Rock Quarry, continued to provide security for Village Chief of TAN THUOC KHANH, cleared and secured Rte BRONZE and Rte 13 to Hwy 314. 2/2 Mech (-) with B/2/34 Arm (-) and Co A 2/18 Inf moved to field locations and conducted S&D ops in ONG DONG Jungle. 1/7 Arty (-) remained in DS of 2d Bde.

18 May: 2d Bde continued Op LAM SON 67 and Op DALLAS. 2/16 Inf remained attached 3d Bde. 1/18 Inf remained attached 1st Bde. 2/18 Inf (-) continued to secure Rome Flows, conducted S&D ops in AO DARKNESS and conducted extensive night ambushes in AO. 1/28 Inf continued security of Rte BRONZE, Engr work parties at laterite pit and Frenchman's Flat Rock Quarry and Village Chief of TAN THUOC KHANH. 2/2 Mech (-) with B/2/34 Arm (-) and Co A 2/18 Inf conducted S&D ops in AO DARING. 1/7 Arty (-) remained in DS of 2d Bde.

19 May: 2d Bde continued Op LAM SON 67. 2/16 Inf remained attached 3d Bde. 1/18 Inf remained attached 1st Bde. 2/18 Inf continued Op LAM SON 67 with no change in assigned mission. 1/28 Inf continued Op LAM SON 67 securing Rte BRONZE, Engr work parties at laterite pit and Frenchman's Flat Rock Quarry, and the Village Chief of TAN THUOC KHANH. 2/2 Mech (-) with B/2/34 Arm (-) and Co A 2/18 Inf continued Op LAM SON 67 conducting S&D ops in ONG DONG Jungle. 1/7 Arty (-) remained in DS of 2d Bde.

20 May: 2d Bde continued Op LAM SON 67 and Op DALLAS. 2/16 Inf remained attached 3d Bde. 1/18 Inf remained attached 1st Bde. 2/18 Inf continued Op LAM SON 67 with no change in assigned mission. 1/28 Inf continued Op LAM SON 67 securing Rte BRONZE, Engr work parties at laterite pit and Frenchman's Flat Rock Quarry, and the Village Chief of TAN THUOC KHANH. 2/2 Mech (-) with B/2/34 Arm (-) and Co A 2/18 Inf continued Op LAM SON 67 conducting S&D ops in ONG DONG Jungle. 1/7 Arty (-) continued in DS of 2d Bde.

21 May: 2d Bde continued Op LAM SON 67 and Op DALLAS. 2/16 Inf remained attached 3d Bde. 1/18 Inf remained attached 1st Bde. 2/18 Inf (-) at DI AN and prepared for future operations. 1/28 Inf continued Op LAM SON 67 securing Rte BRONZE, Engr work parties at laterite pit and Frenchman's Flat Rock Quarry, and the Village Chief of TAN THUOC KHANH. 2/2 Mech (-) with B/2/34 Arm (-) and Co A 2/18 Inf continued Op DALLAS conducting S&D ops in ONG DONG Jungle. D/1/4 Cav (-) remained OICON 3d Brigade. 1/7 Arty (-) continued in DS of 2d Bde.

CONFIDENTIAL 39

CONFIDENTIAL

22 May: 2d Bde continued Op DALLAS and Op LAM SON 67. 2/16 Inf remained attached 3d Bde. 1/18 Inf remained attached 1st Bde. 2/18 Inf became OIFCON 1st Bde. 1/28 Inf continued Op LAM SON 67 securing Rte BRONZE, Engr work parties at laterite pit and Frenchman's Flat Rock Quarry, and the Village Chief of TAN THUOC KHANH. 2/2 Mech with B/2/34 Arm (-) continued Op DALLAS conducting S&D ops in ONG DONG Jungle. D/1/4 Cav remained OIFCON 3d Bde. 1/7 Arty remained in DS of 2d Bde.

23 May: 2d Bde continued Op DALLAS and Op LAM SON 67. 2/16 Inf remained OIFCON 3d Bde. 1/18 Inf airlifted to DI AN. 2/18 Inf remained OIFCON 1st Bde. 1/28 Inf continued Op LAM SON 67 securing Rte BRONZE, Engr work parties at laterite pit and Frenchman's Flat Rock Quarry, and the Village Chief of TAN THUOC KHANH. 2/2 Inf with B/2/34 Arm (-) continued Op DALLAS conducting security and recon patrols in ONG DONG Jungle. D/1/4 Cav remained OIFCON 3d Bde. 1/7 Arty (-) remained in DS of 2d Bde.

24 May: 2d Bde continued Ops DALLAS and LAM SON 67. 1/18 Inf conducted Op LAM SON 67 relieving 1/28 Inf of security missions on Rte BRONZE, Engr work parties at laterite pit and Frenchman's Flat Rock Quarry, and Village Chief of TAN THUOC KHANH. 2/18 Inf remained OIFCON 1st Bde. 2/16 Inf remained OIFCON 3d Bde. 1/28 Inf airlifted THU LOI to THUOC VINH. 2/2 Inf with B/2/34 Arm (-) continued Op DALLAS conducting S&D ops in AO DARING. D/1/4 Cav (-) remained OIFCON 3d Brigade. 1/7 Arty (-) remained in DS of 2d Bde.

25 May: 2d Bde continued Op LAM SON 67 and terminated Op DALLAS at 0600H. 1/18 Inf continued Op LAM SON conducting security missions on Rte BRONZE, Engr work parties at laterite pit and Frenchman's Flat Rock Quarry, and Village Chief of TAN THUOC KHANH. 2/18 Inf remained OIFCON 1st Bde. 2/16 Inf airlifted from THUOC VINH to BIEN HOA and moved from BIEN HOA to DI AN commencing 0905H. 2/2 Inf with B/2/34 Arm (-) continued Op DALLAS conducting S&D ops in AO DARING. D/1/4 Cav (-) remained Div Trps. 1/11 ACR (-) became OIFCON 2d Bde 0845H and conducted S&D in AO BENGAL without incident. 1/7 Arty (-) remained in DS of 2d Bde.

26 May: 2d Bde continued Op LAM SON 67. 1/18 Inf continued Op LAM SON 67 conducting security missions on Rte BRONZE, Engr work parties at laterite pit and Frenchman's Flat Rock Quarry, and Village Chief of TAN THUOC KHANH. 2/18 Inf remained OIFCON 1st Bde. 2/16 Inf stood down DI AN. 2/2 Inf with B/2/34 Arm (-) continued Op LAM SON 67 conducting S&D ops in AO DARING. D/1/4 Cav (-) remained Div Trps. 1/11 ACR (-) continued Op LAM SON 67 conducting S&D ops in AO BENGAL. 1/7 Arty (-) remained in DS of 2d Bde.

27 May: 2d Bde continued Op LAM SON 67. 1/18 Inf continued Op LAM SON 67 conducting security missions on Rte BRONZE, Engr work parties at laterite pit and Frenchman's Flat Rock Quarry, and Village Chief of TAN THUOC KHANH. 2/18 Inf remained OIFCON 1st Bde. 2/16 Inf relieved 1/18 Inf of security missions on Rte BRONZE, Engr work parties at laterite pit and Frenchman's Flat Rock Quarry, and Village Chief of TAN THUOC KHANH. 2/2 Inf with B/2/34 Arm (-) continued Op LAM SON 67 conducting S&D ops in AO DARING. D/1/4 Cav (-) remained Div Trps. 1/11 ACR (-) at 0625H, commenced move to XUAN LOC, released OIFCON 2d Bde. 1/7 Arty (-) remained in DS of 2d Bde.

28 May: 2d Bde continued Op LAM SON 67. 1/18 Inf airlifted DI AN to XT0723 commencing 1000H and became OIFCON 3d Bde. 2/18 Inf remained OIFCON 1st Bde. 2/16 Inf continued Op LAM SON 67 conducting security missions on Rte BRONZE, Engr work parties at laterite pit and Frenchman's Flat Rock Quarry, and Village Chief of TAN THUOC KHANH. 2/2 Inf with B/2/34 Arm (-) continued Op LAM SON 67 conducting S&D ops in AO DARING. D/1/4 Cav (-) remained Div Trps. 1/7 Arty (-) remained in DS of 2d Bde.

29 May: 2d Bde continued Op LAM SON 67. 1/18 Inf remained OIFCON 3d Bde. 2/18 Inf remained OIFCON 1st Bde. 2/16 Inf continued Op LAM SON 67 conducting security missions on Rte BRONZE, Engr work parties at laterite pit and Frenchman's Flat Rock Quarry, and Village Chief of TAN THUOC KHANH. 2/2 Inf with B/2/34 Arm (-) continued Op LAM SON 67 conducting S&D ops in AO DARING. D/1/4 Cav (-) remained Div Trps. 1/7 Arty (-) remained in DS of 2d Bde.

30 May: 2d Bde continued Op LAM SON 67. 1/18 Inf remained OIFCON 3d Bde. 2/18 Inf remained OIFCON 1st Bde. 2/16 Inf continued Op LAM SON 67 conducting security missions on Rte BRONZE, Engr work parties at laterite pit and

CONFIDENTIAL

CONFIDENTIAL

46

Frenchman's Flat Rock Quarry, and Village Chief of TAN THUOC KHANH. 2/2 Inf (-) with B/2/34 Arm (-) continued Op LAM SON 67 conducting S&D ops in AO DARING. D/1/4 Cav (-) remained Div Trps. 1/7 Arty (-) continued in DS of 2d Bde.

31 May: 2d Bde continued Op LAM SON 67. 1/18 Inf remained OFCON 3d Bde 2/18 Inf remained OFCON 1st Bde. 2/16 Inf continued Op LAM SON 67 conducting security missions on Rte BRONZE, Engr work parties at laterite pit and Frenchman's Flat Rock Quarry, and Village Chief of TAN THUOC KHANH. 2/2 Inf (-) with B/2/34 Arm (-) continued Op LAM SON 67 conducting S&D ops in AO DARING.

1 June: 2d Bde continued Op LAM SON 67. 1/18 Inf remained OFCON 3d Bde. 2/18 Inf airlifted to DI AN with all elements closing at 1430H. 2/16 Inf continued Op LAM SON 67 conducting security missions on Rte BRONZE, Engr work parties at laterite pit and Frenchman's Flat Rock Quarry, and Village Chief of TAN THUOC KHANH. 2/2 Inf with B/2/34 Arm (-) terminated S&D ops in AO DARING and commenced move to LAI KHE. D/1/4 Cav (-) remained Div Trps. 1/7 Arty (-) continued in DS of 2d Bde.

2 June: 2d Bde continued Op LAM SON 67. 1/18 Inf remained OFCON 3d Bde. 2/18 Inf stood down for maintenance and prepared for future operations. 2/16 Inf continued Op LAM SON 67 conducting security missions on Rte BRONZE, Engr work parties at laterite pit and Frenchman's Flat Rock Quarry, and Village Chief of TAN THUOC KHANH. B/2/34 Arm (-) stood down at DI AN conducting maintenance. 1/7 Arty (-) continued in DS of 2d Bde.

3 June: 2d Bde continued Op LAM SON 67. 1/18 Inf at 1240H relieved 2/16 Inf of security men on Rte BRONZE, Engr work parties at laterite pit and Frenchman's Flat Rock Quarry, and Village Chief of TAN THUOC KHANH. 2/16 Inf continued Op LAM SON 67 conducting security missions on Rte BRONZE, Engr work parties at laterite pit and Frenchman's Flat Rock Quarry, and Village Chief of TAN THUOC KHANH until relieved by 2/18 Inf at 1240H. 1/7 Arty (-) continued in DS of 2d Bde.

4 June: 2d Bde continued Op LAM SON 67. 1/18 Inf remained OFCON 1st Bde. 2/18 Inf continued Op LAM SON 67 conducting security missions on Rte BRONZE, Engr work parties at laterite pit and Frenchman's Flat Rock Quarry and Village Chief of TAN THUOC KHANH. 2/16 Inf continued to stand down at DI AN and prepared for future ops. 1/7 Arty (-) continued in DS of 2d Bde.

5 June: 2d Bde continued Op LAM SON 67. 1/18 Inf remained OFCON 1st Bde. 2/18 Inf continued Op LAM SON 67 conducting security missions on Rte BRONZE, Engr work parties at laterite pit and Frenchman's Flat Rock Quarry, and Village Chief of TAN THUOC KHANH. 2/16 Inf continued to stand down at DI AN and prepared for future ops. 1/7 Arty (-) continued in DS of 2d Bde.

6 June: 2d Bde continued Op LAM SON 67 and commenced S&D in AO STRIKE. 1/18 Inf became OFCON 2d Bde 0700H and conducted S&D in AO STRIKE. 2/18 Inf continued Op LAM SON 67 conducting security missions on Rte BRONZE, Engr work parties at laterite pit and Frenchman's Flat Rock Quarry and Village Chief of TAN THUOC KHANH. 2/16 Inf airlifted from DI AN into AO STRIKE vic XT782227 commencing 1320H. 1/7 Arty (-) continued in DS of 2d Bde.

7 June: 2d Bde continued Op LAM SON 67 and S&D in AO STRIKE. 1/18 Inf continued to stand down at DI AN. 2/18 Inf continued Op LAM SON 67 conducting security missions on Rte BRONZE, Engr work parties at laterite pit and Frenchman's Flat Rock Quarry and Village Chief of TAN THUOC KHANH. 2/16 Inf continued S&D ops in AO STRIKE without incident. D/1/4 Cav continued VR's & Eagle Flights in AO's LAM SON & STRIKE. 1/7 Arty (-) continued in DS of 2d Bde.

8 June: 2d Bde continued Op LAM SON 67 and S&D in AO STRIKE. 1/18 Inf continued to stand down at DI AN and prepared for future ops. 2/18 Inf continued Op LAM SON 67 conducting security missions on Rte BRONZE, Engr work parties at laterite pit and Frenchman's Flat Rock Quarry and Village Chief of TAN THUOC KHANH. 2/16 Inf continued S&D ops in AO STRIKE. D/1/4 Cav continued VR's & Eagle Flights in AO's LAM SON & STRIKE. 1/7 Arty (-) continued in DS of 2d Bde.

9 June: 2d Bde continued Op LAM SON 67 and S&D in AO STRIKE. 1/18 Inf continued security ops at DI AN and prepared for future ops. 2/18 Inf continued Op LAM SON 67 conducting security missions on Rte BRONZE, Engr work

CONFIDENTIAL

47

CONFIDENTIAL

parties at laterite pit and Frenchman's Flat Rock Quarry and Village Chief of TAN THUOC KHANH until 0900H. 2/16 Inf continued S&D ops in AO STRIKE. D/1/4 Cav continued VR's & Eagle Flights in AO's LAM SON & STRIKE. 1/7 Arty (-) continued in DS of 2d Bde.

10 June: 2d Bde continued Op LAM SON and S&D in AO STRIKE. 1/18 Inf moved to LAI KHE commencing 0943H. 2/18 Inf was relieved of Frenchman's Flat Rock Quarry and Village Chief of TAN THUOC KHANH at 0940H by 2/2 Inf. 2/16 Inf continued S&D ops in AO STRIKE until 1400H when Dn commenced airlift to THUOC VINH. 1/4 Cav (-) became OFCON 2d Bde. D/1/4 Cav continued VR's and Eagle Flights in AO's LAM SON & STRIKE. 1/7 Arty (-) continued in DS of 2d Bde.

11 June: 2d Bde continued Op LAM SON 67. 1/18 Inf remained OFCON 3d Bde. 2/18 Inf remained OFCON 3d Bde. 2/2 Mech continued Op LAM SON 67 conducting security msns on Rte BRONZE, Engr work parties at laterite pit and Rock Quarry, and Village Chief of TAN THUOC KHANH. 1/4 Cav continued Op LAM SON 67 initiating S&D ops in ONG DONG Jungle. 1/7 Arty continued in DS of 2d Bde.

12 June: 2d Bde continued Op LAM SON 67. 1/18 Inf remained OFCON 3d Bde. 2/18 Inf remained OFCON 3d Bde. 2/16 Inf remained OFCON 1st Bde. 2/2 Mech continued Op LAM SON 67 conducting security msns on Rte BRONZE, Engr work parties at laterite pit and Rock Quarry, and Village Chief of TAN THUOC KHANH. 1/4 Cav continued Op LAM SON 67 conducting S&D ops in ONG LONG Jungle. 1/7 Arty continued in DS of 2d Bde.

13 June: 2d Bde continued Op LAM SON 67. 1/18 Inf remained OFCON 3d Bde. 2/18 Inf remained OFCON 3d Bde. 2/16 Inf remained OFCON 1st Bde. 2/2 Mech continued Op LAM SON 67 conducting security msns on Rte BRONZE, Engr work parties at laterite pit and Rock Quarry, and Village Chief of TAN THUOC KHANH. 1/4 Cav continued Op LAM SON 67 conducting S&D ops in ONG DONG Jungle. 1/7 Arty continued in DS of 2d Bde.

14 June: 2d Bde continued Op LAM SON 67. 1/18 Inf remained OFCON 3d Bde. 2/18 Inf remained OFCON 3d Bde. 2/16 Inf remained OFCON 1st Bde. 2/2 Mech continued Op LAM SON 67 conducting security msns at Rock Quarry, Village Chief of TAN THUOC KHANH and prepared for future ops. 1/4 Cav continued Op LAM SON 67 conducting security ops on Rte BRONZE without incident. 1/7 Arty continued in DS of 2d Bde.

15 June: 2d Bde continued Op LAM SON 67. 1/18 Inf remained OFCON 3d Bde. 2/18 Inf remained OFCON 3d Bde. 2/16 Inf remained OFCON 1st Bde. 2/2 Mech continued Op LAM SON 67 conducting security msns on Rte BRONZE, Engr work parties at laterite pit and Rock Quarry, and Village Chief of TAN THUOC KHANH. 1/4 Cav continued Op LAM SON 67 conducting S&D ops in ONG DONG Jungle. 1/7 Arty continued in DS of 2d Bde.

16 June: 2d Bde continued Op LAM SON 67. 1/18 Inf remained OFCON 3d Bde. 2/18 Inf remained OFCON 3d Bde. 2/16 Inf remained OFCON 1st Bde. 2/2 Mech continued Op LAM SON 67 conducting security msns at Rock Quarry, Village Chief of TAN THUOC KHANH. 1/4 Cav continued Op LAM SON 67 conducting security ops on Rte BRONZE without incident. 1/7 Arty continued in DS of 2d Bde.

17 June: 2d Bde continued Op LAM SON 67. 1/18 Inf remained OFCON 3d Bde. 2/18 Inf remained OFCON 3d Bde. 2/16 Inf remained OFCON 1st Bde. 2/2 Mech continued Op LAM SON 67 conducting security msns at Rock Quarry, Village Chief of TAN THUOC KHANH and prepared for future ops. 1/7 Arty continued in DS of 2d Bde.

18 June: 2d Bde in conjunction with DINH DUONG Sector conducted raids on reported tunnel locations at objectives X (XT852246), Y (XT865237) and Z (XT855260). 1/18 Inf remained OFCON 3d Bde. 2/18 Inf remained OFCON 3d Bde. 2/16 Inf remained OFCON 1st Bde. 1/4 Cav continued Op LAM SON 67 conducting security ops on Rte BRONZE, at Rock Quarry and Village Chief of TAN THUOC KHANH. 1/7 Arty continued in DS of 2d Bde.

19 June: 2d Bde continued Op LAM SON 67. 1/18 Inf remained OFCON 3d Bde. 2/18 Inf remained OFCON 3d Bde. 2/16 Inf remained OFCON 1st Bde.

CONFIDENTIAL

42

CONFIDENTIAL

1/4 Cav continued Op LAM SON 67 with 2 Flats of B/2/34 Arm and a Flat of A/5/2 Arty conducting security ops on Rte BRONZE, at Rock Quarry and Village Chief of TAN THUOC KHANH. 1/7 Arty continued in DS of 2d Bde.

20 June: 2d Bde continued Op LAM SON 67. 1/18 Inf remained OFCON 3d Bde. 2/18 Inf remained OFCON 3d Bde. 2/16 Inf remained OFCON 1st Bde. 1/4 Cav (-) with 2 Flats of B/2/34 Arm and 1 Flat A/5/2 Arty conducted security ops on Rte BRONZE, at Rock Quarry and with Village Chief of TAN THUOC KHANH. 1/7 Arty continued in DS of 2d Bde.

21 June: 2d Bde continued Op LAM SON 67. 1/18 Inf remained OFCON 3d Bde. 2/18 Inf remained OFCON 3d Bde. 1/16 Inf remained OFCON 1st Bde. 1/4 Cav (-) with 2 Flats of A/2/34 Arm and 1 Flat A/5/2 Arty conducted security ops on Rte BRONZE, at Rock Quarry and with Village Chief of TAN THUOC KHANH. 1/7 Arty continued in DS of 2d Bde.

22 June: 2d Bde continued Op LAM SON 67. 1/18 Inf remained OFCON 3d Bde. 2/18 Inf remained OFCON 3d Bde. 2/16 Inf remained OFCON 1st Bde. 1/4 Cav (-) with 2 Flats of B/2/34 Arm and 1 Flat A/5/2 Arty conducted security ops on Rte BRONZE, Hwy 13, at Rock Quarry and with Village Chief of TAN THUOC KHANH and conducted S&D ops in sector. 1/7 Arty continued in DS of 2d Bde.

23 June: 2d Bde continued Op LAM SON 67. 1/18 Inf (-) closed DI AN 1830H reverting OFCON 2d Bde. 2/18 Inf remained OFCON 3d Bde. 2/16 Inf remained OFCON 1st Bde. 1/4 Cav (-) with 2 Flats of A/2/34 Arm and 1 Flat A/5/2 Arty conducted security ops on Rte BRONZE, Hwy 13, at Rock Quarry and with Village Chief of TAN THUOC KHANH and conducted S&D ops in sector.

24 June: 2d Bde continued Op LAM SON 67. 1/18 Inf (-) conducted local security at DI AN and prepared for future ops. 2/18 Inf remained OFCON 3d Bde. 2/16 Inf remained OFCON 1st Bde. 1/4 Cav (-) with 2 Flats of A/2/34 Arm and 1 Flat A/5/2 Arty conducted security ops on Rte BRONZE, at Rock Quarry and with Village Chief of TAN THUOC KHANH. 1/7 Arty continued in DS of 2d Bde.

25 June: 2d Bde continued Op LAM SON 67. 1/18 Inf conducted security missions at Rock Quarry and with Village Chief of TAN THUOC KHANH and prepared for cordon and search op at LONG T.M (XT935052). 2/18 Inf remained OFCON 3d Bde. 2/16 Inf remained OFCON 1st Bde. 1/4 Cav (-) at 0938H moved from THU LOI to LAI KHE closing at 1120H and becoming OFCON 1st Bde. A/5/2 Arty (-) conducted road clearing and security on Rte BRONZE. 1/7 Arty continued in DS of 2d Bde.

26 June: 2d Bde continued Op LAM SON 67. 1/18 Inf (-) conducted mns at Rock Quarry and with Village Chief of TAN THUOC KHANH and participated in cordon and search op at DONG TAM (XT935052), maintaining seal of the hamlet throughout the night and during the search which was completed by 1100H. 2/18 Inf (-) after being airlifted to BIEN HOA departed by road to DI AN closing at 1912H, reverting OFCON 2d Bde. 2/16 Inf remained OFCON 1st Bde. 1/7 Arty continued in DS of 2d Bde.

27 June: 2d Bde continued Op LAM SON 67. 1/18 Inf conducted local security ops at DI AN. 2/18 Inf (-) conducted local security and relieved 1/18 Inf (-) of security mns at the Rock Quarry and the Village Chief of TAN THUOC KHANH. 2/16 Inf remained OFCON 1st Bde. A/5/2 Arty (-) conducted road clearing and security on Rte BRONZE. 1/7 Arty continued in DS of 2d Bde.

28 June: 2d Bde continued Op LAM SON 67. 1/18 Inf (-) departed DI AN at 0825H and closed field locations at 0955H for Op UNIONTOWN. 2/18 Inf conducted security mns at the Rock Quarry and the Village Chief of TAN THUOC KHANH, secured Rome Flows and conducted S&D ops in BINH TRI Woods. 2/16 Inf remained OFCON 1st Bde. A/5/2 Arty conducted road clearing and security on Rte BRONZE. 1/7 Arty continued in DS of 2d Bde.

29 June: 2d Bde continued Op LAM SON 67. 1/18 Inf (-) with (Mech) remained OFCON 9th Div for Op UNIONTOWN. 2/18 Inf (-) conducted mns at the Rock Quarry and the Village Chief of TAN THUOC KHANH; secured Rome Flows and conducted S&D ops in BINH TRI Woods. 2/16 Inf remained OFCON 1st Bde. 2/28 Inf closed THU LOI at 1420H becoming OFCON 2d Bde. A/5/2 Arty (-) conducted road clearing and security on Rte BRONZE. 1/7 Arty continued in DS of 2d Bde.

CONFIDENTIAL

49

CONFIDENTIAL

30 June: 2d Bde continued Op LAM SON 67. 1/18 Inf (-) with L/2/2 Inf (Mech) remained OFCON 9th Div for Op UNIONTOWN. 2/18 Inf (-) conducted security mns at the Rock Quarry and the Village Chief of TAN THUOC KHANH, secured Rome Flows and sealed sector of village BINH CHUAN by 0359H. 2/16 Inf remained OFCON 1st Bde. 2/28 Inf moved from THU LOI at 0148H to seal a sector of BINH CHUAN by 0359H. D/1/4 Cav (-) conducted VR's at vic XT7917, XT7918, XT8118 and XT8218 commencing at 0614H. A/5/2 Arty conducted road clearing and security on Rte BRONZE. 1/7 Arty continued in DS of 2d Bde.

1 July: 2d Bde continued Op LAM SON 67. 1/18 Inf rear elements at DI AN conducted a sod size recon patrol N of DI AN and positioned a night ambush vic XT893094. 2/18 Inf conducted S&D ops in BINH TRI Woods. 2/16 Inf remained OFCON 1st Bde. D/1/4 Cav became OFCON 2d Bde at 1109H for a coordinated US/ARVN raid on reported VC meeting in THU CHANH. 1/7 Arty continued in DS of 2d Bde.

2 July: 2d Bde continued Op LAM SON 67. 1/18 Inf (-) with Co B 2/2 Inf (Mech) remained OFCON 9th Div for Op UNIONTOWN. 2/18 Inf conducted security mns at the Rock Quarry and Village Chief of TAN THUOC KHANH, secured Rome Flows, and continued conducting S&D ops in BINH TRI Woods. 2/16 Inf remained OFCON 1st Bde. D/1/4 Cav (-) ARFs were scrambled at 0745H to secure downed acft vic XT760309. A/5/2 Arty (-) conducted road clearing and security on Rte BRONZE. 1/7 Arty continued in DS of 2d Bde.

3 July: 2d Bde continued Op LAM SON 67. 1/18 Inf (-) with Co B 2/2 Inf (Mech) remained OFCON 9th Div for Op UNIONTOWN. 2/18 Inf conducted security mns at the Rock Quarry and Village Chief of TAN THUOC KHANH, secured Rome Flows, and continued conducting S&D ops in BINH TRI Woods. 2/16 Inf remained OFCON 1st Bde. A/5/2 Arty (-) conducted road clearing and security on Rte BRONZE. 1/7 Arty continued in DS of 2d Bde.

4 July: 2d Bde continued Op LAM SON 67. 1/18 Inf (-) with Co B 2/2 Inf (Mech) remained OFCON 9th Div for Op UNIONTOWN. 2/18 Inf conducted security mns at the Rock Quarry and Village Chief of TAN THUOC KHANH, secured Rome Flows, and continued conducting S&D ops in BINH TRI Woods. 2/16 Inf remained OFCON 1st Bde. A/5/2 Arty (-) conducted road clearing and security on Rte BRONZE. 1/7 Arty continued in DS of 2d Bde.

5 July: 2d Bde continued Op LAM SON 67. 1/18 Inf (-) with Co B 2/2 Inf (Mech) remained OFCON 9th Div for Op UNIONTOWN. 2/18 Inf conducted security mns at the Rock Quarry and Village Chief of TAN THUOC KHANH, secured Rome Flows, and continued conducting S&D ops in BINH TRI Woods. 2/16 Inf remained OFCON 1st Bde. A/5/2 Arty (-) with 1 Flat C/1/4 Cav conducted road clearing and security on Rte BRONZE. 1/7 Arty continued in DS of 2d Bde.

6 July: 2d Bde continued Op LAM SON 67. 1/18 Inf with E/2/2 Inf (Mech) remained OFCON 9th Div for Op UNIONTOWN. 2/18 Inf conducted security mns at the Rock Quarry and Village Chief of TAN THUOC KHANH, secured Rome Flows, and continued conducting S&D ops in BINH TRI Woods. 2/16 Inf (-) remained OFCON 1st Bde. A/5/2 Arty (-) with 1 Flat C/1/4 Cav conducted road clearing and security on Rte BRONZE. 1/7 Arty continued in DS of 2d Bde.

7 July: 2d Bde continued Op LAM SON 67. 1/18 Inf (-) with L/2/2 Inf (Mech) remained OFCON 9th Div for Op UNIONTOWN. 2/18 Inf conducted security mns at the Rock Quarry and Village Chief of TAN THUOC KHANH until released by C/1/4 Cav by 0920H. 2/16 Inf (-) was airlifted from CUAN LOI with first Acft arriving at BIEN HOA at 1055H and the last at 1501H becoming OFCON 2d Bde. 2d Bde School conducted three recon patrols E & SE of DI AN. A/5/2 Arty (-) with 1 Flat C/1/4 Cav conducted road clearing and security on Rte BRONZE. 1/7 Arty continued in DS of 2d Bde.

8 July: 2d Bde continued Op LAM SON 67. 1/18 Inf (-) with L/2/2 Inf (Mech) remained OFCON 9th Div for Op UNIONTOWN. 2/18 Inf (-) remained OFCON 1st Bde. 2/16 Inf (-) elements relieved Trp C/1/4 Cav of security missions at Rock Quarry and for Village Chief of TAN THUOC KHANH. 2/16 Inf (-) with E/1/18 Inf became OFCON 2d Bde upon closing THU LOI. 1/4 Cav (-) with elements of A/5/2 Arty (-) and L/2/34 Arm (-) became OFCON 2d Bde at 0700H and assumed security missions of Rte BRONZE, Rome Flows, and responsibility of convoy escort. 1/7 Arty continued in DS of 2d Bde.

CONFIDENTIAL

9 July: 2d Bde continued Op LAM SON 67. 1/18 Inf (-) with B/2/2 Inf (Mech) remained OFCON 9th Div for Op UNIONTOWN. 2/18 Inf (-) remained OFCON 1st Bde. 2/16 Inf (-) elements continued security missions at Rock Quarry and for Village Chief of TAN PHUOC KHANH. 2/2 Inf (-) with B/2/2 Inf completed seal of their sector of THUAN GIAO by 0100H and maintained seal throughout the night and during the search. 1/4 Cav (-) with elements of A/5/2 Arty (-) and B/2/34 Arm (-) continued security missions of Route BRONZE, Rome Flows, responsibility of convoy escort and conducted S&D ops in sector. 1/7 Arty continued in DS of 2d Bde.

10 July: 2d Bde continued Op LAM SON 67. 1/18 Inf (-) with B/2/2 Inf (Mech) remained OFCON 9th Div for Op UNIONTOWN. 2/18 Inf (-) remained OFCON 1st Bde. 2/16 Inf (-) elements continued security missions at Rock Quarry and for Village Chief of TAN PHUOC KHANH; conducted local security missions and prepared for future ops. 2/2 Inf (Mech) (-) with B/1/18 Inf and one Plat B/2/34 Arm conducted S&D ops south of KHANH VAN at vic XT920150 and XT908147. 1/4 Cav (-) with elements of A/5/2 Arty (-) and B/2/34 Arm (-) continued security missions of Rte BRONZE, Rome Flows, responsibility of convoy escort and conducted S&D ops in sector. 2d Bde School elements positioned 2 night ambushes vic XT894077 and XT902085. 1/7 Arty continued in DS of 2d Bde.

11 July: 2d Bde continued Op LAM SON 67. 1/18 Inf (-) with B/2/2 Inf (Mech) remained OFCON 9th Div for Op UNIONTOWN. 2/18 Inf (-) remained OFCON 1st Bde. 2/16 Inf (-) elements continued security missions at Rock Quarry and for Village Chief of TAN PHUOC KHANH, conducted local security missions. 2/2 Inf (Mech) (-) with B/1/18 Inf conducted local security mns at PHU LOI. 1/4 Cav (-) with elements of A/5/2 Arty (-) and B/2/34 Arm (-) continued security missions of Rte BRONZE, Rome Flows, responsibility of convoy escort and conducted S&D ops in sector. 1/7 Arty continued in DS of 2d Bde.

12 July: 2d Bde continued Op LAM SON 67. 1/18 Inf (-) with B/2/2 Inf (Mech) remained OFCON 9th Div for Op UNIONTOWN. 2/18 Inf (-) remained OFCON 1st Bde. 2/16 Inf (-) elements continued security missions at Rock Quarry and for Village Chief of TAN PHUOC KHANH. 2/2 Inf (Mech) (-) completed seal of their sector of VINH TRUONG by C437 and maintained seal throughout the night and during search. 1/4 Cav (-) with elements of A/5/2 Arty (-) and B/2/34 Arm (-) continued security missions of Rte BRONZE, Rome Flows, responsibility of convoy escort and conducted S&D ops in sector. 1/7 Arty continued in DS of 2d bde.

13 July: 2d Bde continued Op LAM SON 67. 1/18 Inf with B/2/2 Inf (Mech) remained OFCON 9th Div for Op UNIONTOWN. 2/18 Inf (-) remained OFCON 1st Bde. 2/16 Inf elements continued security missions at Rock Quarry and for Village Chief of TAN PHUOC KHANH. 2/2 Inf (Mech) (-) conducted joint S&D ops in conjunction with 5th ARVN Div and BINH DUONG Sector vic XT826198. 1/4 Cav (-) with element of A/5/2 Arty (-) and B/2/34 Arm (-) continued security missions of Rte BRONZE, Rome Flows, responsibility of convoy escort and conducted S&D ops in sector. 1/7 Arty continued in DS of 2d Bde.

14 July: 2d Bde cont Op LAM SON 67. 1/18 Inf with B/2/2 Inf (Mech) remained OFCON 9th Div for Op UNIONTOWN. 2/18 Inf (-) remained OFCON 1st Bde. 2/16 Inf elements continued security missions at Rock Quarry and for Village Chief of TAN PHUOC KHANH. 2/2 Inf (Mech) (-) with B/1/7 Arty in DS conducted S&D ops vic XT773230. 1/4 Cav (-) with elements of A/5/2 Arty (-) and B/2/34 Arm (-) continued security missions of Rte BRONZE, Rome Flows, responsibility of convoy escort and conducted S&D ops in sector. 1/7 Arty continued in DS of 2d Bde.

15 July: 2d Bde continued Op LAM SON 67. 1/18 Inf with B/2/2 Inf (Mech) remained OFCON 9th Div for Op UNIONTOWN. 2/18 Inf (-) remained OFCON 1st Bde. 2/16 Inf elements continued security missions at Rock Quarry and for Village Chief of TAN PHUOC KHANH. 2/2 Inf (Mech) elements provided security for Engr elements repairing Hwy commencing 1320H. 1/4 Cav (-) with element of A/5/2 Arty (-) and B/2/34 Arm (-) continued security missions of Rte BRONZE, Rome Flows, responsibility of convoy escort and conducted S&D ops in sector. 1/7 Arty continued in DS of 2d Bde.

16 July: 2d Bde continued Op LAM SON 67. 1/18 Inf with B/2/2 Inf (Mech) remained OFCON 9th Div for Op UNIONTOWN. 2/18 Inf (-) remained OFCON 1st Bde. 2/16 Inf elements continued security missions at Rock Quarry and for Village Chief of TAN PHUOC KHANH. 2/2 Inf (Mech): Co A provided security

CONFIDENTIAL

51

for Engr work parties vic XT918205 and XT923202. 1/4 Cav (-) with elements of A/5/2 Arty (-) and B/2/34 Arm (-) continued security missions on Route BRONZE, responsibility of convoy escort and conducted S&D ops in sector. Rte BRONZE was cleared and outposted by 0745H. 1/7 Arty continued in DS of 2d Bde.

17 July: 2d Bde continued Op LAM SON 67. 1/18 Inf with B/2/2 Inf (Mech) remained OPCON 9th Div for Op UNIONTOWN. 2/18 Inf (-) remained OPCON 1st Bde. 2/16 Inf elements continued security missions at Rock Quarry and for Village Chief of TAN PHUOC KHANH. 2/2 Inf (Mech) (-) continued security of FSB "C" and Engr work parties vic KHANH VAN with Co A and Recon Plat. 1/4 Cav (-) with elements of A/5/2 Arty (-) and B/2/34 Arm (-) continued security missions on Rte BRONZE, responsibility of convoy escort and conducted S&D ops in sector. 1/7 Arty continued in DS of 2d Bde.

18 July: 2d Bde continued Op LAM SON 67. 1/18 Inf (-) with B/2/2 Inf (Mech) terminated participation in Op UNIONTOWN. 2/18 Inf (-) remained OPCON 1st Bde. 2/16 Inf elements continued security missions at Rock Quarry and for Village Chief of TAN PHUOC KHANH. 2/2 Inf (Mech) (-) continued security of FSB "C" and Engr work parties vic KHANH VAN with Co A and Recon Plat. 1/4 Cav (-) with elements of A/5/2 Arty (-) and B/2/34 Arm (-) continued security missions on Rte BRONZE, responsibility of convoy escort and conducted S&D ops in sector. 1/7 Arty continued in DS of 2d Bde.

19 July: 2d Bde continued Op LAM SON 67. 1/18 Inf continued local security missions at DI AN and prepared for future ops. 2/18 Inf (-) remained OPCON 1st Bde. 2/16 Inf elements continued security missions at Rock Quarry and for Village Chief of TAN PHUOC KHANH. 2/2 Inf (Mech) continued local security missions at PHU LOI and security of FSB "C". 1/4 Cav (-) with elements of A/5/2 Arty (-) continued security missions on Rte BRONZE and responsibility of convoy escort. 1/7 Arty continued in DS of 2d Bde.

20 July: 2d Bde continued Op LAM SON 67. 1/18 Inf continued local security missions at DI AN and prepared for future ops. 2/18 Inf (-) remained OPCON 3d Bde. 2/16 Inf elements continued security missions at Rock Quarry and for Village Chief of TAN PHUOC KHANH. 2/2 Inf (Mech) with B/2/34 Arm and elements of A/168 Engr and B/1 Engr commenced jungle clearing ops at 0726H. 1/4 Cav (-) with elements of A/5/2 Arty (-) continued security missions on Route BRONZE and responsibility of convoy escort. 1/7 Arty continued in DS of 2d Bde.

21 July: 2d Bde continued Op LAM SON 67. 1/18 Inf remained OPCON 1st Bde. 2/18 Inf (-) remained OPCON 3d Bde. 2/16 Inf elements continued security missions at Rock Quarry and for Village Chief of TAN PHUOC KHANH. 2/2 Inf (Mech) with B/2/34 Arm and elements of A/168 Engr and B/1 Engr continued Op PAUL BUNYAN. 1/4 Cav (-) with elements of A/5/2 Arty (-) continued security missions on Rte BRONZE and responsibility of convoy escort. 1/7 Arty continued in DS of 2d Bde.

22 July: 2d Bde continued Op LAM SON 67. 1/18 Inf remained OPCON 1st Bde. 2/18 Inf (-) remained OPCON 3d Bde. 2/16 Inf elements continued security missions at Rock Quarry and for Village Chief of TAN PHUOC KHANH. 2/2 Inf (Mech) with B/2/34 Arm and elements of A/168 Engr and B/1 Engr continued Op PAUL BUNYAN. 1/4 Cav (-) with elements of A/5/2 Arty (-) continued security missions on Rte BRONZE and responsibility of convoy escort. 1/7 Arty continued in DS of 2d Bde.

23 July: 2d Bde continued Op LAM SON 67. 1/18 Inf remained OPCON 1st Bde. 2/18 Inf remained OPCON 3d Bde. 2/16 Inf elements continued security missions at Rock Quarry and for Village Chief of TAN PHUOC KHANH. 2/2 Inf (Mech) with B/2/34 Arm and elements of A/168 Engr continued Op PAUL BUNYAN. 2/28 Inf was airlifted commencing 1415H from AO STRIKE to DI AN, becoming OPCON 2d Bde. 1/4 Cav (-) with elements of A/5/2 Arty (-) continued security missions on Rte BRONZE and responsibility of convoy escort. 1/7 Arty continued in DS of 2d Bde.

24 July: 2d Bde continued Op LAM SON 67. 1/18 Inf remained OPCON 1st Bde. 2/18 Inf remained OPCON 3d Bde. 2/16 Inf elements continued security missions at Rock Quarry and for Village Chief of TAN PHUOC KHANH. 2/2 Inf (Mech) with B/2/34 Arm and elements of A/168 Engr and B/1 Engr continued Op

CONFIDENTIAL

46

CONFIDENTIAL

PAUL BUNYAN. 2/28 Inf conducted local security msns at DI AN and prepared for future op. 1/4 Cav (-) with elements of A/5/2 Arty (-) continued security missions on Route BRONZE and responsibility of convoy escort. 1/7 Arty continued in DS of 2d Bde.

25 July: 2d Bde continued Op LAM SON 67. 1/18 Inf remained OFCON 1st Bde. 2/18 Inf remained OFCON 3d Bde. 2/16 Inf elements continued security missions at Rock Quarry and for Village Chief of TAN PHUOC KHANH. 2/2 Inf (Mech) with B/2/34 Arm and elements of A/168 Engr and B/1 Engr continued Op PAUL BUNYAN. 2/28 Inf conducted local security msns at DI AN. 1/4 Cav (-) with elements of A/5/2 Arty (-) continued security missions on Route BRONZE and responsibility of convoy escort. 1/7 Arty continued in DS of 2d Bde.

26 July: 2d Bde continued Op LAM SON 67. 1/18 Inf remained OFCON 1st Bde. 2/18 Inf remained OFCON 3d Bde. 2/16 Inf elements continued security missions at Rock Quarry and for Village Chief of TAN PHUOC KHANH. 2/2 Inf (Mech) with B/2/34 Arm and elements of A/168 Engr and B/1 Engr continued Op PAUL BUNYAN. 2/28 Inf completed its portion of the seal of PHU CHANH. 1/4 Cav (-) with elements of A/5/2 Arty (-) continued security missions on Rte BRONZE, responsibility of convoy escort, and conducted S&D ops in ONG DONG Jungle. 1/7 Arty continued in DS of 2a Bde.

27 July: 2d Bde continued Op LAM SON 67. 1/18 Inf remained OFCON 1st Bde. 2/18 Inf remained OFCON 3d Bde. 2/16 Inf elements continued security missions at Rock Quarry and for Village Chief of TAN PHUOC KHANH. 2/2 Inf (Mech) with B/2/34 Arm and elements of A/168 Engr and B/1 Engr continued Op PAUL BUNYAN. 2/28 Inf continued to maintain its portion of seal of PHU CHANH. 1/4 Cav (-) with elements of A/5/2 Arty (-) continued security missions on Rte BRONZE, responsibility of convoy escort, and conducted S&D ops in ONG DONG Jungle. 1/7 Arty continued in DS of 2d Bde.

28 July: 2d Bde continued Op LAM SON 67. 1/18 Inf remained OFCON 1st Bde. 2/18 Inf remained OFCON 3d Bde. 2/16 Inf elements continued security missions at Rock Quarry and for Village Chief of TAN PHUOC KHANH. 2/2 Inf (Mech) with B/2/34 Arm and elements of A/168 Engr and B/1 Engr (-) continued Op PAUL BUNYAN. 1/4 Cav (-) with elements of A/5/2 Arty (-) continued security missions on Rte BRONZE, responsibility of convoy escort, and conducted S&D ops in ONG DONG Jungle. 1/7 Arty continued in DS of 2d Bde.

29 July: 2d Bde continued Op LAM SON 67. 1/18 Inf commenced airliftin from LAI KHE at 1340H and air assaulted in the vic PHU CHANH. 2/18 Inf remained OFCON 3d Bde. 2/16 Inf elements continued security missions at Rock Quarry and for Village Chief of TAN PHUOC KHANH. 2/2 Inf (Mech) with B/2/34 Arm and elements of A/168 Engr and B/1 Engr (-) continued Op PAUL BUNYAN. 1/4 Cav (-) with elements of A/5/2 Arty (-) continued security missions on Rte BRONZE, responsibility of convoy escort, and conducted S&D operations in ONG DONG Jungle.

30 July: 2d Bde continued Op LAM SON 67. 1/18 Inf remained OFCON 1st Bde. 2/18 Inf remained OFCON 3d Bde. 2/16 Inf became OFCON 1st Bde at 0700H and airlifted into AO STRIKE. 2/2 Inf (Mech) with B/2/34 Arm and elements of A/168 Engr and B/1 Engr (-) continued Op PAUL BUNYAN. 1/4 Cav (-) with elements of A/5/2 Arty (-) continued security missions on Rte BRONZE, responsibility of convoy escort, and conducted S&D operations in ONG DONG Jungle. 2/28 Inf relieved 2/16 Inf of security missions at Rock Quarry and for Village Chief of TAN PHUOC KHANH. 1/7 Arty continued in DS of 2d Bde.

31 July: 2d Bde continued Op LAM SON 67. 1/18 Inf remained OFCON 1st Bde. 2/18 Inf remained OFCON 3d Bde. 2/16 Inf remained OFCON 1st Bde. 2/2 Inf (Mech) with B/2/34 Arm and elements of A/168 Engr and B/1 Engr (-) continued Op PAUL BUNYAN. 1/4 Cav (-) with elements of A/5/2 Arty (-) continued security missions on Rte BRONZE, responsibility of convoy security mission of FSPB "K" and conducted S&D ops in ONG DONG Jungle. 2/28 Inf continued security missions at Rock Quarry and for Village Chief of TAN PHUOC KHANH and conducted S&D ops in AO DAUNTLESS. 1/7 Arty continued in DS of 2d Bde.

CONFIDENTIAL

53

CONFIDENTIAL

7. (C) Part VII: DISCUSSION AND RECOMMENDATION:

a. Psychological Operations:

(1) Discussion: During the preceding period 1 May 67 - 31 July 67, the S5 expanded psychological operations. Psychological operations consisted of ground and loudspeaker/leaflet missions in support of Brigade tactical maneuvers throughout the LAM SON area of operations. During cordon and search operations, Vietnamese psyops teams and Hoi Chanhs were utilized to conduct face to face psychological operations. Population control normally commenced with a speech by the Province Chief, the District Chief or both. The psy ops team devoted maximum effort on the following themes: Explanation of the Chieu Hoi Program; instructions on how to rally; appeals to families with relatives in the Viet Cong; appeals from Hoi Chanhs to former comrades; general Chieu Hoi Appeals stressing superior GVN and allied forces power.

(2) Recommendations:

(a) During cordon and search operations conducted by the Brigade, the seal message has been broadcast as soon as the seal is effected. Although this has reduced the possibility of innocent people getting hurt, it has also increased the warning time the VC have to escape from the village. The cordon and search operations are most effective when the seal message is broadcast shortly before search is to commence.

(b) The Brigade conducted a cordon and search operation in the village of PHU CHANH during period 25 to 27 July 67. The psy ops team flew several aerial loudspeaker missions instructing VC hiding in the village to rally while ARVN and American Forces were operating in the area. On 27 July, a guerrilla followed the instructions and rallied at the ARVN outpost location in the village. When seals are maintained for extended periods, it provides a better opportunity to exploit the operation with psychological operations.

(c) On 27 July 67, a Hoi Chanh was utilized to broadcast a Chieu Hoi Appeal to his former comrades. He instructed his former comrades to move out of the base camp to the nearest open field and wait for further instructions. While the psyops ship was broadcasting the message, there were several gunships orbiting the area. Indications are that if there were Viet Cong in the area they became suspicious of our intentions because of the number of aircraft in the area. In future operations of this type, the psy ops ship should be the only aircraft over the target area.

b. Civic Action Activities:

(1) Discussion: Construction of a self-help RF dependent housing project is presently underway in BINH DUONG Province. This project is a combined effort of 2d Bde, BINH DUONG Sector and the Office for Civilian Operations for Revolutionary Development Support in BINH DUONG Province. US participation was to be limited to heavy equipment and technical assistance, while the RF was to provide laborers. Initially an engineer platoon was committed to the project resulting in loss of active VN participation. As a result of this experience, less than one engineer squad is presently being utilized for this project. A meeting with province and RF officials to discuss future US support for this project has resulted in an agreement to provide adequate RF support for the project. Threatened withdrawal of US support from this project has induced ARVN and RF personnel to assume increased responsibilities. Operation of the BINH DUONG Dispensary in DI AN District is underway. This project is a combined effort of 2d Bde, DI AN District and the Civilian Operations for Revolutionary Development Support Agency in DI AN District. US participation is to be limited to providing technical assistance. Initially the dispensary is being run by medicals from this section and supplies are being provided through the channels. However plans are being made to train Vietnamese to run the

CONFIDENTIAL

CONFIDENTIAL

dispensary and for GVN supply channels to eventually assume the logistical support of the dispensary. In order to undertake Civic Action project of this nature, participation by the District Chief is of prime importance. The present District Chief has demonstrated more concern for the welfare of the people than the previous Chief, thus providing the atmosphere required for Civic Action projects in DI AN District. During the past quarter, the number of MEDCAP II operations has increased from an average of one per week to present tempo of five, and sometimes, six per week. Increased emphasis on MEDCAP II operations has necessitated a more scientific approach to the planning, coordination and execution of these daily operations. Many small bugs have been ironed out of the operation.

(2) Recommendation:

(a) Close and continuous (almost daily) coordination must exist between the Civic Action Officer and district officials and supporting medical units in order to produce effective and efficient MEDCAP II operations on the present scale.

(b) Though performances of the 1st Infantry Division Band and the distribution of commodities tend to detract temporarily from MEDCAP participation, they have in each instance served to increase ultimate participation by attracting larger crowds.

(c) Effective crowd control, preferably by Vietnamese military or para-military personnel, is essential in insuring a smooth operation. Surging crowds and continuous loud noise reduce the effectiveness of some medical techniques.

(d) Frequent and somewhat regular return to a MEDCAP village instills confidence in the people and makes them more willing to bring their problems to the attention of competent medical personnel.

(e) Because MEDCAP teams usually visit the centers of the various pockets of population concentration, a psychological operations loudspeaker helicopter is essential in notifying the people in outlying areas of the MEDCAP's presence and location. Response is always limited when an aerial psychological operations missions is unavailable.

(f) Because a psychological operations helicopter is frequently unavailable, extensive use of ground loudspeaker systems has become necessary. VIS can usually provide a loudspeaker lambretta and an interpreter in a jeep with a hand megaphone can also be effectively used. Neither is an acceptable substitute for a short aerial psychological operations mission.

(g) Close coordination with supporting medical units is necessary to insure that an adequate number of interpreters is available for a MEDCAP operation. Insufficient interpreter personnel reduces the effectiveness and efficiency of the operation. An interpreter from S5 should always be available.

(h) A large portion of MEDCAP patients suffer from problems caused by the unhealthful immediate environment (skin diseases, worms, etc). Treating the symptoms, but ignoring the causes, is of only limited effectiveness. Good use can be made of a public health/preventive medicine team for MEDCAP Operations.

c. Jungle Clearing Operations:

(1) Discussion:

(a) Organization for Operations: TF DARING org...

17
49

CONFIDENTIAL

CONFIDENTIAL

55-
jungle clearing operations with 3 jungle clearing teams, 1 mechanized company for NDP security and convoy escort, and Recon Platoon on road sweeping, convoy escort and battalion RRF missions. Organization of a jungle clearing team is as shown below:

1. Mech Company (-)
2. Tank Platoon
3. Engineer Plow team (9 Rome Plows, 1 Bull Blade)

This company team is further organized as follows:

Co HQ

Trail Breaking Platoon

TK Plat (-) (2 tanks and Plat HQ), 2 mechanized infantry squads.

Search Platoon

Mech Plat (-) (2 Mech squads and Plat HQ) tank section (2 tanks)

Security Platoon

Mech Plat

Engineer Plow Team

(b) Concept of Operation. The area to be cleared is saturated with artillery destruction program fires, mortar fires and pre-planned airstrikes for several days prior to commencement of clearing. Immediately prior to entry of the clearing team, an artillery and mortar preparation is fired. The company clearing team enters the area immediately after completion of the preparation. A schematic of a jungle area to be cleared is shown below. Normally one side of the area will be clear of jungle.

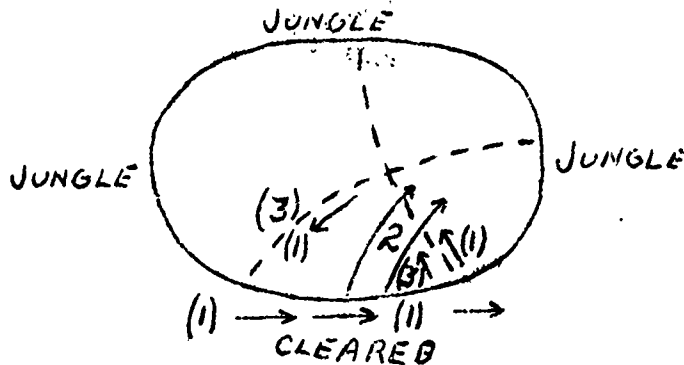

The trail breaking team proceeds along existing trails where possible, or breaks swaths through the jungle where necessary, to outline the area to be cut (1). The search team by random pattern searches the jungle to discover mines, booby traps or enemy (2). The Security Platoon accompanies the engineer plow team which clears jungle in a counterclockwise direction. On order after trail breaking and searching are completed, the plows begin clearing following the path broken by the trail team. The ACAVs of the mechanized platoon march to the flanks of the clearing plows. In close jungle, infantry dismount the more dangerous side of the broken trail. The trail breaking, search, and security teams repeat the above operation until the area is cleared. Normally the trail breaking team will be able to break trail in the first portion of the area for the following day's operation. The combined arms organization for jungle clearing of infantry, armor, and artillery supporting engineer clearing is satisfied. It is believed that fire support by air, artillery and mortars limits the

CONFIDENTIAL

CONFIDENTIAL

56

capability of the enemy to emplace mines or booby traps, and the preparation prior to entry for clearing destroys those previously emplaced.

(2) Recommendations:

(a) The organization of company clearing teams as shown in Discussion above gives the greatest security to the engineer plow teams and provides the team commander with flexibility in operations.

(b) Reconnaissance by tank cannister fire is effective in penetrating booby trapped jungle or old base camp areas.

(c) A 1500 meter buffer from units other than the clearing battalion should be maintained to permit rapid response to ambush.

(d) It is recommended that clearing operations be conducted in continuous jungle area of approximately 3000 or more acres. This eliminates frequent displacement of the NDP and employs the engineer plow teams with maximum effectiveness.

FOR THE COMMANDER

for ~~James E. Lancaster~~ *CPT*
JAMES E. LANCASTER
Captain, Infantry
Adjutant

DISTRIBUTION:

20-G3
1-1/18 Inf
1-2/18 Inf
1-2/16 Inf
1-2/2 Inf (Mch)
1-2/28 Inf
1-1/26 Inf
1-1/16 Inf
1-1/4 Cav
1-HHC, 2d Bde
1-1/7 Arty
1-B/1 Engr
1-A/168 Engr
1-B/701 Maint

THIS HQ:

1-S1
1-S2
5-S3
1-S4
1-S5

57

CONFIDENTIAL

51

CONFIDENTIAL

DEPARTMENT OF THE ARMY
HEADQUARTERS 3D BRIGADE AND LAI KHE BASE
1st Infantry Division
APO 96345

AVDB-WB-C

03 August 1967

SUBJECT: Operational Report on Lessons Learned (RCS CSGPO-28 (R1))

TO: Commanding General
1st Infantry Division
ATTN: G 3
APO US Forces 96345

1. PART-1. INTRODUCTION.

a. During the previous quarter five major unit operations were conducted. Major engagements were fought on 28 February and on 10-11 March 1967. Three major unit operations were conducted during the current reporting period, April thru June. A major engagement occurred during operation BILLINGS on 14 June 1967. At 1430 hours, Company B 1-16 Infantry made contact with a VC Battalion. Company B became heavily engaged receiving heavy fire from the front and flanks. Artillery, air strikes and gunships were utilized in support of the ground troops. By 1900 hours contact was broken. The action resulted in 60 VC KIA (BG). Again on 17 June a major engagement was fought. At LZ X-RAY, 1-16 Infantry and 2-28 Infantry became heavily engaged and received two major attacks. Here again the effective use of close air support and artillery successfully broke the attack. A follow up report of this days activities listed 196 VC KIA.

b. Component Units and Commanding Officers.

1-2 Infantry	: LTC William C.S. Simpson	
1-16 Infantry	: LTC Rufus C. Lezzell,	26 November 1966-28 June 67
	LTC Calvert P. Benedict	28 June 67 - Present
1-18 Infantry	: LTC Richard Cavazos	
1-28 Infantry	: LTC Stanley J. Kuick	
2-2 Inf(Moob)	: LTC Edward J. Collins,	22 December 1966-24 May 67
	LTC John D. Pelton,	24 May 1967-Present
2-18 Infantry	: LTC Lewis R. Baumann,	23 April-11 May
	LTC James F. Price,	11 May-Present
2-28 Infantry	: LTC Jerry S. Edwards,	15 March 67-27 June 67
	LTC Edward J. Cavanaugh	27 June 67 - Present
1-4 Cav	: LTC John W. Seigle	
1-11 ACR	: LTC Martin D. Howoll	
3-11 ACR	: LTC Frank Cochran	
2-33 Arty	: LTC Charles D. Daniels,	5-20 June
	LTC Arthur D. Wells,	20 June-Present
6-15 Arty	: LTC Frank E. Serio	

2. PART 11. NARRATIVE OF TACTICAL OPERATIONS:

a. Major operations conducted by the IRON Brigade during the reporting period include the following:

(1) Operation MANHATTAN (23 April-11 May): The initial stages of this operation as well as the intelligence coverage, terrain analysis and effects of climatic conditions were covered in the previous reporting period (23-30 April 67). The operation continued into the month of MAY with the 3d Brigade conducting search, destroy operations in the THAN DIEN forestry reserve West of LAI KHE in BINH DONG province. Small base camps, food and ammunition caches were discovered during the course of the operation. On 3 May 1967 in the vicinity XT560380 a CHIEU HOI led Company A, 2-18 Infantry to a very large weapons cache containing 220-7,92

52

CONFIDENTIAL

58

CONFIDENTIAL

Mausers rifles (147 Chicom type); 53 rifles, 20 VC claymores, 1500-60 MM Mortar rounds, 500 rifle grenades; 7500-12.7 MM LP rounds; 50 US LP mines; 7800 rounds of 50 Cal ammo; miscellaneous equipment and documents. Resistance by the VC throughout the operation was limited to harassing tactics, employing snipers and booby traps extensively.

Personnel losses for the operation were: US Losses: 8 KHA, 57 WHA, VC Losses: 58 KIA and 8 VCC. Significant VC equipment losses other those previously mentioned were: 2 RPG rocket launchers, 2000 82 MM mortar rounds, 1800 electric blasting caps, 1400 non-electric blasting caps, 100 claymore (Chicom) mines, 2363-hand grenades, 150,000 rounds small arms ammo, 900-40 MM rounds, 130 mines and booby traps, 21 tons of salt, 5.6 tons of wheat, 1.5 tons of fish, 500 gallons of cooking oil, 3.5 tons of cement and finally miscellaneous food, ammunition and equipment were destroyed.

Operation MANHATTAN was officially terminated at 112400H May 1967.

(2) Operation BLUEFIELD (5 Jun-9 Jun 1967). The mission of the IRON Brigade was to conduct a multi-battalion air and ground assault on 5 June 67 in a sector located 12 Km North and 13 Km East-Northeast of LLI KHE and to destroy VC/NVA Forces and installations within the operational area. The sector was bounded by coordinates XT7440, XT7454 and East to the SONG BE River. Units participating under 3d Brigade OPCON were: 2-2 Inf(Mech), 1-16 Inf, 1-26 Inf, 2-28 Inf, 1-4 Cav, 2-33 Arty and supporting units. The Brigade was participating in a 1st Inf Division operation. Intelligence sources revealed that since the last large operation in the assigned sector that tax collection points had been established along HWY 13. Additionally, movement of squads and Company size VC forces were reported and confirmed in the area. The actual area of operation was characterized by generally flat and broad leaf evergreen forest, intermingled with bushwood and bamboo forests in the northeast corner. The weather during the operation consisted of occasional rain and did not effect the operation. The operational area was sparsely populated with the exception of a few villages along Highway 302. The operation commenced with 1-4 Cav conducting S & D operations vic XT880450. 1-16 Infantry conducted an air assault into LZ 16 (XT875483) and 2-28 Infantry conducted an air assault into LZ 28 (XT828477). Both battalions conducted search and destroy operations in sector. 2-2 Inf(Mech) secured an artillery base vic BuU BINH on HWY 13. 1-26 Infantry secured LLI KHE. The VC apparently departed the operational area leaving small amounts of ammunition and equipment in base camps varying in size from squad to battalion. No large cache was found, however 23 unserviceable weapons were found during the operation.

Operation BLUEFIELD terminated on 9 June with the following results: 1 US KHA, 2 US WHA, 1 VC KIA(BC). There were no US equipment losses. Major VC supply losses for the operation were: 5000 lbs of rice, 20 tons of peanuts, 23 assorted weapons, 94 rounds of 50 cal. ammo and 584 rounds of assorted small arms ammunition.

(3) Operation BILLINGS (11 Jun-26 Jun 1967). Operation BILLINGS was conducted in Western WAR ZONE D. The IOPON Bde mission was to secure and occupy a FSPB (Gunner 2), conduct an air assault into LZ RUFÉ, conduct combat reconnaissance and search and destroy operations with two Infantry Battalions, kill VC/NVA personnel and destroy VC/NVA installations with the area of operations. The 3d Brigade concept of operation was as follows: Secure FSPB Gunner 2 with 2-28 Infantry commencing 11 June 1967, conduct an airmobile assault on LZ RUFÉ utilizing 1-16 Infantry on 13 June 1967, and conduct combat reconnaissance operations in sector employing 1-16 Infantry and 2-28 Infantry. Discovery of numerous large base camps within the operational area indicated the VC regularly used the area. Additional intelligence information gathered from the USSF detachment at CHI LINH confirmed large enemy unit sightings and discoveries of many base camps. The operational area was dominated by secondary forests with considerable wet land rice areas along the numerous streams scattered throughout the area. Weather during the first week of the operation consisted of heavy rainfall. This did not impede movement during the operation but did however cause air support to operate at minimum conditions. No civilian personnel were encountered by friendly elements in their maneuver area during the course of the operation.

The operation commenced on 11 Jun 67 with the 2-18 Infantry moving to and securing FSPB Gunner 2 (XT917734). On 12 June 1967, 2-28 Infantry moved to an assembly area at CHI LINH. The 3d Brigade CP also moved there. After extensive air and artillery preparation, the 1-16 Infantry conducted an air assault into LZ RUFÉ (XT954663). The 2-28 Infantry also was inserted into the LZ. 1-16 Infantry secured the northern half of the NDP and 2-28 Infantry the southern half.

CONFIDENTIAL

59
CONFIDENTIAL

On 14 June 1967, Company B, 1-16 Infantry made contact with an estimated VC Company vic XT937669. Contact continued for approximately three hours. Results were 6 US KHA, 12 US WHA; and 50 VC KIA(BC). Two medevac aircraft were damaged in an attempt to evacuate the wounded.

On 17 June 1967 at 1245 hours, 1-16 Infantry and 2-28 Infantry moved overland to a position vic XT960879 and began preparations for an NDP. The VC began firing into the perimeter from three directions. The VC then initiated a ground attack from both the Northwest and Southwest. Artillery, air and Gunships were used in repelling the enemy, and the attack was repulsed at 1345 hours. At 1700 hours, however, the position was mortared for about 10 minutes resulting in more US casualties. Results of the days activities were 30 US KHA, 108 US WHA; 196 VC KIA(BC) Company A and RECON platoon 1-16 Infantry were airlifted to CHI LINH. 2-28 Infantry with C Company 1-16 Infantry defended the position. A follow up report of the day's action listed 196 VC KIA (BC). 1-18 Infantry was inserted into the position closing at 1905 hours. On 18 June 1967, 1-16 Infantry (-) was airlifted to LAI KHE. 1-18 Infantry conducted S & D operations and discovered 22 VC bodies. On 19 June 1967, 1-28 Infantry conducted an air assault on LZ DEFIANT (XT955726) and conducted S & D operations in that general area. On 23 June 1967, 2-18 Infantry and supporting artillery were extracted from FSPB, Gunner 2 at CHI LINH. Operation BILLINGS Officially terminated on 26 June 1967 at 1838 hours. Results of the operation were 37 US KHA, 147 US WHA, 329 VC KIA(BC) and 1 VC POW.

(4) Road Clearing Operation (1-7 July 1967) (UNNAMED). The 3d brigade participated in a road clearing and convoy security mission during this operation. HWY 13 from LAI KHE to QUAN LOI was secured and cleared daily to enable resupply convoys to move fully through the sector. Units participating under 3d Brigade control were; 1-16 Infantry, 2-28 Infantry, 2-2 Infantry (Mech), 1-28 Infantry, 1-26 Infantry, 1-4 Cav (-), 2-33 Artillery, 6-15 Artillery and other combat service support units. The operation was conducted in three phases:

(a) PHASE I:

1. This phase of the operation consisted of positioning units along HWY 13 from LAI KHE to QUAN LOI and clearing the same highway. This was accomplished on 1-7 July 1967. Additionally the following FSPB's were established.

- A. QUAN LOI (XT8190)-C/7-9 Artillery, Plat/A/6-27 Artillery (175).
- B. CAISSON 1-(XT756877)-C/6-15 Artillery.
- C. CAISSON 2-(XT731818)-6-15 Artillery(-), A/8-6 Artillery, Plat/A/6-27 Artillery (8" HOW).
- D. CAISSON 3-(XT768613)-8-6 Artillery(-), C/7 Artillery, D/1-5 Artillery.
- E. CAISSON 4-(XT784543)-4/2-33 Artillery, C/2-33 Artillery.
- F. LAI KHE (XT7637), 2-33 Artillery(-), B/2-13 Artillery, B/8-6 Artillery.

2. On the first day of the operation units were positioned from LAI KHE North to CHAN THAN. 1-4 Cav(-) moved to and secured LZ TOM (XT789457). 1-16 Infantry(-) moved into LZ TOM at 010930H July 67. 1-4 Cav(-) proceeded North to CAISSON 3. 2-2 Infantry(Mech) moved from LAI KHE to and secured CAISSON 4. At 1030 hours, 1-28 Infantry moved to CAISSON 1. 1-4 Cav(-) then proceeded to CAISSON 3. Additionally commencing at 1200 hours, 1-16 Infantry moved VIA F/W aircraft to QUAN LOI. Both units closed by 1555 hours.

The second day of the operation found the IRON Brigade continuing to position units and clear HWY 13 from CHAN THANH to QUAN LOI. At 0630 hours, 1-4 Cav(-) moved to and secured LZ JOE (XT788681). Simultaneously 1-28 Infantry secured CAISSON 2 and escorted artillery units into that position. At 0930 hours, 1-26 Infantry moved from QUAN LOI to LZ JOE. One troop 1-4 Cav(-) secured LZ ED. At 1300 hours, 2-16 Infantry moved to and secured LZ ED(XT766757) and LZ MACK (XT769786). Trp 1-4 Cav(-) then moved and became attached to CAISSON 2.

(b) PHASE II. During this phase of the operation the 3d Brigade cleared and secured HWY 13 in sector on a daily bases by 0900 hours, and controlled convoy movements from LAI KHE to QUAN LOI. On 3 July 1967. The resupply convoy progressed through the 3d Brigade sector to QUAN LOI without incident. During road clearing operation however, 1-16 Infantry had 1 WHA when an individual stepped on a mine (XT793434). Additionally, in the 2-16 Infantry area, one US soldier was WHA when two RPG rounds were fired into the area. On 4 July 1967. The road from QUAN LOI to LAI KHE was cleared by 0843 hours without incident also the resupply convoy cleared the 3d Brigade sector without incident.

CONFIDENTIAL

CONFIDENTIAL

On 5 July 1967, again the road was cleared and secured and the convoy moved to QUAN LOI without incident. On 6 July 1967, the road was cleared by 0855 hours. At 0702 hours (via XT767760), a tank from G/4 Cav was hit by an RPG round. The tank was destroyed and 5 US personnel were WIA. The convoy progressed South without incident.

(c). PHASE III. During 6-7 July 1967, the IRON Brigade terminated road clearing operations North of LAI KHE, returned attached units to their base camps and continued security of LAI KHE and QUAN LOI without incident.

3. PART III. INTELLIGENCE (ENEMY ORDER OF BATTLE)

a. Enemy activity during the reporting period was characterized by sniping, mortar attacks, recoilless rifle attacks, road blocks, harassing and terrorists attacks. The VC conducted numerous propaganda talks to small groups of people throughout the Brigade TAOR. Major enemy engagements with elements of the 3d Brigade occurred during the period 11 May 1967, and 26 June 1967 during operations MANHATTAN, BLUEFIELD, and BILLINGS. Principal units in the area of interest of the 3d Brigade which could have influenced any battle situation include the following:

- (1). 9th VC Division:
 - (a) 271st Regiment-PHOUC LONG
 - (b) 272d Regiment-BINH LONG
 - (c) 273d Regiment-PHOUC BINH
- (2). 7th NVA Division.
 - (a) 141st Regiment-BINH LONG
 - (b) 165th Regiment-U Loc 3.d.
 - (c) 101st Regiment-Tay Ninh Province
- (3). PHU LOI Battalion: Now considered to be 2 Bns. BINH DUONG Province
- (4). C 61 District Company-BEN CAT District.

b. A brief summary of enemy activity for each of the major operations during the reporting period is presented as follows:

(1). Operation MANHATTAN:

Intelligence indicated that the VC had re-established logistical operations in the area previously penetrated during operation CEDAR FALLS. The 83d Rear services group, subordinate to COSVN and MR IV, was primarily responsible for re-establishing the supply bases and transportation network in the entire area. Political headquarters known to be in the area included MR IV, thru DAU MOT PROVINCE committees, BEN CAT and DAU TIENG District committees, and their subordinates. The 273d VC Regiment was the only known main force unit, reportedly located in the LONG NGUYEN SECRET ZONE, in position to reinforce the enemy if a VC counter sweep was ordered. No major contact was made during the operation, however, there were numerous small unit encounters. Base camps supply depots, rice caches and other food stores were discovered immediately after the operation began. Documents captured in the area confirmed the presence of the 83d Rear services group, security elements of MR IV, and other political headquarters elements. Information gathered from CHIEU HOI's and POW's resulted the discovery of both weapons and ammunition caches. It is believed that the exploitation of hard intelligence developed during Operation MANHATTAN resulted in a complete disruption of the VC logistical base and denied the enemy the use of supplies which could have sustained him for several months in the Western and Central III Corps area.

(2). Operation BLUEFIELD:

a. Agent reports and other intelligence reports indicated tax collection points along HWY 13 and movement of the 273d VC Regiment and small groups, company and squad size, entering and departing the area daily. The area of this operation extended approximately 12 KM North and 13 KM East, Northeast of LAI KHE bounded by coordinates XT7440, XT7454 and East to the SONG BE River. Political elements considered to be in this area were thru DAU MOT, LONG BINH province, BEN CAT District, and CHOU THANH District committees and their subordinate elements.

CONFIDENTIAL

61

CONFIDENTIAL

b. During this operation many base camps, some recently constructed and some old and not recently used were located. Many of them had overhead cover on bunkers and communication tunnel systems. Some structures had reinforced steel and concrete supports. Hot food and hot ashes discovered in some of the areas indicated the enemy had recently occupied the area. Friendly elements did not engage any VC units but received some sniper fire. A large number of booby traps ranging from homemade hand grenades to 155 MM rounds were found throughout the area. A total of 24 weapons were captured, some homemade, others appeared in the stage of repair, along with powder, primers, cartridge cases, and gunsmith tools. The size and type structures discovered indicate the area to be possible 'secure' area used by the VC for retraining and refitting elements of 273d Regiment, and possibly other elements of the 9th VC Division.

c. Base camps, fortifications, tunnels, and other structures were, in most cases, well constructed with overhead cover, good camouflage, and strategically located. Most significant discoveries were as follows:

Vic XT872458:	(1) 12 Bunkers W/OH Cover
Vic XT836482:	(2) 100 foxholes-
Vic XT863475:	(3) 5 huts & 300 meters of trench
Vic XT893481:	(4) 25-30 Bunkers
Vic XT865477:	(5) 20 Bunkers
Vic XT877468:	(6) 300 meters tunnel leading off in several directions and large enough to walk in.
Vic XT870449:	(7) 15 huts

d. Terrain in the area is generally flat with broad leaf ever-green forest, intermingled with bushes and bamboo forest in the NE corner. The area along route 13 had been defoliated in many places, however, the double type canopy still hides most of the ground throughout the remainder of the area. Weather was characterized by occasional rain and did not impede the operation.

(3). Operation BILLINGS:

The area of operation was bounded by following coordinates: XT8245, XT8278, XT1178, and YT1145. The area is dominated by secondary forest with considerable wet land rice area along the numerous streams scattered throughout the area. Intelligence reports indicated that large and numerous VC base camps, tunnels, food storage area, fortified positions and other allied installations, with heavy concentrations of installations in the SW and SE quarter of the area. In addition to the 271st VC Regiment, reportedly there would also be MRI Hqs, THU DAU DOT, and BINH LONG Province committees and TAN UYEN, BEN CAT, and CHON THANH District committees and their subordinate elements.

It was discovered that the area contained numerous large base camps. At the onset only sniper fire was received by friendly units from harassing elements and caretaker units in base camps. The VC defended their position throughout the area. The first major engagement took place on 14 June 1967 when B 1-16 engaged an estimated VC company vicinity XT937669 believed to be a unit of the 1st Bn, 271st VC Regiment. The VC were dressed in KHAMBI uniforms and employed mortars, MM/SA, M-79's, MG and hand grenades. There were 60 VC KIA(BC) and light casualties to friendly troops. On 17 June 1967, vic XT958675 elements of the 1st & 2d Bn 271st VC Regiment attacked the 1-16 Infantry and 2-28 Infantry. The attack was launched with two assaults from the front and one from the West flank. VC losses were, 196 KIA(BC) with heavy friendly casualties. The VC were successful in evacuating their dead and wounded along with their weapons in spite of heavy friendly artillery fire into the battle area. A PW confirmed the attacking VC unit as the 2d Bn, 271st VC Regiment. During the ensuing days, many dead VC were found (minus weapons). Some were found in groups, others in hastily built graves. Weapons captured during the operation were in excellent condition, as was the web equipment. On 19 June 1967, B 1-18 Infantry entered a VC base camp vic XT951693 and found 35 dead VC, 53 bunkers with overhead cover, new camouflage, and latrines, along with many parts of bloody clothing and some medicine. This base camp probably had been used as an aid station or hospital and as a result of an airstrike, additional VC were killed and the wounded carried off.

The operational area was mostly flat with heavy jungle undergrowth and in many places double canopy jungle. This area offered excellent concealment from the air and was found to be extremely difficult in spotting base camps from the air and making accurate EDA, except where direct hits were made.

CONFIDENTIAL

56

62

CONFIDENTIAL

and opened up the target. Weather during the first week of the operation was heavy rain fall, which did not hamper ground operations, but did cause aircraft to operate under the most extreme conditions. Base camps throughout the area were well constructed, reinforced, and camouflaged. Food and equipment caches were not found, however many supply sampans along the SONG BE River were destroyed. No civilian personnel were encountered by friendly elements during the course of the operation.

4. PART IV PERSONNEL:

a. Strength:

- (1) Authorized: Officers: 134 WO: 12 EM: 2554
- (2) Assigned: as of 31 May - Officers 126 WO 10 EM 2954
as of 30 Jun - Officers 121 WO 8 EM 2735
as of 31 Jul - Officers 118 WO 5 EM 2458
- (3) Replacements gained during the period 1 May to 31 July - 761.
- (4) Hospital returns during the period 1 May to 31 July - 158.
- (5) Other troops authorized and assigned during the period: one (1) Liaison officer (ARVN), one (1) liaison NCO (ARVN) and twelve (12) interpreters (ARVN).

b. Replacements: Presently this unit is short 16 officers, 7 warrant officers and 110 enlisted men. All newly assigned EM in the grade E-7 and below and officers in grade O-1 and O-2 attend the "combat Indoctrination Course" conducted by the brigade S-3. At the present time there is an acute shortage of Captains and enlisted personnel in the grade of E5 within the Brigade.

c. Discipline: During the period 1 May through 31 July 1967 one (1) enlisted man was tried by Summary Court Martial, twenty (20) enlisted men were tried by Special Court Martial and two (2) enlisted men were tried by General Courts Martial.

d. Prisoners of War: Four (4) VCS and Six (6) VC were processed through US and ARVN channels. Three (3) ralliers were returned to government control.

e. Burials and Graves Registration: None.

f. Civil Assistance:

(1) PSYCHOLOGICAL OPERATIONS: During the quarter, May, June and July a total of twenty-two (22) leaflet drop missions were conducted, which accounted for a total of 2,307,000 leaflets being dropped. Other PSY/OPS missions accounted for a total of fifty-five (55) hours of loudspeaker missions. The majority of the leaflets used were, Chieu Hoi, Safe Conduct Passes, Good Points of (GVN), Return to Family, Rally Instructions, and Power. All PSY/OPS missions were coordinated with the Brigade S2.

(2) CIVIC ACTION:

a. During the quarter a total of 152 tons of rice was issued. Twenty (20) tons was distributed to the Ben Cat Subsector for subsequent issue to the refugees of the Ben Cat Refugee Center. Additionally, nine (9) tons of rice was given to the 5th ARVN Division Mobil Training Team to assist them in their pacification efforts. Also, 120 tons of rice was given to the 1st Infantry Division G5 for issue to the refugees in the Di An area. Other commodity issues included 350 sewing kits, 100 white "T" shirts, candy, flats, and over seven (7) tons of canned food items, which consisted of:

- | | |
|------------------------|-------------------------|
| (1). Evaporated Milk | (11). Whole Milk |
| (2). Powder Milk | (12). Cereal |
| (3). Dehydrated Apples | (13). Granulated Sugar |
| (4). Cornmeal Beef | (14). Frankfurters |
| (5). Flour | (15). Dehydrated Prunes |
| (6). Powder Desert | (16). Jam |
| (7). Cornmeal | (17). Cold Water Starch |
| (8). Dehydrated Soup | (18). Brown Sugar |
| (9). Peanut Butter | (19). Margarine |
| (10). Shortening | (20). Coffee |

CONFIDENTIAL

63

CONFIDENTIAL

b. Support and technical assistance is still being provided to the BEN CAT subsector for construction of refugee houses in the BEN CAT area. Currently, approximately 150 houses have been completed in the BEN CUY center. Other than technical advice, the 3d Brigade no longer participates in this project, which is now the primary responsibility of the MACV Advisory Team and USAID. Construction of a village theater for LAI KHE village will begin as soon as required materials are available. Plans have been drawn and a request for materials has been submitted to the 1st Infantry Division G5. To this date no materials have been provided and G5 has given absolutely no indication as to when any support can be expected. Operation of the brick factory has been extremely limited due to adverse weather conditions. During the quarter 4450 Cinva-Ram blocks, which will be used in theater construction, were produced. Additionally "C" Company, 1st Engineer Battalion repaired a culvert about one (1) Kilometer South of BEN CAT on Highway # 13.

c. During the quarter 6380 people received treatment under the MEDCAP program. Most serious cases treated included malaria.

d. One (1) Solutium Payment was made during the quarter.

g. Morale and personnel Services: Morale of the Brigade continues to be high. 2 Congressional Medals of Honor, 1 Distinguished Service Cross, 30 Silver Stars, 2 Soldier's Medals, 6 Distinguished Flying Crosses, 9 Legions of Merit, 133 Bronze Stars (Valor), 272 Bronze Stars (Merit), 87 Army Commendation Medals (Valor), 161 Army Commendation Medals (Merit), 5 Air Medals (Valor) and 110 Air Medals have been recommended for awarding to members of the Brigade. At the Red Cross Recreation Center a basketball and a volley ball court has been constructed for the enjoyment of the troops. The LAI KHE Base swimming Pool has been renovated and reopened for the use of all personnel at LAI KHE Base. Radio LAI KHE continues to operate from 1200-2400 hours daily for entertainment of the troop garrisoned at LAI KHE. Very fine ARC support is available at all times. Chapel attendance is high and all units have assigned chaplains.

h. Personnel Management: Assignment of newly arrived replacements has been altered whenever necessary to allow an equalization in the redistribution of personnel within the battalions normally attached to this headquarters. One main problem is the non receipt of reassignment instructions for senior enlisted personnel until 10-15 days prior to DEPOS and in some cases none at all causing those personnel to return to CONUS on an unassigned basis. There is also the problem of no replacements for senior noncommissioned officers arriving prior to the departure of the present incumbents.

i. Civilian Employment:

(1). 974 Vietnamese personnel are employed within the base perimeter and Engineers.
 (a) 250 are employed by the firm of Pacific Architects
 (b) 169 are employed by concessions, clubs, or individuals

(2). Additionally there are 35 Koreans, 15 Filipinos and 9 US citizens employed within the base camp.

5. PART V LOGISTICS:

a. The majority of operations during the reporting period were resupplied from the LAI KHE Base. On two occasions (CHI LINH & QUAN LOI) a forward supply base was established near the operations area. The majority of resupply was effected by helicopter, although resupply by road was used. No significant problems were encountered.

b. SUPPLY:

(1) Supported strength:	4700 average.	
(2) Supply levels	AUTH	on hand
(a) Class I	155	15
(b) Class II & III	draw as needed	
(c) Class V	3 Days	3 Days +
(d) Class III		
JPA	80,000	60,000
AVGAS	10,000	15,000
MOGAS	65,000	65,000
DIESEL	75,000	60,000

CONFIDENTIAL

64

CONFIDENTIAL

(e) Items in short supply: 8' pickets, generators, front end loaders, tin electrical wiring, bull dozers, new M-16 buffer assembly, M-16 magazines, cleaning rods, bore brushes, tires for all vehicles, brake shoes & carburetors for 1/4 M151 trucks.

(3) Local procurement: None

c. EVACUATION:

(1) Casualties:

(a) From hostile action. 206
(b) Disease. 5,571
(c) Injury. 331

(2) Prisoners of War:

(3) Refugees: None

d. TRANSPORTATION:

(1) Highway-6,000 tons of cargo were moved to LAI KHE over Highway 13. Minor repairs were required to keep the road in a passable condition.

(2) Air: 2800 tons of cargo were airlifted into LAI KHE.

e. SERVICE:

(1) Maintenance: The direct support ordnance unit has been able to keep abreast of maintenance problems in the vehicle category. Signal equipment is evacuated because of lack of personnel or test equipment which is required to repair the equipment.

(2) Construction: Approximately 68% of the currently approved base plan has been completed.

(3) Miscellaneous: N/A

6. PART VI CHRONOLOGY

11 MAY 1967	Operation	MANHATTAN	Terminated.
5 JUN 1967	Operation	BLUEFIELD	Commenced.
9 JUN 1967	Operation	BLUEFIELD	Terminated.
11 JUN 1967	Operation	BILLINGS	Commenced.
21 JUN 1967	Operation	BILLINGS	Terminated.
1 JUL 1967	ROAD CLEARING	OPN	Commenced.
7 JUL 1967	ROAD CLEARING	OPN	Terminated.

7. PART VII DISCUSSION and RECOMMENDATION

a. Lessons Learned.

(1) OPERATION MANHATTAN:

a. The VC would not stand and fight but employed harassing tactics, using snipers and booby traps extensively. By effective use of Artillery and air support the IRON Brigade was able to push through VC bases with minimum casualties.

b. On two occasions several US personnel were wounded by one booby trap. The continued need for emphasis on dispersion is still evident. Leaders at all levels must adhere to the basic principles of ground combat. These basic tactics save more lives in jungle fighting than the finest strategy or most cunning tactics.

c. When conducting search and destroy operation in jungle area or heavy VC population. Plans must be flexible and time schedules tentative. When a base camp is discovered, it must be thoroughly searched.

d. The use of information provided by a CHIEU HOI proved to be very valuable. Information of this type should be thoroughly exploited.

(2) Operation BLUEFIELD: None

(3) Operation BILLINGS: This operation proved that US Forces can operate successfully in areas previously considered as "Safe Haven" for the VC. Heavy losses of the VC on his own ground can and will greatly reduce his efficiency and weaken his will to resist.

CONFIDENTIAL

65

CONFIDENTIAL

b. Operational plans should include sufficient time for contingencies. There should be ample time to carefully search and destroy base camps and tunnel complexes and dispose of large supply cache discovered during the operation.

FOR THE COMMANDER:

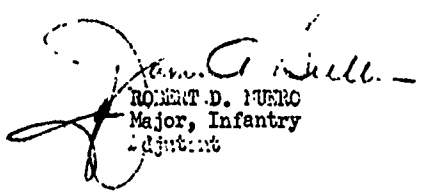
ROBERT D. FUERO
Major, Infantry
Adjutant

CONFIDENTIAL

67

DEPARTMENT OF THE ARMY
HEADQUARTERS 1ST ENGINEER BATTALION
APO 96345

AVDB-CE-3

4 August 1967

SUBJECT: Quarterly Operational Lessons Learned Report

TO: Commanding General
1st Infantry Division
ATTN: AVDB-T
APO 96345

1. Introduction: The following is a summary of lessons learned, methods used, and new concepts developed by the 1st Engineer Battalion during the period 16 May 67 - 28 July 67.

2. Road Repair: During Operation MANHATTAN, this unit noted that often a heavy vehicle would break through the laterite crust of a weak section in a road. To build up weak sections or to cover holes, this unit placed the super structure of timber trestle bridges over such areas. This super structure normally includes footers, stringers of a minimal size, decking and treadway.

Observation: This technique may be the most practical when heavy traffic is imminent, time and equipment are not available, and the road sections to be repaired are not large. However, it is costly in terms of material expended.

3. Road Construction Prior To Convoy Movement: Recently it has been noted that in future operations it may be practical to deploy an engineer work force to construct and repair roads before the start of convoy operations. During recent operations, engineers have been given time to repair and reinforce bridges and to make road reconnaissances, but actual road rehabilitation has not begun until the convoy commenced. The convoy traffic not only reduces the efficiency of the engineers, but impairs the repair effort slowing convoy movement.

Observation: If an engineer work force could be deployed to construct or repair roads prior to convoy operations, this would not only enable faster convoy traffic, but also release engineers for other support missions during the convoy.

SUBJECT: Quarterly Operational Lessons Learned Report

4. Tank Dozer Deployment: Although the tank dozer is not as effective in clearing operations as the bulldozer there are certain advantages in using the tank dozer that make it more practical to use than the bulldozer in areas that may contain VC. When working with the Rome plows, the tank dozer can do the same job as the bulldozer, thereby releasing the bulldozer for other engineer work. At the same time, the tank dozer provides mobil security and increased available firepower during the land clearing operations. Also the tank dozer gives more confidence to the Rome plow operators, as its presence has a negative effect on VC snipers.

Observation: Deployment of tank dozers in land clearing operations not only provides mobil security, but also permits use of bulldozers on other engineer tasks. Provisions should also be made for other security to include APC's and tanks.

5. Landing Zone Clearing Kits: In recent operations two facts have been noted that have increased the efficiency of the LZ clearing teams. First, in areas containing trees of diameter larger than 35 inches, it is often faster to use the two man cross cut saw. This is because it is very difficult to cut trees of this size with chain saws and the use of demolitions is often not desirable due to size of charge and the resultant continual movement of men and equipment away from the blasting area. Second, on several LZ clearing missions an excess of equipment was carried creating transportation problems. It has been found that good reconnaissance of LZ areas will eliminate unnecessary equipment.

Observation: A good reconnaissance of the proposed LZ location should assist in choosing the correct equipment and eliminate taking unnecessary equipment.

6. Use of Cruiser Chain For Land Clearing: Land clearing operations utilizing D7 dozers and cruiser chain were conducted in June 67 in areas surrounding Di An Base Camp. This method was found ineffective in these areas due to the type of vegetation present, i.e. secondary jungle of thick undergrowth and small trees. The cruiser chain would ride up and over the brush, the majority of which would spring back up within a few days.

This method was again tried during Operation PAUL PUNYON in the Ong Dong jungle area. Using 180 feet of cruiser chain between two D7E's proved effective in clearing rubber trees, two rows at a time. The land clearing production rate was not found to vary substantially from that of two D7E Rome plows.

Information received from the 65th Engr Bn, 25th Division indicates that the use of M88 VTR's pulling 270 to 360 feet of chain would increase the production rate considerably, the reported rate: up to 28 acres of rubber trees per hour. This latter method will be attempted as M88's can be made available.

69

AVDB-CE-3

SUBJECT: Quarterly Operational Lessons Learned Report

L. Aug 67

Observation: In rubber tree land clearing operations, D7E's with cruiser chains can be utilized as effectively as D7E Rome plows, thus freeing the Rome plows for clearing of both primary and secondary jungle areas, where they are particularly effective.

FOR THE COMMANDER:

Stanley G. Geneva
STANLEY G GENEVA
1LT, GE
Adjutant

64

3

71

CONFIDENTIAL

DEPARTMENT OF THE ARMY
HEADQUARTERS 1ST INFANTRY DIVISION
Office of the Chemical Officer
APO 96345

AVDB-CM

31 July 1967

SUBJECT: Operational Report on Activities and Lessons Learned (U)

1. (U) Reporting period: 1 May 1967 to 31 July 1967.

2. (C) Listed below are the activities of the Division Chemical Section during the reporting period 1 May 1967 to 31 July 1967.

a. 3 May 1967 - A Division Chemical Section Manpack Personnel Detector Team conducted a search in the vicinity of QUAN LOI. Two (2) hot spots were identified and fired on by the accompanying gun ships, after which an aerial observer directed artillery on the hot spots. Before the effects could be assessed, the light fire team was called away on a tactical emergency. The Division Tunnel Team departed DI AN helipad to assist the 1/2 Infantry in the exploration of a reported tunnel complex. The team explored one (1) tunnel approximately 200 meters in length. No enemy personnel or equipment were found.

b. 5 May 1967 - A Division Chemical Section MPD Team conducted a search in the PHUOC VINH and QUAN LOI areas. Seven (7) hot spots were identified and reported to G2 Air and Division Artillery for the planning of fires.

c. 6 May 1967 - A Division Chemical Section MPD Team conducted a search northeast of PHUOC VINH. Sixteen (16) hot spots were identified and reported to G2 Air and Division Artillery for the planning of fires. The Division Tunnel Team assisted the 1/26 Infantry in the exploration of a well. No enemy personnel or equipment were found.

d. 7 May 1967 - A Division Chemical Section MPD Team conducted a search north of PHUOC VINH. Twenty-five (25) hot spots were identified and reported to G2 Air and Division Artillery for the planning of fires.

e. 10 May 1967 - A Division Chemical Section MPU Team conducted a search north of QUAN LOI. Ten (10) hot spots were identified upon which an aerial observer directed eight inch howitzer fire. Results unknown.

DOWNGRADED AT 3 YEAR INTERVALS
DECLASSIFIED AFTER 12 YEARS
DOD DIR 5200.10

65
CONFIDENTIAL

CONFIDENTIAL

72

AVDB-CM

31 July 1967

SUBJECT: Operational Report on Activities and Lessons Learned (U)

f. 12 May 1967 - A Division Chemical Section MPD Team conducted a search in two (2) areas: one northeast of QUAN LOI where three (3) hot spots were identified and one north of MINH THANH where two (2) hot spots were identified. The hot spots were reported to the 1st Bde for the planning of fires.

g. 13 May 1967 - A Division Chemical Section CS Drop Team departed DI AN via two (2) CH-47 aircraft for a CS target from XT934650 to XT947655. Sixty (60) drums of CS-1 were placed on target. The team flew to PHUOC VINH and reloaded and refueled. The team then dropped 50 drums of CS-1 from coordinates XT927657 to XT941671.

h. 15 May 1967 - The Division Chemical Section started a wet season CS persistency test outside of the DI AN Base Camp. Three (3) 55 gal drums filled with CS-1 were detonated under conditions similar to those in aircraft drops. One (1) drum was suspended in a tree five (5) meters above the ground. The remaining two were detonated on the ground: one in the jungle area, the other in an open area. A separate report is being prepared on the results of this test.

i. 20 May 1967 - A Division Chemical Section MPD Team conducted a search west and northeast of PHUOC VINH. Thirty-five (35) hot spots were identified and reported to G2 Air for the planning of fires.

j. 21 May 1967 - A Division Chemical Section MPD Team conducted a search east of the SONG BE River. Four (4) hot spots were identified and reported to G2 Air for targeting.

k. 22 May 1967 - A Division Chemical Section MPD Team conducted a search west and north of PHUOC VINH. Five (5) hot spots were identified and reported to G2 Air for the planning of fires. The Division Tunnel Team moved to coordinates XT930230 to assist the 2/2 Infantry in exploring a reported tunnel complex. Upon arrival, the team discovered no tunnels; however, seven (7) bunkers were explored with negative results.

l. 24 May 1967 - A Division Chemical Section MPD Team conducted a search north and east of PHUOC VINH. Twenty-four (24) hot spots were identified and reported to Division Artillery and 1st Brigade for the planning of fires.

m. 25 May 1967 - A Division Chemical Section MPD Team conducted a search north and east of PHUOC VINH. Four (4) hot spots were identified and reported to Division Artillery and the 1st Brigade for the planning of fires.

66

CONFIDENTIAL

23

CONFIDENTIAL

AVDB-CM

31 July 1967

SUBJECT: Operational Report on Activities and Lessons Learned (U)

n. 26 May 1967 - A Division Chemical Section MPD Team conducted a search north of BIEN HOA. Fifteen (15) hot spots were identified and reported to Division Artillery for the planning of fires.

o. 27 May 1967 - A Division Chemical Section MPD Team conducted a search north and east of PHUOC VINH. Twenty-nine (29) hot spots were identified and reported to Division Artillery for the planning of fires. A search north of BIEN HOA yielded negative results.

p. 28 May 1967 - A Division Chemical Section MPD Team conducted a search north of BIEN HOA. Four (4) hot spots were identified and reported to G2 Air for the planning of fires.

q. 30 May 1967 - A Division Chemical Section MPD Team conducted a search north and east of PHUOC VINH. Sixteen (16) hot spots were identified and reported to the 1st and 2d Brigades for the planning of fires.

r. 1 June 1967 - A Division Chemical Section MPD Team conducted a search north and northeast of PHUOC VINH. Thirteen (13) hot spots were identified and reported to G2 Air for the planning of fires.

s. 2 June 1967 - A Division Chemical Section MPD Team conducted a search north and northeast of PHUOC VINH. Ten (10) hot spots were identified and reported to G2 Air for the planning of fires.

t. 3 June 1967 - A Division Chemical Section MPD team conducted a search north and northwest of PHUOC VINH. Three (3) hot spots were identified and reported to G2 Air for the planning of fires.

u. 4 June 1967 - A Division Chemical Section MPD team conducted a search north and northeast of PHUOC VINH. Nine (9) hot spots were identified and reported to G2 Air for the planning of fires. An NCO from the 242d Chemical Detachment was trained by the 79th Maintenance Battalion in the maintenance of the Manpack Personnel Detector, E63. Instructions which were coordinated through the ~~the~~ were issued to divisional units using the MPD. The instructions stated that maintenance and supply for the instrument would be coordinated through the Division Chemical Section.

v. 5 June 1967 - The Division Chemical Section checked the wet season CS persistency test outside of the DI AN Base Camp (see item 2h).

CONFIDENTIAL

67

CONFIDENTIAL

74

AVDB-CM

31 July 1967

SUBJECT: Operational Report on Activities and Lessons Learned (U)

w. 6 June 1967 - A Division Chemical Section MPD Team conducted a search around PHUOC VINH. Fourteen (14) hot spots were identified and reported to G2 Air for the planning of fires.

x. 7 June 1967 - A Division Chemical Section MPD Team conducted a search around PHUOC VINH. Three (3) MPD trainees from 1st Brigade were given in-flight training on the MPD during the mission. Eight (8) hot spots were identified and reported to G2 Air for the planning of fires.

y. 8 June 1967 - A Division Chemical Section MPD Team assisted by three trainees from the 1st Brigade, conducted a search north and south of PHUOC VINH. No hot spots were identified. 1st Brigade trainees were released at PHUOC VINH. Five (5) XM-27 and 15 ea XM-28 RCA masks were issued to the 1st Brigade for testing. A Division Chemical Section CS Drop Team conducted a CS drop on two targets. The first a line from XT856607 to XT863599; the second a line from XT864604 to XT868604. Thirty (30) drums of CS-1 were dropped on both targets.

z. 9 June 1967 - The Division Chemical Section established its forward office at LAI KHE. A representative of the section started MPD operations and maintenance training with D Trp 1/4 Cavalry at PHU LOI. A Division Chemical Section MPD Team conducted a search north of PHUOC VINH. One (1) hot spot was identified and reported to G2 Air for the planning of fires. A Division Chemical Section CS Drop Team conducted a CS drop on two targets. Target one was a line between YT074426, YT083427, and YT083436. Target two was a line between YT086427, YT090434, and YT087437. Thirty (30) drums were dropped on each target.

aa. 10 June 1967 - A Division Chemical Section MPD Team conducted a search northwest of PHUOC VINH. Seven (7) hot spots were identified and reported to G2 Air for the planning of fires. At the time of detecting a hot spot vicinity XT893622, the detector ship received an unknown number of SA rds from 4 VC. The aircraft received 1 hit in the main rotor blade, but continued to PHUOC VINH. The light fire team engaged the 4 VC with undetermined results.

bb. 11 June 1967 - A Division Chemical Section MPD Team conducted a search west of PHUOC VINH. Seven (7) hot spots were identified and reported to G2 Air for the planning of fires.

cc. 12 June 1967 - A Division Chemical Section MPD Team conducted a search around PHUOC VINH. Sixteen (16) hot spots were identified and reported to G2 Air for the planning of fires.

CONFIDENTIAL

68

75
CONFIDENTIAL

AVDB-CM

31 July 1967

SUBJECT: Operational Report on Activities and Lessons Learned (U)

dd. 13 June 1967 - The Division Chemical Section checked the wet season CS persistency test (see item 2h).

ee. 14 June 1967 - The Division Chemical Section dispatched one NCO to 1/4 Cavalry to conduct in-flight training on the MPD. A Division Chemical Section MPD Team conducted a search northeast of PHUOC VINH. Ten (10) hot spots were identified and reported to G2 Air for the planning of fires.

ff. 15 June 1967 - A Division Chemical Section MPD Team conducted a search north and south of PHUOC VINH. Ten (10) hot spots were identified and reported to G2 Air for the planning of fires. A Division Chemical Section CS Drop Team departed DI AN at 1730H in two (2) CH-47s for a target from YTO65625 to YTO66606. Sixty (60) drums of CS-1 were dropped on the target.

gg. 16 June 1967 - A Division Chemical Section MPD Team conducted a search north and south of PHUOC VINH, and along the SONG BE River. Twelve (12) hot spots were identified and reported to G2 Air for the planning of fires.

hh. 17 June 1967 - A Division Chemical Section MPD Team conducted a search northeast of PHUOC VINH. Two (2) hot spots were identified and reported to G2 Air for the planning of fires.

ii. 18 June 1967 - A Division Chemical Section MPD Team conducted a search north of PHUOC VINH. Seven (7) hot spots were identified and reported to G2 Air for the planning of fires. The Division Chemical Officer made an on the spot investigation of the reported use of riot control agents against A Company, 1/16 Infantry, during a battle on 17 June 1967. Investigation indicated that RCA was used twice - once during the initial SA attack and once during the mortar attack. Type of dispersion media was unknown.

jj. 19 June 1967 - A Division Chemical Section MPD Team conducted a search north of PHUOC VINH. Twenty-two (22) hot spots were identified and reported to G2 Air for the planning of fires.

kk. 20 June 1967 - A Division Chemical Section MPD Team conducted a search north of PHUOC VINH. Sixty-four (64) hot spots were identified and reported to G2 Air for the planning of fires.

ll. 21 June 1967 - The Division Chemical Section conducted operation and maintenance training on the MPD for three individuals from

CONFIDENTIAL

69

CONFIDENTIAL

76

AVDB-CM

31 July 1967

SUBJECT: Operational Report on Activities and Lessons Learned (U)

the Pathfinder Detachment of the 11th Aviation Battalion and one individual from the 25th Infantry Division. A Division Chemical Section MPD Team conducted a search north of PHUOC VINH. The team was accompanied by 3 members of the 25th Infantry Division Chemical Section who received in-flight training on the MPD. Twenty (20) hot spots were identified and reported to G2 Air for the planning of fires.

mm. 22 June 1967 - An NCO from the Division Chemical Section conducted MPD in-flight training for 1/4 Cavalry at PHU LOI. A Division Chemical Section MPD Team conducted a search north of PHUOC VINH. Fifty (50) hot spots were identified and reported to G2 Air for the planning of fires.

nn. 23 June 1967 - A Division Chemical Section MPD Team conducted a search north of PHUOC VINH astride Highway 13. Twenty (20) hot spots were identified and were reported to G2 Air for the planning of fires.

oo. 24 June 1967 - A Division Chemical Section MPD Team conducted a search north of Highway 13 west of DONG XOAI. Fourteen (14) hot spots were identified and reported to G2 Air for the planning of fires.

pp. 25 June 1967 - A Division Chemical Section MPD Team conducted a search north of Highway 13. Twenty-nine (29) hot spots were identified and reported to G2 Air for the planning of fires. A Division Chemical Section CS Drop Team departed DI AN for a line target from XT927657 to XT943653. Sixty (60) drums of CS-1 were dropped on target, with good coverage.

qq. 26 June 1967 - A Division Chemical Section MPD Team conducted a search south of PHUOC VINH. Four (4) hot spots were identified and reported to G2 Air for the planning of fires. The Division Chemical Section checked the wet season CS persistency test outside of DI AN Base Camp. CS was still present in the area (see item 2h).

rr. 28 June 1967 - The Division Chemical Section furnished 1 NCO who assisted an 11th Aviation Battalion MPD Team in conducting a search in support of the 1st Infantry Division. Eighteen (18) hot spots were identified and reported to G2 Air for the planning of fires.

ss. 29 June 1967 - A Division Chemical Section CS Drop Team departed DI AN via one (1) CH-47 for a target from XT903639 to XT904645. The team dropped 26 drums of CS-1 on target. The drop was made using a newly fabricated CS drum rack. The new rack proved vastly superior to the old system. (See Lessons Learned.)

CONFIDENTIAL

70

77

CONFIDENTIAL

AVDB-CM

31 July 1967

SUBJECT: Operational Report on Activities and Lessons Learned (U)

tt. 30 June 1967 - A Division Chemical Section MPD Team conducted a search between Highway 13 and the SONG BE River, north of LAI KHE. Eight (8) hot spots were identified and reported to G2 Air for the planning of fires. A Division Chemical Section CS Drop Team departed DI AN in two (2) CH-47s for a CS target from XT866602 to XT870307. The target was successfully covered with 60 drums of CS-1.

uu. 1 July 1967 - A Division Chemical Section MPD Team conducted a search north of LAI KHE and east of Highway 13. Thirty-seven (37) hot spots were identified and reported to G2 Air for the planning of fires. A Division Chemical Section CS Drop Team departed DI AN in two (2) CH-47s for two (2) CS targets northwest of PHUOC VINH at XT867590 and XT855584. Thirty (30) drums of CS-1 were dropped on each target.

vv. 2 July 1967 - A Division Chemical Section MPD Team conducted a search north of LAI KHE and east of Highway 13. Eighteen (18) hot spots were identified and reported to G2 Air for the planning of fires. A Division Chemical Section CS Drop Team departed DI AN in one (1) CH-47 for a CS target located at XT916657. Target was a well-used river crossing. Thirty (30) drums of CS-1 were dropped on the target. LTC J. K. Stoner, Jr., reported into the 1st Infantry Division as the newly assigned Chemical Officer.

ww. 3 July 1967 - A Division Chemical Section MPD Team conducted a search north of LAI KHE and east of Highway 13. Thirty-three (33) hot spots were identified and reported to G2 Air for the planning of fires.

xx. 4 July 1967 - A Division Chemical Section MPD Team conducted a search north of LAI KHE, west of Highway 13, and just east of the MINH THANH plantation. Thirteen (13) hot spots were identified and reported to G2 Air for the planning of fires.

yy. 6 July 1967 - A Division Chemical Section MPD Team conducted a search north of BIEN HOA. Eighty-seven (87) hot spots were identified and reported to G2 Air for the planning of fires.

zz. 7 July 1967 - A Division Chemical Section CS Drop Team departed DI AN in one (1) CH-47 for a CS target southeast of CHI LINH (XT9273). The target, from XT956706 to XT955702, was successfully covered with 30 drums of CS-1.

aaa. 8 July 1967 - A Division Chemical Section MPD Team conducted a search northeast of PHUOC VINH. Ten (10) hot spots were identified and reported to G2 Air for the planning of fires. LTC J. K. Stoner, Jr., assumed the responsibilities of Division Chemical Officer, vice LTC A. R. Hylton.

CONFIDENTIAL

71

CONFIDENTIAL

18

AVDB-CM

31 July 1967

SUBJECT: Operational Report on Activities and Lessons Learned (U)

bbb. 9 July 1967 - A Division Chemical Section MPD Team conducted a search northeast of TAN UYEN. One (1) hot spot was identified and reported to G2 Air for the planning of fires. A Division Chemical Section CS Drop Team departed DI AN in one (1) CH-47 for a CS target between XT975703 and XT980702. Thirty (30) drums of CS-1 were dropped on the target with good coverage.

ccc. 10 July 1967 - A Division Chemical Section MPD Team conducted a search south of the SONG BE River and northeast of TAN UYEN. Seven (7) hot spots were identified and reported to G2 Air for the planning of fires. The detector aircraft received 2 - 3 rds of SA fire from vicinity of YT114343, with no casualties or damage. Fire was returned with undetermined results.

ddd. 13 July 1967 - A Division Chemical Section MPD Team conducted a search south of the SONG BE River and northeast of TAN UYEN. Twenty nine (29) hot spots were identified and reported to G2 Air for the planning of fires. LTC A. R. Hylton departed 1st Infantry Division on DEROS.

eee. 14 July 1967 - A Division Chemical Section MPD Team conducted a search vicinity of QUAN LOI. Fifteen (15) hot spots were identified and reported to G2 Air for the planning of fires. A Division Chemical Section CS Drop Team departed DI AN in two (2) CH-47s for seven (7) CS point targets at XT656417, XT665410, XT625432, XT622450, XT613432, XT625438, and XT628412.

fff. 15 July 1967 - A Division Chemical Section MPD Team conducted a search north and east of QUAN LOI. Four (4) hot spots were identified and reported to G2 Air and the 3rd Brigade for the planning of fires. The detector aircraft, covered by the accompanying light fire team, picked up a wounded Vietnamese individual at XT670853. The man was armed with an M-1 rifle, and wore a "tiger suit" with red and blue scarf. The individual was turned over to the 3rd Brigade for processing. A Division Chemical Section CS Drop Team departed DI AN in two (2) CH-47s for a line CS target from YT106444 to YT107458. Sixty (60) drums of CS-1 were dropped on the target. 1st Brigade at PHUOC VINH reported a low concentration of CS from 1911H to 1935H. Wind shifts at 1000, 2000, and 4000 foot levels resulting from severe thunderstorms blew CS-1 from the target into PHUOC VINH.

ggg. 16 July 1967 - A Division Chemical Section CS Drop Team departed DI AN in one (1) CH-47 for a CS target at YT092468. Thirty (30) drums of CS-1 were dropped on the target.

CONFIDENTIAL

72

77

CONFIDENTIAL

AVDB-CM

31 July 1967

SUBJECT: Operational Report on Activities and Lessons Learned (U)

hhh. 17 July 1967 - A Division Chemical Section MPD Team conducted a search north of QUAN LOI. Twelve (12) hot spots were identified and reported to G2 Air and 3rd Brigade for the planning of fires. A Division Chemical Section CS Drop Team departed DI AN in two (2) CH-47s for a target located from XT925345 to XT932331. Only twenty-four (24) drums were dropped due to inclement weather.

iii. 18 July 1967 - A Division Chemical Section MPD Team conducted a search northwest of QUAN LOI. Fifteen (15) hot spots were identified and reported to G2 Air and 3rd Brigade for the planning of fires. A Division Chemical Section CS drop team departed DI AN in one (1) CH-47 for a CS line target from XT858507 to XT862508. Thirty (30) drums of CS-1 were dropped on the target.

jjj. 19 July 1967 - A Division Chemical Section CS Drop Team departed DI AN in one (1) CH-47 for a CS line target from XT935325 following the woodline to XT940323. A radical change in wind direction caused the drop to be postponed.

kkk. 21 July 1967 - A Division Chemical Section MPD Team conducted a search southwest of QUAN LOI. Six (6) hot spots were identified and reported to G2 Air and 3rd Brigade for the planning of fires. A Division Chemical Section CS Drop Team departed DI AN in one (1) CH-47 for a CS target from XT934323 to XT939323. Thirty (30) drums of CS-1 were dropped on the target.

lll. 22 July 1967 - A Division Chemical Section MPD Team conducted a search vicinity of QUAN LOI. Twenty-one hot spots were identified and reported to G2 Air and 3rd Brigade for the planning of fires.

mmm. 23 July 1967 - A Division Chemical Section MPD Team began experimenting with the E63 MPD operating on position number three. On this position the instrument will respond only to people. The Division Chemical Section also began testing with a new fuze/burster combination for CS drum drops.

nnn. 24 July 1967 - The Division Chemical Officer visited the Battalion Commander, 2/28th Infantry, DI AN, to discuss chemical maintenance.

ooo. 25 July 1967 - The Division Chemical Section checked the wet season CS persistency test outside the DI AN Base Camp perimeter (see item 2h).

CONFIDENTIAL

CONFIDENTIAL

80

AVDB-CM

31 July 1967

SUBJECT: Operational Report on Activities and Lessons Learned (U)

ppp. 26 July 1967 - A Division Chemical Section MPD Team, assisted by two trainees from the 3d Brigade, continued a search northeast of TAN UYEN. Two (2) hot spots were identified and reported to G2 Air for the planning of fires. The Division Chemical Section conducted another test of a new fuze/burster combination for CS drum drops. The Division Chemical Officer visited with the Battalion Commander, 2/16 Infantry, DI AN, to discuss chemical maintenance.

qqq. 27 July 1967 - Two (2) individuals from the 2d Infantry Division Chemical Section arrived at DI AN to receive training on the airborne mode E63 MPD from members of the 1st Infantry Division Chemical Section.

rrr. 28 July 1967 - A Division Chemical Section MPD Team assisted by two trainees from the 2d Infantry Division, conducted a search east of AN LOC and east of MINH THANH. Nine (9) hot spots were identified and reported to G2 Air for the planning of fires.

sss. 30 July 1967 - The Division Chemical Section checked the wet season CS persistency test outside of the DI AN Base Camp perimeter (see item 2h). The Division Chemical Officer visited 1/18 Infantry, LAI KHE, and 1/26 Infantry, PHUOC VINH, to discuss chemical maintenance with battalion commanders.

ttt. 31 July 1967 - A Division Chemical Section CS Drop Team departed DI AN in 1 CH-47 for 2 CS targets. Target 1 located from XT863598 to XT863602. Target 2 located from XT871607 to XT868609. All CS drums were equipped with a M10 Destructor/M1A2 15 Sec Delay Detonator fuzing system. Fifteen (15) drums were dropped on each target. One (1) drum fell into the SONG BE River and failed to explode.

3. (U) During the reporting period, LTC Alvin R. Hylton served as the Division Chemical Officer until 8 July 1967. LTC John K. Stoner, Jr., assumed the duties of Division Chemical Officer on 8 July 1967.

4. (C) Listed below are the activities of the 242d Chemical Detachment (CBRC) during the reporting period 1 May 1967 to 31 July 1967.

a. During the reporting period, the detachment was commanded by 1LT Charles P. Barber until 12 July 1967. 2LT Robert D. Montgomery assumed command on 12 July 1967.

b. The Division Tunnel Team responsibility was transferred from the detachment to the 1st Engineer Battalion on 25 May 1967.

CONFIDENTIAL

74

81
CONFIDENTIAL

AVDB-CM

31 July 1967

SUBJECT: Operational Report on Activities and Lessons Learned (U)

c. The detachment processed 1st Infantry Division defoliation requests and monitored the status of defoliation programs of the 1st Infantry Division and those of II Corps which lie within the 1st Infantry Division Area of Responsibility.

d. The detachment provided crew personnel on CS drum drops conducted by the 1st Infantry Division Chemical Section.

e. The detachment provided crew personnel who acted as MPD operators on the Division Chemical Section personnel detection missions.

5. (C) Listed below are the activities of the 266th Chemical Platoon (DS). The platoon was commanded by 1LT Charles Auslander during the period 1 May 1967 to 13 June 1967. 1LT John V. Pittman assumed command of the platoon on 13 June 1967.

a. The platoon had maintenance contact teams at 1st and 3d Brigades of the 1st Infantry Division during the entire reporting period. They have provided the brigades with chemical maintenance, assistance in CS operations, ground based defoliation, and insect control.

b. The platoon has served as the DI AN Base Camp Rapid Reaction Force, and has also conducted Road Runner operations in areas around DI AN Base Camp. On several occasions, the platoon has extracted patrols which have come under fire or become lost. These extractions have been accomplished without incident.

c. The platoon maintained a supply of drums of CS-1 ready for aerial delivery. These drums were requisitioned, prepared with bursters, and held in the platoon storage area for all missions. The platoon also provided the Division Chemical Section with air crew personnel to participate in aerial CS drops on enemy targets.

d. The platoon continued to modify the M4 bursters which are used for CS drops by removing the incendiary mix and substituting Composition C3 in its place. This modification has improved the reliability of the burster, and has reduced the amount of CS that is burned off when the standard incendiary mix is used. A change in this procedure was instituted on 23 July 1967, and is discussed in the Lessons Learned, para 6 of this report.

e. The platoon has provided personnel, equipment, and materials for defoliation missions in support of all 1st Infantry Division base camps during the reporting period.

CONFIDENTIAL

75

CONFIDENTIAL

52

AVDB-CM

31 July 1967

SUBJECT: Operational Report on Activities and Lessons Learned (U)

f. On 15 May 1967, the platoon assisted the Division Chemical Section in initiating a wet season CS persistency test similar in scope to the test for the dry season. Several methods of bursting 55 gal drums of CS and several different jungle conditions were selected for conduct of the tests. A periodic check is being made on its persistency.

g. The platoon has assisted in providing needed items in a civic action project, providing food stuffs to the Selesian Sisters Self Help School located in THU DUC, RVN.

6. (C) Lessons Learned.

ITEM: CS Drum Rack/Conveyor

DISCUSSION: A specially designed rack with roller conveyors was designed and built for use in the CH-47 aircraft for the conduct of CS drops.

OBSERVATION: Prior to design of this system, drums were rolled on the side from the tail of the CH-47. This technique was both awkward and dangerous. Use of the rack/conveyor system now permits the drums to stand on end and gives the "tail gater" (fuze pin puller) greater flexibility and safety in accomplishing his mission. Personnel need no longer move around on the tailgate of the aircraft. A greater flexibility in the rate of drop can be achieved, to permit higher concentrations on point targets and line concentrations over an area target. This system has reduced the amount of personnel required in the drop crew from 9 to 6, including the OIC, but exclusive of the air crew. The disadvantage of this system is the 45 minute aircraft loading time now required.

ITEM: Aircraft Mounted Manpack Personnel Detector, E63.

DISCUSSION: During the reporting period, the Chemical Section perfected the use of the Manpack Personnel Detector in an airborne mode.

OBSERVATION: See Inclosure 1.

ITEM: CS Persistency Test.

DISCUSSION: As a follow-up to the dry season CS persistency test performed in January 1967, a wet season test was begun during the reporting period. This test will be completed 15 August 1967.

OBSERVATION: Powdered CS persistency is reduced in the wet season. A complete report will be submitted during the next reporting period.

CONFIDENTIAL¹²

76

CONFIDENTIAL

AVDB-CM

31 July 1967

SUBJECT: Operational Report on Activities and Lessons Learned (U)

ITEM: CS Drum Burster.

DISCUSSION: The fuzing/burster system in use throughout most of this reporting period has proven to be 90% effective. The result has been an excessive number of duds during drops, particularly with the low altitude system.

OBSERVATION:

a. This fuzing/burster system consists of the following components.

(1) M4 incendiary burster, modified by replacing the pyro explosive with Composition C3.

(2) A Fuzing system consisting of a number 6 blasting cap, $1\frac{1}{2}$ " or $5\frac{1}{2}$ " of time fuze, and an M2 fuze igniter.

b. This system has the following disadvantages.

(1) The burster system will only destroy 1/3 - 1/2 of the CS drum.

(2) The fuzing is highly susceptible to humidity effects.

(3) Fuzing will occasionally fail from the fuze well in the burster.

(4) The low altitude ($1\frac{1}{2}$ " fuze) can at times fail to detonate the burster because the cap does not extend far enough into the C3 filler.

c. New fuzing and burster systems are being tested at the time this report is being prepared. The results of these tests will be reported in full in the next report of Lessons Learned.

1 Incl
as

John K. Stoner, Jr.
JOHN K. STONER, JR.
LTC, CmlC
Division Chemical Officer

TEL: Danger Main 123

CONFIDENTIAL

85-
CONFIDENTIAL

DEPARTMENT OF THE ARMY
HEADQUARTERS 1ST INFANTRY DIVISION
Office of the Chemical Officer
APO 96345

AVDB-CM

20 June 1967

SUBJECT: Manpack Personnel Detector (MPD) - E63

TO: Assistant Chief of Staff G3
1st Infantry Division
APO 96345

1. General: The Manpack Personnel Detector (MPD) - E63 was originally designed to be a man carried device with the capability of detecting concealed personnel. It was envisioned to be used by ground troops during counter insurgency operations in the Republic of Vietnam. Certain characteristics of the machine and the area of use made it impractical and ineffective as a ground oriented device. During the month of April, 1967, the 1st Infantry Division Chemical Section initiated a series of tests and tactical operations with the MPD modified for use on rotary wing aircraft. Results of these tests and operations indicated adaptability of the MPD to aerial reconnaissance operations.

2. Modification for Aerial Use: For aerial operations the following modifications were made on the standard MPD by the 79th Maintenance Battalion:

a. The read-out meter was removed from the probe to allow readings to be viewed by the operators while inside the aircraft.

b. The electrical output circuit was modified to allow the MPD to operate from the 28 volt DC power source of the helicopter. This modification consisted of rewiring the device for an electrical cord which could be plugged directly into the aircraft electrical system, eliminating the need for the original battery pack. This provided a constant and reliable source of operating power.

3. Aircraft Installation Procedures:

a. Excellent results have been obtained by attaching the probe of the MPD to the "belly" of the helicopter in the vicinity of the forward skid brace. Nylon cord is used to secure the probe to the brace.

b. The back pack group of the MPD was placed inside the helicopter in front of the operator, rested directly on the floor of the helicopter, and held upright for operation. Holding the instrument upright

End/

72
CONFIDENTIAL

CONFIDENTIAL

86

AVDB-CM

20 June 1967

SUBJECT: Manpack Personnel Detector (MPD) - E63

handicapped the MPD operator when he tried to calibrate the device for operation. Consequently, a holding rack was designed to secure the MPD and allow the operator freedom of both hands to calibrate the instrument. Reduced sensitivity and equipment malfunction indicated that the MPDs were receiving considerable shock from the vibrations of the helicopter. Shock absorbing springs were then attached to the base of the holding racks. This greatly reduced the vibration of the machine and increased the reliability of instrument readings.

4. Operational Procedures:

a. The Division Chemical Section organized MPD teams in the following manner:

- (1) One officer and two MPD operators.
- (2) One detector helicopter (UH-1D) with crew.
- (3) One light fire team (two UH-1B gun ships).

b. A high degree of success has been obtained by using the MPDs in pairs. In case of mechanical or electrical failure of one, the mission can still be accomplished. Also no two MPDs respond alike, therefore combined data from both has given the best results.

c. After "take off" the MPD should be calibrated at an altitude of at least 1500 feet to obtain a clean background reading. At this altitude there are relatively few effluents present from human habitation and presence except when flying over a large village or city. The normal operating level is from 10 to 15 microamps.

d. Wind direction should be determined by smoke before starting the operation. The detector helicopter should make its run perpendicular to the wind beginning at the downwind edge of the target area. This insures that the helicopter doesn't pick up its own exhaust trail and that the path of the helicopter crosses all wind blown effluents.

e. For safety and best machine performance, the detection helicopter should fly 10 to 20 feet above the trees. (Note: Pilots should be cautioned not to scrape trees, since this may cause severe damage to the probes.)

f. The best aircraft speed has been between 80 and 90 knots. Flying over 90 knots has caused the light fire team to lose contact with the detection ship. Flying slower than 80 knots makes the detector helicopter more vulnerable to hostile fire.

79

CONFIDENTIAL

87

CONFIDENTIAL

AVDB-CM
SUBJECT: Manpack Personnel Detector (MPD) - E63

20 June 1967

g. The best system to date used to plot the location of detected "hot spots" has been:

(1) Upon receiving a reading of approximately 50 on the read-out meter, the operator shouts "hot spot."

(2) The coordinator instantaneously relays "hot spot" by radio to the fire team.

(3) A plotter in one of the gun ships notes the coordinates of the hot spot (approximately 200 meters to the rear of the UH-1D). The mark 200 meters behind the helicopter is an adjustment for meter response and delay in notifying the plotter.

h. Originally a smoke grenade was thrown by the MPD operator when a high reading was obtained. However, this method of marking was abandoned in favor of the voice command because it was found that in many instances the smoke was trapped by the jungle canopy and could not be seen through the vegetation. Also it was felt that dropping the smoke into the hot spots might indicate to the VC that their positions had been spotted, enabling them to move or take other action.

i. When the detector aircraft is flying at tree top level, it is difficult for the pilot to determine his position in order to cover the target area. A satisfactory solution to the problem has been for the plotter in the gun ships to inform the UH-1D pilot when he has reached the boundary of the target area. The UH-1D pilot can then alter his course to remain on target.

5. General Observations on the Effects of Weather on Aerial MPD Operations:

a. It has been found that the optimum wind speed for the best meter readings is 5 knots. Stronger winds make it difficult to handle the helicopter at low altitude; slower wind speeds necessitate a tighter flight pattern over the target area to pick up the targets.

b. The best detection results have been obtained when missions were flown during the morning hours (0830 - 1100), especially with a low ceiling.

c. Poor results have been obtained when missions were flown during rain storms because aircraft have had difficulty in maintaining proper altitude and direction. Also the corona points in the MPD probe became wet and ceased to function properly.

80

³
CONFIDENTIAL

CONFIDENTIAL

88

AVDB-CM

20 June 1967

SUBJECT: Manpack Personnel Detector (MPD) - E63

d. Poor results have been obtained immediately following rain storms.

e. Satisfactory to poor readings have been obtained in the hot afternoon hours.

f. Very poor readings have been obtained during periods of surface wind turbulence. The "smells" have dissipated faster and the detector ship has not been able to fly as low as desired.

6. Conclusions: Results to date indicate that the Manpack Personnel Detector E63 is an excellent tool for detection of areas of current or recent enemy activity. However, it gives only a qualitative measurement and will not indicate the exact size of the force located at a point. High readings at several points in a relatively close area may indicate a large force. A sample of confirmed targets that were originally detected with the MPD follows:

a. High readings between two points - B52 strike following day exposed bunkers, tunnels, trenches, and foxholes.

b. High readings at one point - Afternoon of same day Sigma Team made contact with estimated 100 VC 300 meters from the point.

c. High readings between two points - Air strike in afternoon resulted in secondary explosions.

d. High readings between two points - Subsequent artillery and air strikes exposed bunkers.

e. High readings at one point - Subsequent artillery and air strikes resulted in 32 bunkers exposed and 1 VC KIA (BC).

f. Continuous high reading between two points - An agent report placed the 272d VC Regiment at this exact location on the same day.

1 Incl
SOP for Reporting
Bloodhound Mission Results

ALVIN R. HYLTON
LTC, CMIC
Division Chemical Officer

TEL: Danger Main 123

CONFIDENTIAL

81

69
HEADQUARTERS
1ST INFANTRY DIVISION ARTILLERY
APO US Forces 96345

AVDB-RAT

CONFIDENTIAL

16 August 1967

SUBJECT: Operational Report on Lessons Learned (U)

TO: Commanding General
1st Infantry Division
ATTN: AVDB-T
APO US Forces 96345

1. (U) Reference 1st Infantry Division Regulation 870-1, dated 16 February 1966, Subject: "Historical Activities", with change 1, dated 15 April 1966.

2. (C) In compliance with referenced regulation, the following report, for the period ending 31 July 1967, is submitted:

Item: AMMUNITION RESUPPLY

Discussion: Ammunition resupply presents a major problem during operations requiring a firing battery to be separated from the parent battalion.

Observation: The requirements for ammunition often exceeds the battery's capability because of large expenditures and long distances from the firing position to the MSP. Both battalion and battery ammunition sections are often committed to fulfill the needs of one battery.

Item: FIRE SUPPORT BASE

Discussion: When a fire support base is established with other combat arms, primary consideration must be given to the artillery firing positions. The artillery unit commander must be allowed to position his units commensurate with his mission and capabilities within the position area.

Observation: After the artillery firing position has been established, coordination with the other forces occupying the fire support base should be accomplished regarding security, positioning, and consolidation of the position.

Item: PREPARATION OF GUN PARAPETS AND AMMUNITION DUMPS

Discussion: In an artillery position, guns and ammunition

CONFIDENTIAL

82

CONFIDENTIAL

AVDB-RAT

16 Aug 67

SUBJECT: Operational Report on Lessons Learned (U)

90

dumps must have parapets built as soon as possible. In an extended operation the construction of well protected ammunition dumps should be a major primary consideration. Often with the concurrent heavy firing commitment the unit is unable to properly re-erect the guns or the ammunition if the work must be done by hand.

Observation: Engineer support can, in most instances, provide a bulldozer for the establishment of a fire support base. The bulldozer is invaluable to the artillery unit for the preparation of position parapets. Even if the dozer is not available to the artillery unit for an extended period, it can quickly provide a dozed-up sand or dirt pile from which sandbags can be filled in less than half the normally required time.

Item: OVERHEAD COVER IN FIELD POSITIONS

Discussion: When preparing field positions, overhead cover is constructed primarily with materials carried to the position or readily accessible from the natural surroundings.

Observation: Overhead cover is accomplished in a minimum amount of time using eight foot engineer stakes as supports for cover material. When engineer stakes are not available, power saws may be used when available, to fell trees for the same purpose. When available, engineer stakes should be issued to units displacing to field positions.

Item: AIRCRAFT FLYING THROUGH THE GUN-TARGET LINE

Discussion: Aircraft continue to fly through artillery gun-target lines. This is especially true during periods of intense artillery activity.

Observation: All aviation units should be briefed frequently on the radio frequency and proper use of the artillery air warning net for each particular area. Firing must be suspended when aircraft are approaching or crossing the line of fire. Additionally, airborne liaison officers, air observers, commanders, and all personnel familiar with the artillery situation must be alert regarding aircraft safety. All of these personnel should have clearly defined authority to issue a "Check Fire" order if they detect any unsafe condition in the air space over the immediate area of operations.

Item: REGISTRATIONS WITH RADAR SET AN/MPQ-4A

Discussion: During the last few weeks several registrations have been conducted using the AN/MPQ-4A radar. This was done when an air observer was not available.

CONFIDENTIAL

CONFIDENTIAL

AVDB-RAT

16 Aug 67

SUBJECT: Operational Report on Lessons Learned (U)

Observation: Favorable results have been obtained with radar registrations. Several successful night registrations have been conducted. Due to the radar siting requirements it is necessary to stop the registration when rain clouds cover the area. In some cases an excessive number of rounds have been required due to the erratic bursts of the fuze M520. The new fuze M543, when received, should eliminate this problem.

Item: FUZE DELAY DURING PERIOD OF RAIN

Discussion: Check fire must be given when firing during periods of heavy rain. This is because of the possibility of rain setting off a point detonating fuze when set on the "quick" setting.

Observation: During heavy rain, the fuze setting should be changed to "delay" to avoid a premature detonation of the round. One problem with fuze delay is the probability of a dud is increased. The condition of the ground is an important factor. Also, the supported unit commander must be informed that fuze delay is being fired and that the effect will not be the same as with fuze quick.

Item: CARRYING AIR-LIFT EQUIPMENT REGARDLESS OF HOW MOVEMENT IS MADE.

Discussion: A unit from this organization was moved to a field location by Air Force fixed wing aircraft. Several days after the move they were required to participate in an "Artillery Raid" move by CH-47.

Observation: Regardless of how a unit moves to a field location, units must be prepared for any eventuality and must carry all air-lift equipment with them at all times.

Item: "ARTILLERY RAIDS" WITH 105mm TOWED HOWITZER, M2A2 AND CH 47 HELICOPTERS.

Discussion: "Artillery Raids with 105mm Towed Howitzer M2A2 and CH 47 Helicopters require detailed planning and coordination between the battery commander and the pathfinders of the lifting unit. The pathfinders must be given a complete and comprehensive briefing on the location of the LZ and especially on the desired placement of the howitzers and ammunition. If possible, the battery commander and the pathfinders should conduct a joint aerial reconnaissance of the LZ. When the airborne loads arrive at the touch down points, the battery commander and the pathfinder must work together devoting their close attention to the exact placement of each howitzer. Ammunition loads must be placed in close proximity to the guns; however, the placement must be selective in order to facilitate the quick delivery of fire while also providing sufficient room for loading ammunition residue for backhaul.

84

3

CONFIDENTIAL

CONFIDENTIAL

AVDB-RAT

SUBJECT: Operational Report on Lessons Learned (U)

16 Aug 67

92

Observation: Close coordination between a firing battery commander and the pathfinder is imperative if the occupation of an "Artillery Raid" position is to be rapid and orderly.

Item: AIRLIFT OF ARTILLERY UNIT TO COMBAT ZONES BY FIXED AIRCRAFT

Discussion: The sequence of loading an artillery battery for movement by fixed wing aircraft is a major factor in air movement planning. The first load should be the battery command-FDC group with the majority of radio equipment. For subsequent lifts, consideration must be given to equipment availability in the forward area and to coordination which may be effected. Class V supply should be coordinated with units in the forward area if possible. If ammunition, loaded on trucks, is awaiting arrival of the artillery unit, the response to calls for fire will be faster and in greater volume.

Observation: The sequence of loading an artillery unit for movement by fixed wing aircraft is dependent on equipment available in the forward area and the coordination for the use of this equipment.

Item: METEOROLOGICAL DATA

Discussion: Weather changes during the monsoon season are frequent and unpredictable. Caution must be exercised in utilizing metro data that is obviously different from the current weather conditions at time of firing.

Observation: Certain weather patterns can be established by studying a record of metro messages over at least a three month period. This is particularly true with regard to wind direction. A better approximation of current weather data can be made and more accurate fires delivered if the knowledge gained by study of these patterns is applied when a metro is received which is obviously different from current conditions. By using this method, metro messages obtained during a flash storm can be discarded or corrected to reflect current weather data.

Item: AMMUNITION BAGGED FOR EMERGENCY AIRLIFT OPERATIONS

Discussion: Class V is very important in the conduct of operations. It is SOP that when units move they their basic load of Class V with them. Emergency operations often arises which require immediate action on the part of all concerned.

Observation: The Class V requirement for emergency airlift operations is met by each battalion maintaining bagged ammunition on hand. All bagged ammunition is available for use by any battalion that is participating in an operation that requires rapid Class V resupply.

FOR THE COMMANDER:

CONFIDENTIAL

Ronald A. Pistone
RONALD A. PISTONE
Major, Artillery
Adjutant

85 4

93

DEPARTMENT OF THE ARMY
HEADQUARTERS 1ST INFANTRY DIVISION
APO 96345

AVDB-T

5 August 1967

SUBJECT: Ambush

TO: SEE DISTRIBUTION

1. GENERAL: The ambush, by its very nature, offers the greatest potential for killing VC. Every day ambushes established by units of the Big Red One make contact with VC elements. Yet the resultant body count is unacceptably low. The obvious cause for these poor results is basically a failure to plan and conduct the ambushes properly. This letter provides guidance on certain aspects of the methods and techniques of the ambush which will be implemented by all units of the 1st Infantry Division.

2. DISCUSSION: a. An ambush is a surprise attack from a concealed position on an enemy force. The key word is SURPRISE. Without surprise, there is no ambush. Further, in considering the general nature of an ambush, it is necessary to think in terms of its application to Vietnam; ambushes are offensive in nature. It is important to have this understanding.

b. The primary considerations of the ambush are:

(1) Planning and organization

(a) Don't delay in alerting those that will conduct the ambush. Give them time to prepare.

(b) Give maximum time to selecting the ambush site - coordinate with all personnel, particularly ARVN, who may have detailed intelligence and knowledge of VC routes and activities.

(c) Conduct a ground or air reconnaissance whenever possible. As a minimum, a good map reconnaissance is essential.

(d) Keep the plan SIMPLE. An elaborately conceived plan merely introduces unnecessary aspects that increase the chances for mistakes.

(e) Coordinate thoroughly with all individuals that can increase the prospects for success. Pin down the specifics of the intelligence situation, fire support, and the unit ready reaction force.

86

AVDB-T
SUBJECT: Ambush

5 August 1967

94

(f) Tailor the ambush force to its mission. Don't permit the arbitrary employment of a squad, platoon, or company as it exists. If additional men, equipment, or weapons are required, get them. Proper equipment to accomplish the mission and meet emergencies must be carried. Each man should carry a basic load of ammunition, and maximum use should be made of grenades and claymores.

(g) Coordinate with the element through whose lines the ambush force will pass. Establish the location of mines, early warning devices, lanes through protective wire, CPs and LPs, and defensive concentrations.

(h) Plan for every eventuality that may be encountered during the movement to, conduct, and return from the ambush. Issue a detailed order based upon the plan.

(i) Rehearse. Insure each man knows his job.

(j) Inspect each patrol member to insure that he has the proper equipment; that his equipment has been muffled or taped to prevent noise; and that he carries no cigarettes and lighter or other objects whose use could jeopardize the accomplishment of the mission and the lives of the members of the patrol.

(k) Plan H&I and other supporting fires so that the volume of friendly fire is not such that it precludes or discourages VC from approaching the ambush site

(l) A reaction force must be planned for and prepared for each patrol. Normally a reaction force will only be employed when the patrol encounters serious difficulty. The best security for a patrol is stealth on movement into position, maintenance of surprise, planned heavy volume of fires to include artillery and mortar after the ambush is sprung.

(m) Time distance of patrols from reinforcing forces will vary due to status of proficiency, size of the ambush patrol, enemy situation, and terrain. Normally reinforcements should be capable of reaching the patrol within approximately 30-minutes.

(2) Conduct:

(a) Movement to the ambush site must be accomplished by stealth. Should the ambush force be detected during its movement, then it has failed before starting.

(b) Upon reaching the ambush site, proceed through it at least 100 meters before halting, reconnoitering on the way. (See Inclosure 1). Then stop and establish a defensive perimeter, placing particular

AVDB-T
SUBJECT: Ambush

5 August 1967

emphasis on security; fire in defensive concentrations for the ambush. This latter action will insure that when needed, effective fire support can be employed immediately, since the concentration will already be cleared for firing and the initial fire request can include adjustments from the known concentrations, as the situation requires.

(c) Observance of noise and light discipline must be stressed: no talking or unnecessary movement. Then, at the proper time (depending upon whether the ambush is during daylight or the hours of darkness), deliberately and quietly the personnel and weapons are positioned. Thereafter, no sound or movement must be made. The pace of extended operations normally dictates less than 100% alert on ambush patrols. However, at all times the leader or his second in command must be alert and able to alert the patrol. The alert system must be such that the patrol can be immediately alerted, and the ambush triggered without noise or movement. Eating or smoking will not be allowed in an ambush position.

(d) Careful planning, patience, and aggressiveness are the keys to success. The patrol must wait until the target is well within the killing zone. Triggering an ambush too soon is one of the most common reasons for failure. When the ambush is triggered the patrol must lay down an immediate heavy volume of fire and aggressively follow up to search the killing zone, and finish off the target force.

(e) The ambush leader is responsible for triggering the ambush. No one else, unless so specifically designated, will trigger the ambush. Judgment must be exercised in deciding the exact moment to trigger the ambush. Again, experience has shown that many ambushes fail as a result of premature triggering. Wait until the enemy is well within the killing zone and as close to the ambushers as his route will take him.

(f) Upon the initiation of a definite and definable signal, the ambush will be sprung. A specific amount of ammunition and ordnance, pre-established, will be expended and then all firing will cease. Initially, fire must be low and then can be adjusted on target. A ricochet from a round fired low will still kill; a round fired high is lost.

(g) If all the enemy are not killed in the initial fires, finish them off or if possible, take them prisoner.

(h) Employ supporting fires quickly, as appropriate. The primary mission of the ambush patrol is to kill VC with its own weapons. However, many situations will come up where the patrol detects a VC force which does not move into the patrol's killing zone. The patrol leader must be proficient in using indirect fire to engage such forces, or to protect

AVDB-T
SUBJECT: Ambush

5 August 1967

his patrol if necessary.

(1) Upon completion of the ambush, conduct a quick search in the ambush site. Then either move to a preselected support site or return to the secure base, as appropriate. In any case, move immediately; do not linger at the ambush site.

c. Ambush configurations:

- (1) Linear (See inclosure 2) (Preferable for most situations).
- (2) "L" shape (See inclosure 3)
- (3) Triangle (See inclosure 4)

FOR THE COMMANDER:

J. C. Pennington
 J. C. PENNINGTON
 LTC, AGC
 Adjutant General

4 Incls
as

DISTRIBUTION:

A(mod-1)

97

Movement into an Ambush Site

Move through the site

Fire in defensive concentrations

Occupy ambush site

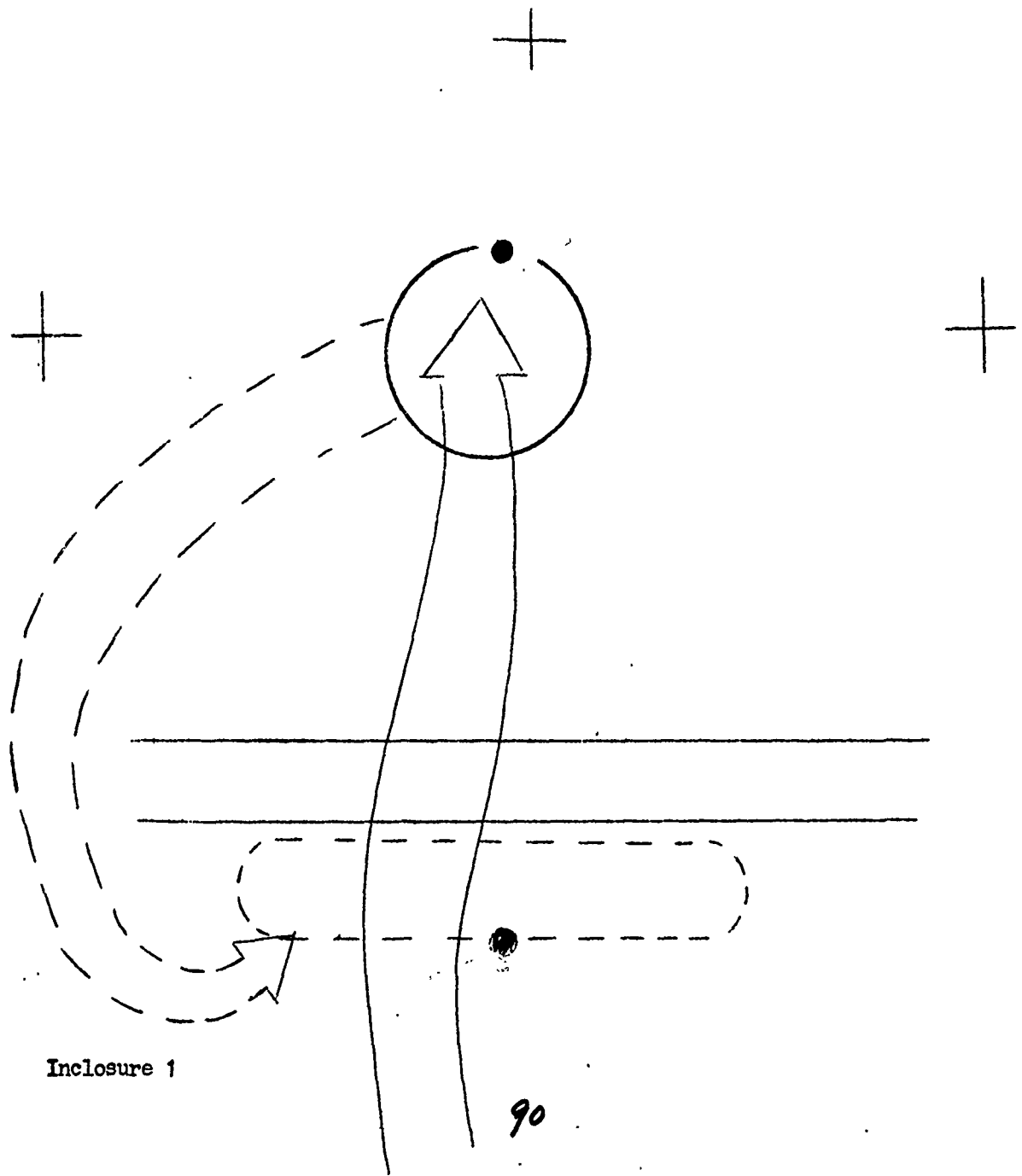

Inclosure 1

90

Linear Ambush

Employed by all sized forces (Depicted below for a squad)

#S 1 2 and 3 represent an attached machinegun

#12 is the squad leader

#S 4 5 and 3 provide flank security

#13 provides rear security

Minimum 10 meters between positions

Two men per position

Legend

- Friendly Forces ○
- Enemy Forces ⊙
- Killing Zone (hatched oval)
- Concentrations +
- Machinegun →
- Claymore () +

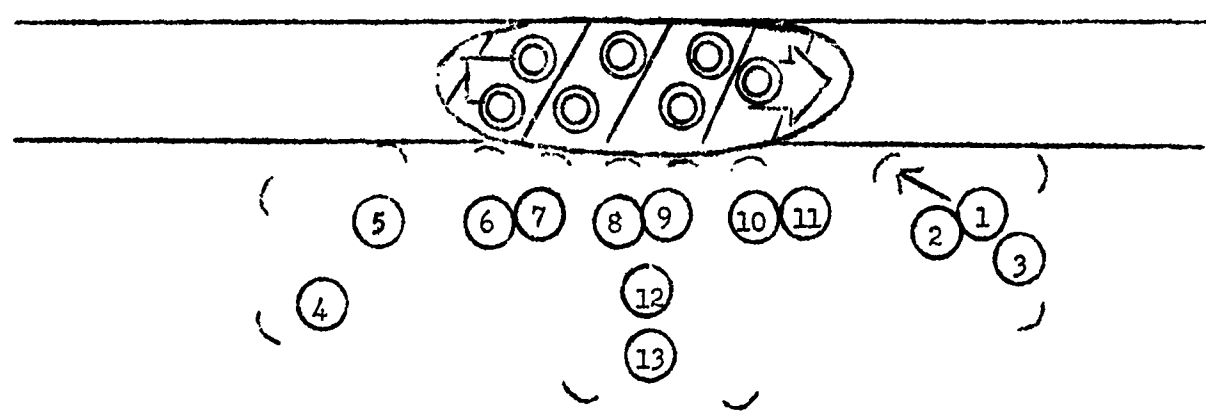

Inclosure 2

99

"L" Shaped Ambush

Most frequently employed by squads

#S 1 2 and 3 represent an attached machine gun

#12 is the squad leader

#S 3 4 5 10 and 11 also provide flank security

#13 provides rear security

Minimum 10 meters between positions

Two men per position

LEGEND

- Friendly Forces ○
- Enemy Forces ⊙
- Killing Zone ▨
- Concentrations +
- Machine gun →
- Claymore ()

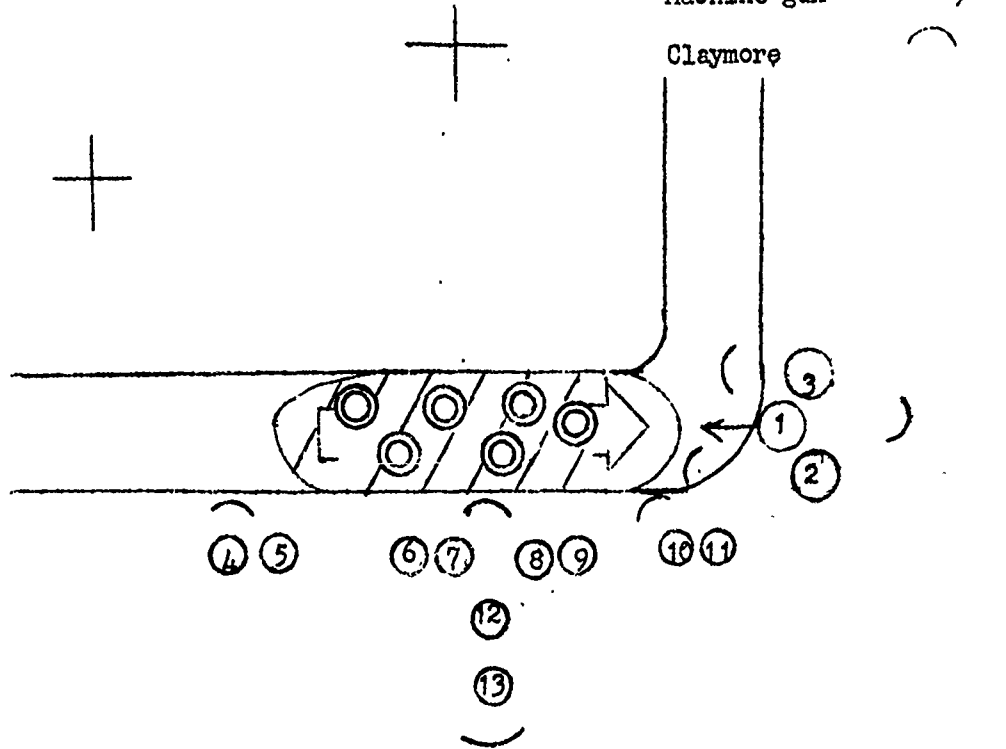

Inclosure 3

92

Triangle Ambush



150

Employed by a platoon or larger force

- Methods and techniques employed are the same as for other type of ambushes

Characterized by affording two killing zones

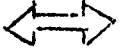
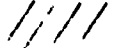
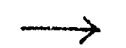
Legend

- Friendly Forces 
- Enemy Forces 
- Killing Zones 
- Machineguns 
- Machinegun psns 
- Concentrations 

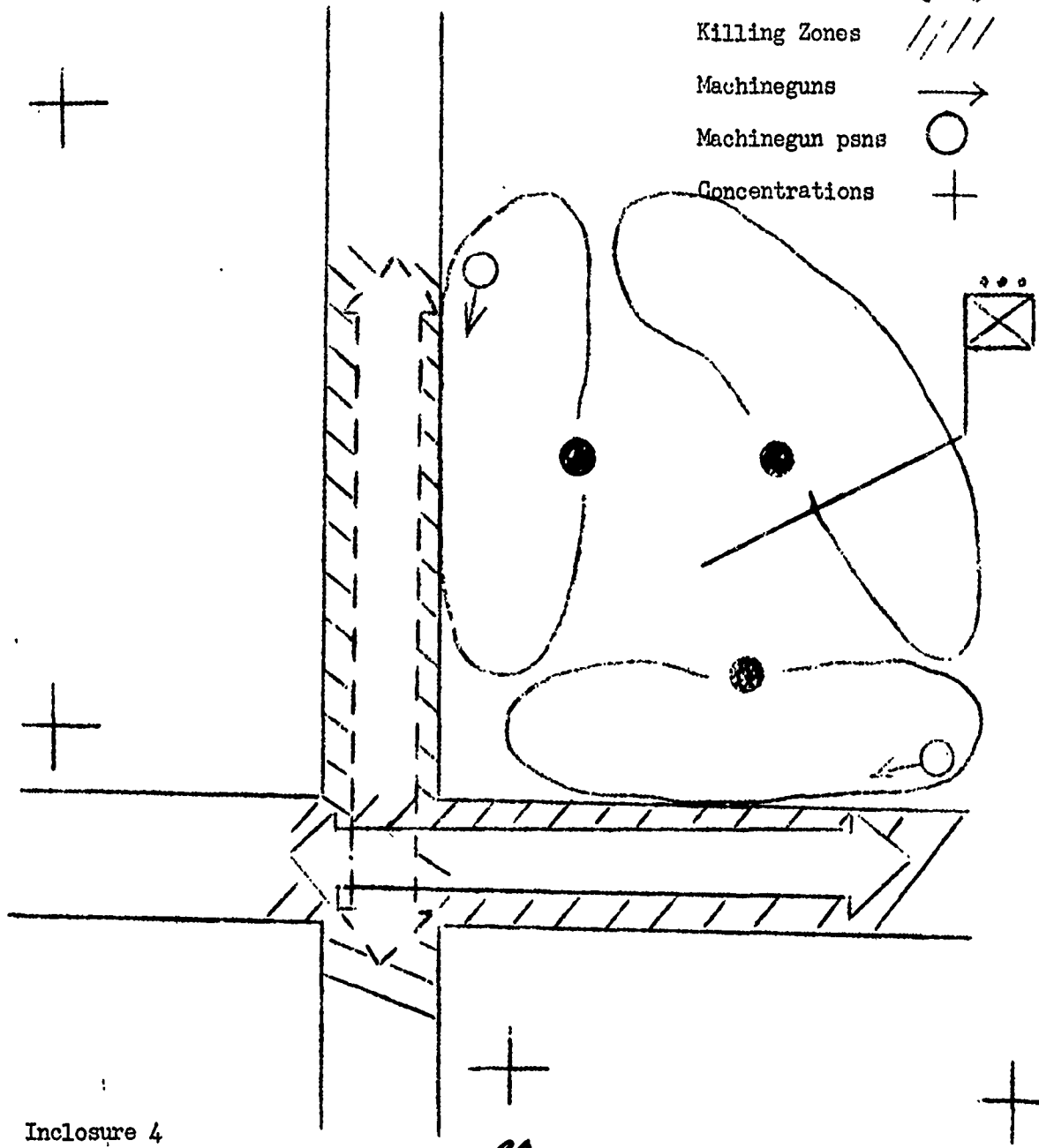

Inclosure 4

93

101

CONFIDENTIAL

DEPARTMENT OF THE ARMY
HEADQUARTERS 1ST INFANTRY DIVISION
17th Military History Detachment
APO San Francisco 96345

AVDB-T

5 July 1967

The Battle of AP TAU O

On 7 June 1966, A Troop 1-4 Cavalry received the mission to go to AN LOC as intelligence reports from that area indicated a VC attack on AN LOC as part of the "Monsoon Offensive". The next town north on Highway 13, LOC NINH, had been attacked just prior to this action.

A Troop departed from its base at PHOU LOI at 0830 hours on the morning of 8 June 1966. They stopped to refuel their vehicles at LAI KHE which is 25 kilometers from PHU LOI. The convoy consisted of seven M 48 A3 tanks, twenty-five M 113 armored personnel carriers, two M 132 flame thrower tracks, and one VTR. One of the tanks was an engineer dozer. At LAI KHE they picked up a platoon of engineers who mounted their tracks.

On the way to LAI KHE there were two breakdowns, but the column continued to move on to LAI KHE. Captain Ronald Copes, Executive Officer of A Troop, was in command of the trail party. His job was to "police up" the stuck and broken down vehicles. One of the breakdowns was of a permanent type and had to be left at LAI KHE for repairs. In the trail party there were two M 113s, one VTR, and one M 48 A3 tank, that had dropped out of the main body and remained with Captain Copes.

From LAI KHE they started to push on to CHON THANH in order to get into AN LOC by sundown. At LAI KHE's northern checkpoint, an old French built guard tower covering Highway 13's approach into LAI KHE, the trail party picked up an Armored Vehicle Launcher Bridge (AVLB), as it was stuck in the stream crossing, it was pulled out and it joined the column. Then they continued up Highway 13 moving off the road and traveling parallel to the highway at points. The country north of LAI KHE was more heavily infested with VC Main Force units than the area to the south where one finds mostly local guerrilla bands. There were some roadblocks of brush and trees across Highway 13 which they moved around to save time and pushed on. The road blocks were mainly designed for the purpose of VC tax collection.

The trail party arrived at MINH THANH and kept moving to within 8 kilometers of the main body when the trail party heard on radios that the lead tank of the main column had been hit by a command detonated shaped charge mine at 1415 hours. At that time the whole main column had come under fire from automatic weapons, small arms, recoilless rifles, and mortars from prepared ambush positions. This was the first known time the VC had tried to register mortar fire on track vehicles. The three platoon column took up three kilometers of the road and the VC had it all covered by fire. Intelligence later learned through captured documents that it was the 272d Viet Cong "hardcore" regiment that was dug in along the road parallel to the column.

The trail party was now 8 kilometers south of the main column moving at about 35 miles per hour. Immediately when the attack began on the main column the trail party commander informed his elements of the attack. Captain Ralph Sturgis, the main column commander told Captain Copes not to come up, but to go back to CHON THANH, and form a perimeter in an open field to the south of the town and wait, while monitoring the action on the radio.

DOWNGRADED AT 3 YEAR INTERVALS
DECLASSIFIED AFTER 12 YEARS
DOD DIR 5200.10

CONFIDENTIAL

94

CONFIDENTIAL

102

There was ARVN artillery at AN LOC and CHON THANH, however the ambush site was out of range of their 105mm firing fan. The VC had selected and planned a good ambush site. It was learned from this operation to always move with artillery support. They did, however, have a Forward Air Controller (FAC) overhead, but the "air cap" immediately available with the FAC also became SOP as a result of this battle.

The trail party sat back at CHON THANH and listened to the battle for about six hours. At about 1600 hours the 1-4 Cavalry Squadron's S-3 Major Edwin Taylor, flew over in a helicopter and told the trail party commander that the trail column was to move forward as things were dying down. He told Captain Copes the battle situation, most of which Captain Copes already knew from reports over the radio. A tank and an M 113 had gotten stuck and separated from the main body at a bridge crossing. Also an M 113 was on fire, and 1 M 113 was missing. While it was still daylight, the FAC saw the M 113 driven into the woods by the roadside with its lights on. This M 113 was later recovered. The S-3 also told Captain Copes to leave the AULB in the CHON THANH ARVN compound. The trail party knew the VC were firing 57mm recoilless rifles and mortars. Also Captain Copes knew that several tracks were badly damaged but only one was burning.

The column started moving north out of CHON THANH on Highway 13 at 1620 hours. The trail party moved at a speed of about 20 miles per hour. As they continued to monitor the radio they learned that a tank and M 113 had been separated from the main column and had lost radio contact with the troop Commander Captain Sturgis. Captain Copes, however, had contact with them both. Captain Sturgis told Captain Copes that the VC were trying to overrun him. Captain Copes told him that the trail party was coming up to give him support. The tank commander told Captain Copes by radio that he had moved to the end of the main body to assist the M 113's. The trail party was just leaving CHON THANH when he informed them that the VC were trying to swarm over him, but Tactical Airpower was driving them off. He went on to say that the VC had tried to set up a 57mm recoilless rifle in the road, but he had stopped them with his weapons.

As the trail party moved up the road they reached a tank dozer that had gotten stuck trying to get off the road. The crew inside were buttoned up as they were receiving small arms fire from VC that were all around the tank. After a few bursts the VC were driven off and the tank dozer was retrieved. At that time the Squadron Commander, LTC Leonard Lewanc landed his helicopter and informed Captain Copes what was going on. He told him the VC were moving south towards the trail party and that the troop was now regrouping. He went on to say that an Infantry Battalion, the 2-28 Infantry, was being inserted into an LZ about three kilometers to the north of the main column's body. By the time the Infantry reached the column it was night and the battle was over.

After the colonel left Captain Copes started up his column of two tanks, two M 113's and one VTR. They moved up the road four kilometers south of the "lost" tank and M 113, when they were told by the "lost" tank commander that the VC were dropping "pancake mines" on the road,

When the trail party was one kilometer from them, the lead tank hit a mine on the road. The tank commander of the lead tank was Sgt. Charles Norris. His driver Sp 5 Hugh Oliver, was badly hurt, and the vehicle had some minor damage. Captain Copes stopped his column and radioed ahead his situation. His next action was to check out the casualty situation. He asked the tank if it could move under its own power? The answer was "yes", and the gunner of the tank became its driver; he was Sp 5 Smith. The trail party continued about 500 meters when the same tank hit another mine. This time mortars, recoilless rifles, and small arms cut loose on the column from the tree line.

95

2

CONFIDENTIAL

CONFIDENTIAL

163
Captain Copes ordered his vehicles to keep moving around and to try not to present themselves as a vulnerable target. Then he checked out the damaged tank. Captain Copes was riding in an M 113. At this moment the TAC air was forward of his position and in a couple of minutes they came in hitting the enemy positions. The trail party returned the VC fire by spraying the bushes and trees with high explosives, cannister and machine gun fire. Captain Copes told the tanks that he wanted "cannister fired into the woodline". The recoilless rifle fire slackened, but the VC mortars continued to fire at them. All of the tracks took hits from the small arms fire, but the rounds didn't go through the armor plate.

The lead tank then took 2 direct hits from a 75mm recoilless rifle in the turret and blasted Staff Sergeant Charles Norris straight up into the air for about 5-8 feet and set the tank ablaze. Captain Copes saw him go out of the turret but didn't see him land in the bushes. He lived through the battle although he was wounded. Mortar fire continued to come in. Cliver was thrown into the bushes and he lived. Smith and a 4th man were killed inside of the tank.

While they were firing into the woodline and the tank was burning Captain Copes asked the FAC for airstrikes. The jet fighters streaked on the target area and adjustments were made where Captain Copes wanted the maximum force placed.

Captain Copes saw Sgt Norris in need of help so he tried to help him get into his M 113. While doing this a VC threw a 75mm shell packed with explosives into the M 113. The bomb landed in Captain Copes lap. He quickly grabbed the bomb with his left hand and at the same time grasped his M-16 rifle with his right hand. He heaved the bomb package up and out of the track, and upon quickly turning his head, he saw the VC that threw it. He instantly aimed the M-16 and killed the VC and ducked back inside the M 113 just before the bomb exploded outside of the tracks rear.

All of the enemy fire was coming from the west side of Highway 13. The VC had made fortified revetments using 55 gallon diesel drums and sandbags for walls. The drums were filled with dirt for greater strength. The enemy camouflage had been excellent as the positions could not be seen from the road. The drums were stacked two high and indicated that the VC had pre-planned the ambush site for a long time. Captured VC later said they were waiting for 2 or 3 days in ambush for something to come along. Another POW said that they were expecting an ARVN resupply convoy not a "hard skinned" armored column. Up to this date no United States Military Vehicles had gone north of CHON THANH. The enemy ambush had "swallowed some bad bait" which Maj General W. E. DePuy, 1st Infantry Division Commander, had given to the VC by use of cover and deception.

After shooting the VC, Captain Copes went down inside the track to the radio and told the other tracks, who were stopped at this time, to keep spraying the woodline. It was later learned that when Sgt Norris hit the ground, after being thrown from the turret, he landed beside a VC. They both looked at each other, scaring each other, and both grabbed at the VC's weapon. Then both of them realizing their situation released the weapon simultaneously and ran in opposite directions. Sgt Norris ran towards the command M 113 and was taken aboard.

The fight started at 1700 and now it was 1740. Small arms fire was still coming in and the trail party had one tank burning. Captain Copes tried to decide whether anyone was still inside the burning tank as he didn't want to leave anyone behind. The tank was burning and exploding so much that he didn't think anyone was still inside the burning tank. He didn't know at the time that it was only flares and smoke exploding inside the tank. Captain Copes decided to leave the tank and move on to the main column.

96

3

CONFIDENTIAL

CONFIDENTIAL

104

With Sgt Norris on his track Captain Copes called Captain Sturgis on the radio and told him that the trail party was on their way to him again. They drove around the burning tank and came to a ditch. As the bridge across the ditch had been blown up they went into a dry streambed and made it across. The enemy fire was sporadic as the airstrikes were strafing the woodline. Captain Copes told Sgt Blair to take his "lost" tank and M 113 and fall into the rear of the column as the column passed them. The M 113 that Sgt Blair's tank was guarding had broken down earlier and the crew had made repairs under fire. The mechanic who made the repairs was Sp 5 Robert Bolling.

The trail party continued to push ahead for two kilometers and when Oliver joined the trail party, with his tank, they closed to the main party perimeter at 1815 without incident. The troop perimeter was quiet at this time as helicopters were bringing supplies of fuel, food, ammunition, and water. The main body had three tanks badly damaged. All of the vehicles had been hit by enemy fire but not all were serious. Four M 113s were badly damaged. During the battle there were 15 US KIA and 34 WHA. The enemy losses were 170 VC KIA by body count, 250 VC KIA by estimates made by the FAC, 4 VC captured, 42 weapons captured of which 12 weapons were crew served. Most VC wore green fatigue uniforms, some wore the familiar black pajamas, and some wore light brown uniforms. The documents found on one of the dead VC identified him as a Chinese Communist Adviser.

The mysterious M 113 vehicle which a FAC reported having its lights on was recovered the next day. The casualties from the vehicle had been evacuated earlier. Two Starlight Scopes in the vehicle had been disregarded by the VC. The VC at the time of this battle probably didn't know about Starlight Scopes and their use. The crew of the vehicle had driven the damaged track into the woodline and left it there with the headlights on so it could be evacuated later.

The flamethrower tank was successfully used during this action. With its coax 7.62mm machine gun and the flame thrower with a 250 gallon tank was right behind the Troop Commander, Captain Sturgis. He had just witnessed a track getting mortared and his track was maneuvering around when a recoilless rifle round went through his M 113 wounding his driver, Sp 4 James Dempsey, in the heel of the foot. Captain Sturgis had his observer, Sgt Nick Sapparito, take over driving the track. The Flamethrower track came up beside them and spotted the recoilless rifle trained and ready to fire again on the command track. The flame-thrower track commander, SFC Pearson Cole, took immediate action and opened up on the enemy recoilless rifle with the flame-thrower and burned it up at 40 to 50 meters distance.

Another interesting story of the action pertains to a Sgt Blair and his tank guarding the stuck M 113 near the blown out bridge south of the main convoy. Sgt Blair was an old infantryman and did not know too much about tanks. His military experience was that of a platoon sergeant and had just recently joined the Cavalry. It was his vehicle that had informed Captain Copes on the radio early in the afternoon about the mines, the M 113 that had gotten stuck, and about the VC trying to swarm over his tracks. This action was his first time in a tank. Knowing the urgency of the situation he reverted to being a loader. While throwing out the expended brass shell casings on the tank one of them got caught in the turret. This prevented the turret from turning. Realizing what had happened Sgt Blair jumped out of the turret and, while under fire, freed the shell case from the turret.

Another incident involves Oliver and the burning tank. When Sgt Norris was blown out of the turret, Oliver was also thrown into the bushes and knocked unconscious. He had been left behind for dead. When he came to, he looked around, saw the tank, started the engine, and drove it to the tail of the column at full speed. In doing this he saved the tank and received 2d degree burns from its hot insides. He was evacuated to Japan and decorated with the Silver Star.

97

4

CONFIDENTIAL

105-

CONFIDENTIAL

During the action the US Air Force brought in 43 sorties in strikes against the enemy. US equipment losses from this battle were one M 113 totally destroyed, all of the other damaged vehicles were repaired and returned to combat duty. The weather on 8 July 1966 was dry, hot, and clear. The morale of the troops was excellent.

1 Incl

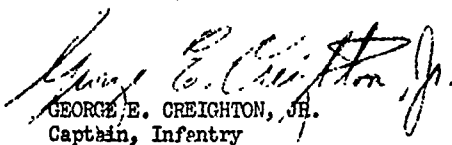
GEORGE E. CREIGHTON, JR.
Captain, Infantry
Commanding Officer

98

5

CONFIDENTIAL

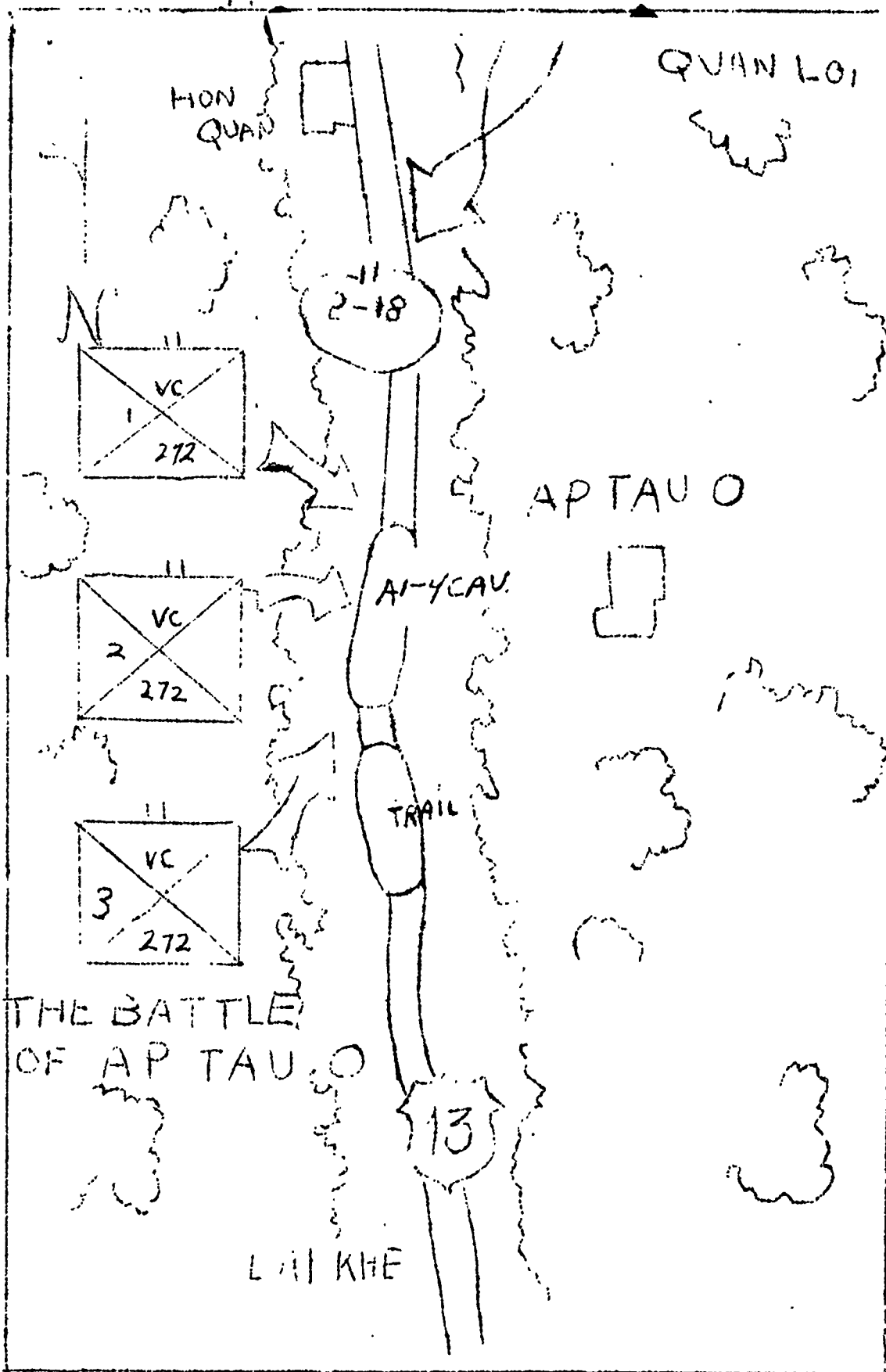

106

CONFIDENTIAL

107

DEPARTMENT OF THE ARMY
HEADQUARTERS 1ST INFANTRY DIVISION
17th Military History Detachment
APO San Francisco 96345

AVDB-T

1 May 1967

BATTLE OF AP BAU BANG
20 March 1967

At 1150 hours 19 March 1967 A Troop 3d Squadron, 5th Cavalry, under the command of Captain Raoul H. Alcalá, 095764, San Antonio, Texas, was deployed into the perimeter of Fire Support Base 14 with five officers, 124 enlisted men, 20 M-113 armored personnel carriers, six M-48A3 tanks and three M-106 4.2 inch mortar carriers. Their mission was to occupy and secure Fire Support Base 14. They moved into position at 1150 hours 19 March 1967 and organized a "wagon train" style perimeter defense and constructed "DeFuy foxholes". This type of foxhole had overhead covering and two firing ports placed at 45 degree angles from each side and is named after its originator, Major General William E. DeFuy.

The intelligence information supplied Captain Alcalá indicated the BAU BANG area was infested with local force guerrillas. These local guerrillas had been conducting tax collecting activities and probes against friendly forces in the area. Also, a well-trodden VC trail had been pinpointed by intelligence one mile north of BAU BANG. The captain decided to use the 2d platoon, under the command of 1Lt Harlan E. Short, 05536968, to establish an ambush along the trail at coordinates XT780487, at 1800 hours. While the 2d platoon was preparing the ambush site, the perimeter was realigned with the 1st platoon, under the command of 1Lt Roger A. Festa, 05053163, Orange, Connecticut, occupying the western half from 6 to 12 o'clock and the 3d platoon occupying the eastern half from 12 to 6 o'clock. B Battery, 7th Battalion, 9th Artillery, under the command of Captain Duane W. Marion, 05508032, occupied the center of the perimeter. A 25 per cent alert status was initiated and maintained until enemy activity commenced.

The VC Probe:

The Battle of BAU BANG was initiated by a VC probe at 2250 hours 19 March 1967. The VC probe commenced with a herd of 15 cows wearing bells crossing Highway 13 at a point 150 meters northeast of the perimeter. At 2300 hours, 19 March 1967, a wheel mounted .50 calibre heavy machine gun opened fire on the northeast sector of the perimeter. The machine gun was located on a berm of the railroad track which parallels Highway 13 thirty meters east of the highway. The initial burst of fire wounded PFC Eugene D. Rigsby, US56432117, San Francisco, California, in the leg. Tank number 39, commanded by Sp4 Eugene W. Stevens, US56423162, Santa Cruz, California, opened fire on the VC position with 90mm high explosive rounds and .50 calibre and 7.62mm machine guns. The tank trained its search light on the VC position, and tracks number 30, 32, and 34 blasted away. Captain Alcalá requested artillery fire from Fire Support Base 14 and LAI KHE to fire 500 meters to the east of the enemy position in order to block the Viet Cong's escape route. Captain Alcalá with the guidance received from his squadron commander, LTC Sidney S. Haszard, 060457, Needham, Massachusetts, chose not to concentrate the mass of his firepower on the enemy position. The VC heavy machine gun sprayed the perimeter with five blasts while receiving return fire. After this three minute fire fight the VC machine gun was silent, and no further action resulted. During the fire fight an enemy .50 calibre tracer round struck a box of C-4 on track No. 34, an APC, causing it to burst into flames. Sgt. James R. Musick

DOWNGRADED AT 3 YEAR INTERVALS
DECLASSIFIED AFTER 12 YEARS
DOD DIR 5200.10

100

CONFIDENTIAL

CONFIDENTIAL

108

RA52567890, St. Charles, Virginia, jumped onto the armored personnel carrier and threw the burning box of C-4 off, burning his hands badly. He was under steady enemy fire, and one .50 calibre round destroyed the M-60 machine gun mounted on top of the track. He jumped to the ground and attempted to extinguish the fire with sand.

A reconnaissance by fire along the woodline was conducted by 2Lt Hiram M. Wolfe II, OF109496, Louisburg, Pennsylvania, in track No. 36. He spaced the intervals of fire at 15-20 meters and fired periodically for about an hour. At 2310 hours Captain .icala reported to the 3-5 Cavalry net control station, "Firing has ceased now. We are using infra-red to scan the area of movement. The rate of fire received was too rapid for an M-60 and the bursts too long for an M-16."

During this lull the 2d platoon remained on the ambush site and went to a 50 per cent alert; the 1st platoon stayed at a 100 per cent alert, because it had fewer vehicles; the 3d platoon went back to a 50 per cent alert; and the headquarters platoon, reinforcing the 1st platoon, went to a 50 per cent alert. Everything appeared to return to normal.

The Battle:

The main Viet Cong assault began at 0030 hours at Fire Support Base 14 with an unknown number of 60mm mortar rounds, rifle grenades, RPG's and recoilless rifle fire. The initial mortar rounds hit Lt Festa's track No. 16 wounding Sgt Edward Brevell, US54380765, Port Arthur, Texas. According to SSgt Ronald R. Dokken, RA16499280, Madison, Wisconsin, the VC heavily peppered the perimeter for several minutes with about 100 rounds of mortar fire. He believed the VC were zeroed in well, because the rounds were accurately placed in and around the perimeter. Lt Festa said, "The VC mortar rounds were coming from the west." Brigadier General James F. Hollingsworth, O34155, Sanger, Texas, Assistant Division Commander - A, 1st Infantry Division, said, "Their mortar positions were located from 1,500 to 2,000 meters west of BAU BANG in and around an old village that had been destroyed some time in the past. The mortar positions were located by radar from the LAI KHE artillery base. As I recall, during the battle they (the counter mortar fire radar) reported to me that the mortars were firing from the west. I understood the counter mortar radar played an important role in picking them up. However, the most accurate way of picking up the mortars during this battle was by the two artillery observers that I had airborne at the time, who could see the flashes from the mortars. I think that a combination of both brought about the location of the mortars."

About the same time that track No. 16 was hit, track No. 12 took direct hits in the front and left side by a recoilless rifle round. A small fire erupted inside, and soon the entire M-113 was engulfed in flames. The track commander, SSgt Glasper Minor, RA53092987, Junction City, Kansas, evacuated his three wounded crew members to a nearby foxhole. SSgt Minor received shrapnel in both legs. Lt Festa evacuated these wounded men from their foxhole refuge later in the battle.

During the initial attack, tanks No. 38 and 39 of the 3d platoon were hit. Tank No. 38 was hit in the searchlight and then in the turret, wounding the tank gunner, Sp4 Ronald Davis, US54383541, Barnsdale, Oklahoma. Tank No. 39 took hits in the sponson box, the blower motors, and the air cleaner. No one was injured on tank No 39, and both tanks remained in the battle.

101

2

CONFIDENTIAL

CONFIDENTIAL

169

During the mortar and anti-tank bombardment, Captain Alcalá maintained contact with his squadron commander. Small arms and automatic weapons fire hailed into the perimeter, and the forward movement of enemy troops was detected.

At approximately 0048 hours Viet Cong infantry began a ground assault on the perimeter from the southwest, west, southeast and northeast. The assault from the northeast appeared to be only a diversion. The advancing Viet Cong laid down a base of fire and moved steadily forward, keeping close to the ground. Captain Alcalá said, "Their attack was well coordinated with their mortar fire. Not until they came out into the open from the trees did we realize how big an attack it was." The men on the battlefield observed most of the VC wearing black pajamas or fatigues of dark cloth. Some VC had olive drab fatigues and khakis. All of the observable VC wore Ho Chi Minh sandals. Lt Festa said, "Their weapons were clean, oiled and well cared for. Their ammunition was in plastic bags or bandoleer ammo pouches. The ammo in the bandoleers was wrapped in olive drab plastic bags. They all had entrenching tools, about one pound of unpolished rice, and most had M-1 bayonets. Those who had Mauser rifles had their bayonets fixed for a charge. Their medics had a regular well equipped kit."

At 0050 hours Captain Alcalá reported to his headquarters that he could handle the attack; however, he asked that a ready reaction force be readied in case it was needed. LTC Haszard acknowledged this request and alerted the 1st platoon of B Troop and the 3d platoon of C Troop. These platoons were instructed to move to the area and hook up with A Troop. It became evident to the squadron commander, after noticing the growing size of the enemy offensive, that he should move his command element to the scene of the battle. Captain Alcalá was given permission to alert his 2d platoon, on the ambush site, to prepare for movement into the perimeter.

Second lieutenant Wolfe detected VC movement in his 3d platoon sector. Track No. 30, a 4.2 inch mortar carrier, fired night illumination into the 3d platoon area. The illumination lit the area effectively and made it possible to see VC troops crossing the road in an east to west direction. Lt Wolfe ordered his platoon to commence firing; the VC were stopped suddenly by the steady volume of fire. The Americans noted that the VC had failed to make their customary sounds of charge, bugles, and rebel yells during their advance. Lt Wolfe said, "I think they were moving in quietly under the cover of darkness to mass for an all out attack on the perimeter."

The commander of track No. 38, SSgt George Hua, RA29034003, Kona, Hawaii, said, "I got two hits on top of my turret from a 60mm mortar, and two hits struck the gun shield below the gun tube from a recoilless rifle. The enemy rounds glanced off and did not penetrate the armor. The shock from the explosives popped open the hatch, wounding the driver, Sp4 James Carter, US54372312, Cleveland, Texas, in the neck, chest and legs. I tried to evacuate him, but he refused to leave the vehicle until I left. Another enemy round hit the blast deflector of the main gun, so we ended fire with everything we could get our hands on."

At 0100 hours Captain Alcalá was informed that a flareship with mini-guns, called "Spooky 742", and a light fire team of helicopter gunships were available and would be in position shortly.

The communist troops from the southwest were now hitting the perimeter hard. Track No. 10, a M-106, radioed SSgt Dokken in track No. 17, and said, "They are swarming all over my track; dust me with cannister." SSgt Dokken hesitated; he was afraid of the effects of the cannister on the crew of track No. 10. Track No. 10 answered, "My people are down, shoot!"

102
3

CONFIDENTIAL

CONFIDENTIAL

110

SSgt Florentino Catudan, RA50008329, Batac, Phillipines, commander of track No. 10, had a wounded man, Sp4 Richard B. Abke, US55894203, St. Claris Shores, Michigan, Realizing the seriousness of the situation, SSgt Dokken fired four or five cannisters in the direction of track No. 10. The commander of track No. 11, SSgt Rafael Ramos-Rosario, RA50109463, Godra, Puerto Rico also asked for a dusting of cannister. Tank No 17 fired a couple of rounds of cannister to the front of track No. 11, killing the attacking Viet Cong. Once again SSgt Catudan radioed for help. He was pleading, "Give me your cannister; they're still coming. Help me please!" SSgt Dokken fired one cannister round in answer to SSgt Catudan's call, when suddenly track No. 10 was hit by five mortar rounds, and burst into a ball of flames. SSgt Dokken said, "I could see people all around the track. I hoped the people around the track were the crew, so I couldn't continue firing there. I continued to fire on my sector of the western side of the perimeter." Track No. 10 continued to burn, while the wounded crew escaped. The crew of this track, No. 10 was SSgt Catudan, Sp4 Abke, PFC Steve Lopez, US56425384, Fremont, California, and Sp4 Ted Taylor, US64000372, Chinle, Arizona. PFC Lopez was evacuated and later died of his wounds in the hospital. Sp4 Taylor, wounded with shrapnel in the back, chose to remain on the battlefield and did not tell anyone he was wounded until daybreak. The track burned for 15 minutes and then exploded. It was then that track No. 17 sprayed the area with additional cannister.

At 0126 hours Captain Alcalá received permission to recall the already alerted 2d platoon from the ambush site to the beleaguered perimeter. Bravo and Charlie Troop elements, readied to fight, were ordered to move to Fire Support Base 14. At 0310 hours the 3-5 Cavalry squadron commander reported the following message to his 1st Brigade, which was also under the operational control of the 1st Infantry Division: "A Troop is being hit hard. Have just sent reaction force. Also, they are receiving heavy dismounted action."

As the 2d platoon, under the command of Lt Short, left the ambush site to go to the perimeter, they exploded their previously distributed claymores and trip flares. The tracks and tanks of the 2d platoon then headed south on Highway 13 to their troop perimeter at top speed. They put out continuous bursts of .50 calibre fire to ward off any would-be attackers. Lt Short said, "He didn't believe the VC fired on them on their way down the highway." The 2d platoon filled in the gaps in the hard pressed southern half of the perimeter.

Just prior to the return of the 2d platoon, track No. 34 at the northern portion of the perimeter was hit by a recoilless rifle round which penetrated the engine and entered the troop compartment wounding Sgt Robert A. Tydingco, RA50010144, Guam. His report to Lt Wolfe indicated that although the track had been hit it was still operative. Three minutes after track No. 34 was hit, track No. 36, with Lt Wolfe received a direct hit. Lt Wolfe said, "The shot hit my track in the rear, as I had previously turned the track to the northeast to get a better field of fire with my M-60 machine gun on the attacking VC troops. The round penetrated my track's right rear fender and left a big hole. By that time the VC were too close to my line of tracks, so I moved my line of tracks about 25 or 30 meters back toward the artillery positions." As the tracks moved back to realign the perimeter, track No. 16 remained stationary. He had lost communications temporarily. It was 0115 hours when the eastern half of the perimeter completed the realignment.

103

4

CONFIDENTIAL

III
CONFIDENTIAL

Lt Wolfe's track, No. 36, was hit again with an RPG-2 wounding the entire crew, including Lt Wolfe. The track had become tangled in the defensive barbed wire. The track entangled itself and was now given protection by tracks 33 and 35 on its flanks. Upon gaining its new position, the wounded were evacuated to the medical clearing tent that had been erected in the center of the perimeter. The center area provided enough clearance for a helicopter to land.

As soon as the 2d platoon secured their positions in the perimeter they were hit with recoilless rifle and grenade fire. Lt Short said, "When I pulled into position my platoon pulled into the south. Then I got a call from Captain Alcalá to move a couple of my elements to the north to fill a gap that existed there. I called my platoon sergeant to position the rest of the tracks. I took my tank, No. 27, and tank No. 29 to a position in the northeastern part of the perimeter facing north. Then I got a call from Captain Alcalá to extend the perimeter. I pulled my tank up about 35 to 40 meters due north. As I was moving forward the searchlight of tank No. 29 was hit by a recoilless rifle round. He continued to fire back at the Viet Cong, and while I was moving with him I was hit on the gunshield by a recoilless rifle round. The shock of the round knocked out the track driver as he halted the track. Two more rounds hit and penetrated the left side of the turret wounding the gunner, Sp4 Richard L. Hill, US54381969, Goldsboro, Texas."

Massive quantities of artillery fire were employed during the battle. Brigadier General Hollingsworth said, "We continued to press the attack with artillery from LAM KHE. We had a battery of 105mm howitzers, A Battery of the 7-9 Artillery, a corps artillery element; and a Battery of the 8-6 Artillery, from the 1st Infantry Division, which is a 155mm self-propelled artillery unit. During the preparation and firing of artillery into the enemy position, and the intensification of our own fires on the perimeter, we started setting up airstrikes. We called for the Air Force flare ship, commonly known as "Spooky." At the same time, we called in our own light fire teams to augment certain parts of the perimeter, and by about 0200 hours in the morning we had artillery covering the west and the southwest sides of the perimeter. We had gunships covering the east side of the perimeter."

At about 0145 hours, the 1st platoon of B Troop, 3-5 Cavalry arrived at the position. On their way down Highway 13, at 0143 hours, they blasted their way through an ambush hastily set up just north of the perimeter. The 3d platoon of C Troop, moving up from the south, also ran through a barrage of enemy fire before reaching the perimeter of Fire Support Base 14. Both cavalry units moved into the perimeter without suffering any damage or casualties.

The 3d platoon of C Troop was attached to A Troop at 0127 hours. At that time, Captain Alcalá had the platoon deploy on a cavalry sweep 1,500 meters south of the perimeter. They turned off Highway 13 and proceeded to the west in an echelon-right formation, firing north as they moved. The Viet Cong were using a sector of the old rubber plantation for assembly areas to concentrate their attacks on the perimeter. When the cavalry platoon moved into a position to block along the sector of rubber from the south toward the north, Captain Alcalá had the platoon sit in that position for about 20 minutes. Then he moved this armored force in a sweep through very light jungle to the west and then to the northwest to come around to a position that was 1,500 meters to the southwest or 7:30 o'clock from the perimeter. Again the armored force fired at the VC in the direction of the perimeter as they moved. While they were at this position southwest of the perimeter, airstrikes were due to come in and Captain Alcalá gave the platoon orders to double back and proceed to the southeast corner of the perimeter. This platoon closed into the perimeter area at 0220 hours.

104

5

CONFIDENTIAL

CONFIDENTIAL

112

When the B Troop element arrived, they moved around to the south, just outside of the perimeter, shooting as they went. Then they moved inside the perimeter and occupied positions between the A Troop vehicles on the western half of the perimeter from 6 to 12 o'clock. When the C Troop element closed the perimeter area they, too, swept around the area firing at the stunned Viet Cong as they moved. They then moved into positions between the A Troop vehicles on the eastern half of the perimeter, from 12 to 6 o'clock.

At this point the perimeter of Fire Support Base 14 contained B Battery, 1-7 Artillery, all of A Troop, 3-5 Cavalry, the 1st platoon of B Troop, 3-5 Cavalry, and the 3d platoon of C Troop, 3-5 Cavalry. This was a large amount of armor for the size of the perimeter, and Captain Alcala decided to expand the perimeter. The armored force all around the perimeter counter-attacked at about 0220 hours to regain the 40 meters that had been lost from the original perimeter.

The number 10 and 12 tracks had been burning all this time. Lt Festa moved forward with two M-113 tracks to evacuate the wounded men who were lying in a hole near the burning vehicles. During this time the southeast corner of the perimeter was under heavy attack. Lt Festa said, "On top of the burning armored personnel carrier I found three VC trying to get the .50 calibre machine gun off. I shot two of them, and Sp4 Abelardo Penedo, US66001401, Long Beach, California, on the No. 24 track told me he got the other one." As tracks No. 21 and 24 moved forward they saw five Viet Cong attacking the foxhole containing the wounded men from tracks No. 10 and 12. The attacking VC were immediately taken under fire and killed. Sp4 Penedo and Lt Festa jumped from their tracks and ran over to help recover the wounded. SSgt Minor was one of the wounded. He was placed inside Lt Festa's personnel carrier. The wounded were then taken back to the medics. This evacuation of wounded under fire began at about 0245 hours and lasted until about 0315 hours.

At the same time, the squadron commander, LTC Haszard, in an M-113 and followed by another M-113, moved up Highway 13 and drove into the heaviest part of the Viet Cong attack, where a seal of US artillery fire had been placed. As the squadron commander's track came within sight of the perimeter, his vehicle was struck by either an artillery or a recoilless rifle round. The round knocked out his engine and killed his right gunner. Two minutes earlier LTC Haszard had been acting as the right gunner.

Captain Alcala, on seeing the squadron commander's track stopped by a direct hit, sent a tank, No. C-37, forward to assist in the recovery of the damaged M-113. Brigadier General Hollingsworth observed the action and said, "LTC Haszard performed a very gallant act under fire when he dismounted his vehicle and proceeded to move the escort vehicle into position to tow his damaged vehicle into the perimeter. I discussed with him at that time the importance of his getting into the perimeter and getting tied in with the A Troop commander. Communications at this time are very vital to the success of a battle, and I was particularly interested in his getting inside the perimeter so that in case the troop commander's communications were knocked out, I would still have communications with the forces on the ground."

When LTC Haszard's track was knocked out between the perimeter and the road, he didn't believe the VC were as close to the perimeter as they actually were. Even Captain Alcala didn't believe the Viet Cong were near the area where the squadron commander's track was stopped. Captain Alcala's cannister rounds, machine guns, and high explosives had been pounding that area for about two hours. When LTC Haszard dismounted his track there were VC in his immediate area which he had to ward off before he could hook his vehicle to the tow line.

6

105

CONFIDENTIAL

CONFIDENTIAL

Just before the squadron commander got his command track and group into the perimeter, Lt Short's No. 27 tank took a hit from a recoilless rifle round which penetrated the turret, killing his loader, PFC James Haggard, RA25515472, Louisiana, and throwing Lt Short out of the tank. Lt Short said, "I climbed back up on the tank, but I couldn't get my driver, Sp4 Kenneth Miller, US55869005, Flint, Michigan, to answer; so I went up to the front of my tank to try to talk to him. While I was standing there the No. 29 tank to my left called on the radio to my driver and told him to back up. We then backed up the tank to a position beside the medic's track. Sgt Stevens got off No. 29 track while Sp4 Penedo came over to help me pull my loader out of the turret. After I got the rest of the crew out of the tank I spent about 15 minutes or so carrying the wounded from No. 44 track to the dust off area. Penedo and I got back on No. 27 track and blasted away at the VC. Sgt Stevens, whose wounds were unknown to me at the time, got back onto his No. 29 tank. After I moved my tank back into the fight I didn't receive any more enemy rounds. The fighting to the south was quite heavy now."

Another VC round hit and glanced off the No. 38 tank of SSgt George Hua, SSgt Douglas B. Casey, RA54052578, Shreveport, Louisiana said, "I told my driver to shift over to cover tank No. 38's position and to move us into direct line with the VC gunner. The tanks blasted away at the VC anti-tank position. Then tank No. 38 took another hit which took the .50 calibre machine gun out of SSgt Hua's hands. SSgt Hua then returned back to his cupola and told me he was okay. We both fired at the VC recoilless position and knocked it out." The time was now about 0300 hours and the VC commenced another attack in the southern sector of the perimeter.

It appeared to Captain Alcalá and his troops that this attack was an attempt to recover VC bodies. They noted that the VC troops were attacking in a line of skirmishers, but immediately behind them were unarmed troops with ropes and wire with hooks to recover the bodies left on the battlefield. The attacking enemy force got almost as close as on the other attacks before being stopped about 15 meters in front of the perimeter. Again, the attacking VC got too close for Lt Wolfe's platoon to continue to deliver effective fire with their tank guns. So again, the line was pulled back on the east side of the perimeter 20 meters, and, again, after the VC were killed the line was reorganized and the original positions retaken.

During this attack at 0300 hours, airstrikes and "dragon ships" were employed on the attacking Viet Cong. The airstrikes were to continue to pound the Viet Cong positions until about 0700 hours that morning. According to Captain Alcalá, "The initial airstrikes were from south to north on the east side of Highway 13. It appeared at that time that the source of the attacks was in the east to northeast side of the highway. There was a berm by the road and a railroad bed that was used for cover and concealment by the VC. Also there was good jungle foliage for concealment, and there was a creek bed which the VC could use for limited cover. Subsequent airstrikes hit the rubber tree line to the south of the perimeter. The later attacks actually broke up the Viet Cong attacks and caused the enemy to stop attacking and fall back in the southeast. In other places along the 360 degree perimeter the Viet Cong could not easily fall back because of the large amount of open space they had to cross. As a result, those VC who tried to withdraw in the west, north, and northeast were cut down by the large volume of fire directed on them. The southeast corner offered them the only good route of withdrawal. After about 30 minutes of airstrikes on the north-south axis east of the perimeter, the airstrikes shifted to an east-west axis south of the perimeter and continued there until 0400 hours.

CONFIDENTIAL

CONFIDENTIAL

114

During the battle, resupply and dust off missions were made by the 1st Infantry Division operations center under the direction of LTC Paul F. Gorman, 062379, Assistant Chief of Staff, G-3, 1st Infantry Division. Also, during a battle of this scale, the .50 calibre and 7.62mm machine guns expend ammunition very heavily. Lt Wolfe said, "My ammo was getting low at around 0345 hours. I had about 700 rounds of .50 calibre ammo, and about 1,000 rounds of 7.62mm ammo left after the main assaults were beaten back. I had originally a triple basic load and had fired over two loads. The VC had backed off in other sectors of the perimeter, but they had not done so in my sector, as the ground to the southeast had many holes and dips which made movement in this sector easiest for them. Also we now occupied the weakest part of the perimeter, as all of my tracks had been hit and almost all of our weapons were not functioning."

Just prior to 0445 hours, the resupply and evacuation of the wounded was completed. "At about 0330 hours in the morning the VC fire slackened off to the point that I felt that I could first get the wounded out," said Brigadier General Hollingsworth. The general went on to say, "I want to state that one of the important points in this battle was that the artillery and the airstrikes continued during the evacuation of the wounded. Of the 63 men wounded we evacuated 26. Many soldiers were only slightly wounded, and they chose to stay in their positions manning their weapons during this battle. In the meantime, my judgement indicated, from past experiences with the VC, that there is no question that this was a regimental size attack."

At 0500 hours the Viet Cong began to launch their final attack, from the south and southeast. At that time, a CBU airstrike by F-100's started to come in from east to west in the area south and southeast of the perimeter. At the same time, the artillery continued to fire east of the 84 grid line. Following the CBU attack a napalm airstrike was placed in the same general area. Artillery fire was also shifted to fall to the north of the perimeter, to cover possible escape routes northeast of Highway 13 along the railroad tracks, the stream bed, and the trail.

At 0500 hours the airstrikes were brought back into the area to break up the concentration of VC troops in the rubber trees. Realizing that the VC were assembling in the rubber for a final assault, Brigadier General Hollingsworth asked LTC Gorman to stack at least four flights of air support to be ready on station at 0500 hours. During the night the general planned to move the air attacks from the east across to the southern part of the sector, bringing in napalm and CBU. The general then planned to move them across the southwest and finally, work CBU, napalm, and bombs along the western sides of the sector, while moving the artillery further to the west into an area to which he expected the VC to withdraw. The general said, "I chose to move the airstrikes at 0450 hours. I shifted the artillery to the west, and I began the airstrikes across the southern part of the perimeter with the idea in mind that I'd move them to the southwest and then to the west. It just so happened that the final assault of the VC started at 0500 hours. With the assistance of flares and tank searchlights that were shining in the area, we could see the assault mounting. Thirty seconds away from the area in which the final assault was to occur and did occur were two F-100's ready to deliver CBU. As the VC got up to make their final assault, they were met by the CBU from the F-100's."

Captain Alcalá and Lt Wolfe saw one of the F-100's making a pass from east to west. Lt Wolfe said, "I saw the CBU explode while he was on top of it. He probably released it too soon." Captain Alcalá said, "He tried to gain altitude by banking to the left and then up. The aircraft went into what looked like a stall position when his engine quit. He then crashed."

107

8

CONFIDENTIAL

115
CONFIDENTIAL

It Wolfe said, "During the CBU attack the F-100 that crashed made his run at an altitude of only 50 feet above the trees. Brigadier General Hollingsworth's comment was, "We lost in the battle one F-100, and I am not certain whether the aircraft was shot down or it developed some mechanical problem. The final assault on the VC, however, was ended, and the small arms fire from the VC ceased. The battle was now left to the airstrikes and the artillery fire."

The F-100 crashed 2,000 meters east-southeast of Fire Support Base 14's perimeter at coordinates XT830447. At about 0815 hours C Troop, 1-4 Cavalry tried to land their helicopters at the crash site, but heavy enemy ground fire forced their helicopters to take altitude without grounding the troops. Observations made by D Troop 1-4 Cavalry personnel were that the F-100 pilot's parachute opened when he hit the ground. At about 0900 hours, after a light fire team had worked over the area, the troops landed at the crash site and recovered the dead pilot's body.

At 0700 hours the final airstrike was placed on the withdrawing Viet Cong. Brigadier General Hollingsworth then landed at Fire Support Base 14 and met with LTC Haszard. Instructions had already been issued to the cavalry at Fire Support Base 14 to move out at daybreak to attack in order to pick up the wounded, the prisoners, the abandoned weapons, and to count the dead. At 0947 hours C Troop 1-4 Cavalry went under the operational control of the 1st Brigade, 9th Infantry Division, which at the time of this battle was under the operational control of the BIG RED ONE. C Troop 1-4 Cavalry then assumed the mission of A Troop 3-5 Cavalry.

After the battle was over, LTC Haszard delivered to the men who had taken part in the battle the following message, "I am extremely proud of every man in this unit for their actions last night. However, there are still many VC in the area. Therefore, you must take all precautions. I want you to have reaction forces ready for all elements in the way that you did today. I must have any weapons that have been claimed as souvenirs. They will be returned, I promise. Sweep operations tomorrow must be done thoroughly. Insure that perimeters tonight are the best possible."

After the battle was over, at 1210 hours, Brigadier General Hollingsworth gave the following message to the 1st Division G-5: "Print up news leaflets addressed to Commanding General, 9th VC Division telling him that his battalion commanders and regimental commanders of the 273d VC Regiment have left the battlefield covered with dead and wounded and that we don't consider this very soldierly. We intend to bury his dead for him, but wanted him to know what his commanders did, so he can take disciplinary action." Brigadier General Hollingsworth knew that the VC have self-criticism programs, and they discuss such things as how well the battalion commander, the company commander, and the political officers have performed in battles. During Operations CEDAR FALLS and JUNCTION CITY, he noticed that several battalion commanders had been reduced in rank along with the political officers because they had left dead and wounded on the battlefield.

Results:

The Battle of AF BAU BANG II resulted in the following losses: 22 VC KIA (BC), and 3 VC WIA captured. Captured enemy equipment included: 1 Chicom type 57 machine gun, 1 Chicom type 58 machine gun, 1 Chicom type 56 machine gun, 1 Chicom type 50 sub-machine gun, 2 Chicom 56 rifles, 2B-40 rocket launchers, 1 US BAR, 2 AK-47's, 74 Chicom grenades, 1,185 crimp cartridges, 33 rifle grenades, 1 US grenade, 37 K50 magazines, 8 BAR magazines, 19 AK-47 magazines, 10 B-40 rockets, 2 57mm rounds, 3 75mm rounds, 9 drum magazines for Chicom 58, 1 base plate 60mm mortar, 2 lbs TNT,

108

9

CONFIDENTIAL

CONFIDENTIAL

116

16 hammocks, 3 VC gas masks, 26 canteens, 7 ponchos, 1 lantern, 2 machetes, 1 grappling hook with a 50 foot rope, 1 US bayonet scabbard, 10 pistol belts, 1 field pack, 18 entrenching tools, 3 picks, misc individual clothing, and 15 lbs of documents. Destroyed enemy equipment was 1 B-40 rocket launcher, 1 TA-312 telephone, 1 B-40 round and 231 uniforms.

Captured enemy prisoners identified the attackers as the 2d and 3d Battalions of the 273d VC Regiment and one local guerrilla company. US intelligence believes that the entire 273d Regiment took part in the attack on Fire Support Base 14.

Friendly losses during the battle were 3 US KHA and 63 US WHA (26 evacuated). Friendly equipment destroyed was 1 M-113 and 1 M-106. Friendly equipment damaged was 5 M-48A3 tanks and 11 M-113 APC's.

In support of the US forces in Fire Support Base 14 was an overwhelming amount of artillery and airpower placed on the attacking VC forces. There was a total of 29 sorties flown, dropping 25 tons of ordnance on the Viet Cong. The artillery fired 2,148 rounds of 105mm, 688 rounds of 155mm, 39 rounds of 175mm, and 69 rounds of 8 inch howitzer ammunition.

The following statistics reflect the amount of ammunition expenditure of the 3-5 Cavalry elements at Fire Support Base 14 during the battle:

<u>A Troop 3-5 Cav</u>	<u>1st Platoon C Troop 3-5 Cav</u>
1. 30 trip flares	1. 20 rds 4.2" illum.
2. 40 claymores	2. 15 rds 90mm cannister
3. 2,000 rds .45 cal	3. 4 rds 90mm HE
4. 600 rds 40mm M-79	4. 5,000 rds .50 cal
5. 34,000 rds .50 cal	5. 18,000 rds 7.62mm
6. 42,000 rds 7.62mm	6. 8 white flares
7. 19 rds 4.2" illum.	7. 12 fragmentation grenades
8. 10 rds 4.2" WP	
9. 6,880 rds 5.56mm	<u>1st Platoon B Troop 3-5 Cav</u>
10. 60 rds 90mm cannister	1. 105,000 rds .50 cal
11. 20 rds 90mm HE	2. 2,000 rds 7.62mm
12. 1 rd 90mm HEAT	3. 7 rds 90mm WP
	4. 29 rds 90mm HE
	5. 54 rds 90mm cannister
	6. 2 bases M-79 rds
	7. 1 case 5.56mm ammo

analysis:

Brigadier General Hollingsworth gave the following summation of the action: "The 3-5 Cavalry had been in-country only about two or three months, and the battle at BAU BANG proved to be a very fine action on the part of the new unit. It was their first major battle. We found when we examined the documents on the dead and interrogated the wounded prisoners that, as I had suspected, the attacking VC force was the 273d VC Regiment. I understand that the G-2 has now identified all three of the battalions.

The problems we had during the battle were not unusual ones. We had some trouble with communications, which are vital. Though our casualties were light, we encountered a few problems in redistributing the platoons and the tanks to fill the holes that occurred in the line. I think that only three of our men were killed, and about 63 wounded, of which we had to evacuate only 26.

109

10

CONFIDENTIAL

117

CONFIDENTIAL

There are three factors which accounted entirely for our success in this battle. First, there is the great bravery and the courage of the young American draftee-soldier to stand and fight. Second, there is the massive use of artillery. Third, there is the massive, accurate, and devastating use of tactical air support. There is no question in my mind that battles here are won because of the massive use of artillery and tactical air support. I think that in this type of battle, more VC are killed by machine gun and small arms fire when they attack a cavalry unit than if they had been attacking an infantry unit. This is understandable because we have a greater number of machine guns in a cavalry troop."

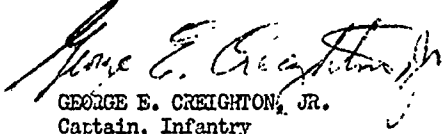

GEORGE E. CREIGHTON, JR.
Captain, Infantry
Commanding

2 Incl

1. ~~Map Sheet 6331 IV S (Series 18020) W. H. Brown, HQ - VA~~
2. Battle Sketch

110

CONFIDENTIAL

CONFIDENTIAL

118

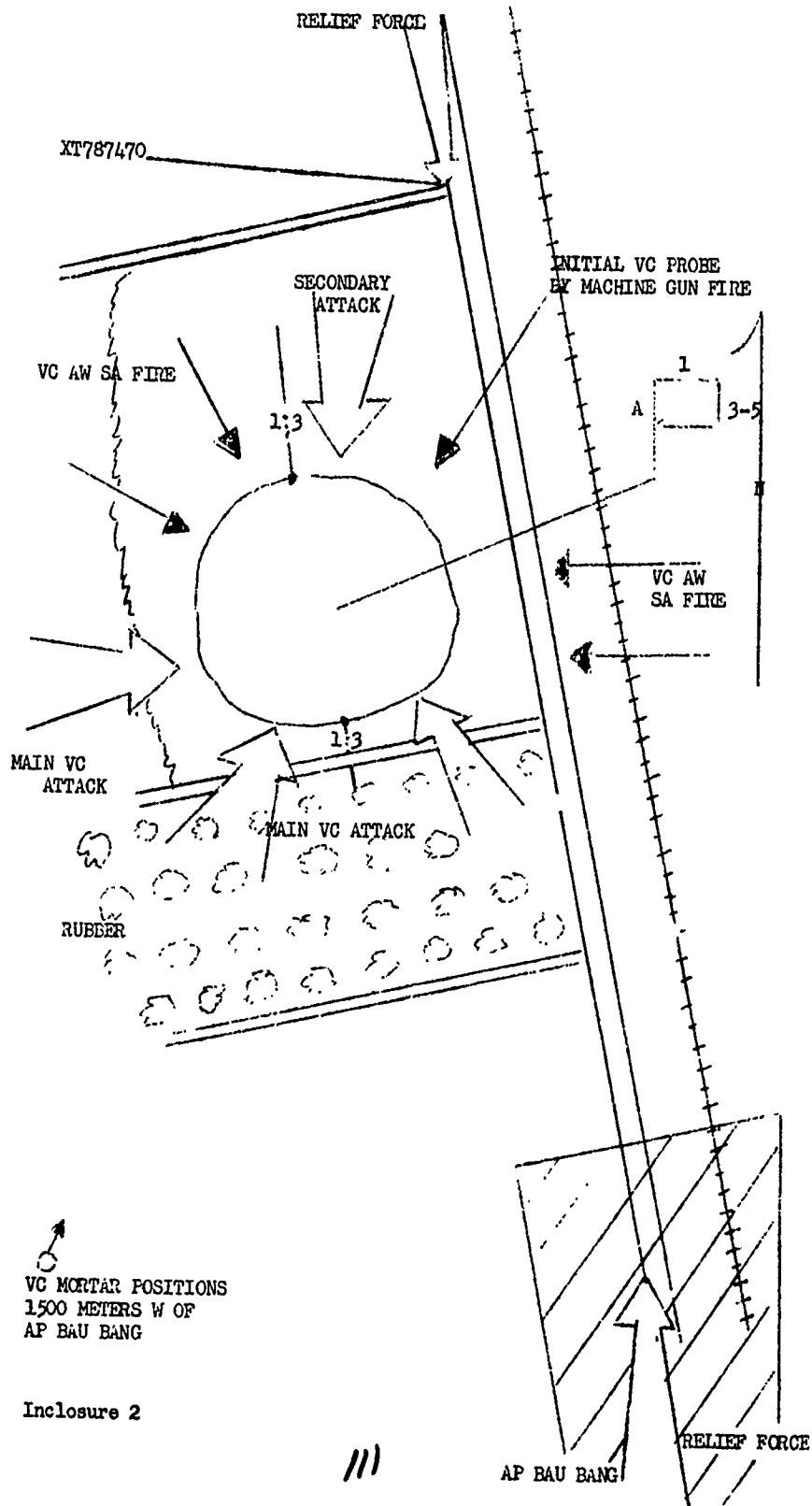

CONFIDENTIAL

119

CONFIDENTIAL

DEPARTMENT OF THE ARMY
HEADQUARTERS 1ST INFANTRY DIVISION
17th Military History Detachment
APO San Francisco 96345

AVDB-T

4 August 1967

The Battle of PREK KLOK I
28 February 1967

Background:

On 23 February 1967, during Operation JUNCTION CITY, the 1st Battalion, 16th Infantry commenced an air movement from LAI KHE to SUOI DA at 1530 hours by C-123 aircraft. The last lift landed at 1740 hours. The battalion occupied a base camp position near the Special Forces camp at SUOI DA during the night of 23-24 February 1967. At 0300 hours 24 February the battalion was mortared by about 120 rounds of 82mm VC mortar fire. The result of the attack was 2 KHA and 4 WHA. Counter mortar fires were placed in the general area of the mortar attack, to the northeast, with unknown results.

On 24 February at 0900 hours A Company 1st Battalion, 16th Infantry landed by helicopter in LZ APPLE (XT268480), and at 1010 hours the battalion minus landed in LZ PEACH to secure route TL 4 in sector for resupply convoys. A Company, 1st Battalion, 16th Infantry established a night defensive position in LZ APPLE with the 3d Platoon, C Troop, 1st Squadron, 4th Cavalry attached. Headquarters and Headquarters Company 1st Battalion, 16th Infantry moved north by vehicle to establish a night defensive position at LZ PEACH. B Company, 1st Battalion, 16th Infantry moved north on a parallel course to route TL 4 to establish a night defensive position with Headquarters and Headquarters Company, 1st Battalion, 16th Infantry. During the night of 24-25 February the battalion conducted 5 squad size (reinforced) ambush patrols. An ambush patrol from A Company made contact at coordinates XT273746 at 1900 hours and suffered 3 WHA. Fire was returned with unknown results.

During 25 February the battalion cleared and secured route TL 4 in their sector with A Company to the north, B Company in the center, and C Company to the south. Four platoon size combat reconnaissance patrols were conducted in the sector. During the day B Company reported on VC in the vicinity of coordinates XT274722 and placed small arms, mortar, and artillery fire into the area with unknown results. At 0850 one VC hit a truck in a convoy at XT273720 with an RPG round. B Company, C Company and the Reconnaissance Platoon dispatched a patrol to get the VC. Their attempts were unsuccessful. All patrols returned to their units by 1600 hours and the battalion moved into night defensive positions at 1645. "Stay-behind" ambush patrols were left at critical points along the road. During the night the attached cavalry platoon moved up and down the road. There were no enemy contacts during the night.

On 26 February 1967 the 1st Battalion, 16th Infantry secured route TL 4 in sector with B Company to the north and C Company to the south. A Company conducted a combat reconnaissance patrol to the east resulting in no enemy contact. During the night no enemy contact was made.

On 27 February 1967 A Company secured the northern half of the route TL 4 sector and B Company secured the southern half. C Company with a platoon from A Company and the Reconnaissance Platoon conducted an air-mobile assault at XT301774 at 0930 hours. The two platoons secured the

112

CONFIDENTIAL

CONFIDENTIAL

120

LZ while C Company conducted search and destroy operations to the southwest of the LZ. No enemy contact was made during the day and the force was extracted from the LZ at 1635 hours. No enemy contact was made during the night.

28 February 1967:

On 28 February 1967 A Company secured the northern half of route TL 4 and C Company secured the southern half of the sector. At 0715 hours 28 February 1967 B Company departed the battalion night defensive position located at XT273726 on a company size combat reconnaissance patrol. The company mission was to patrol to the east and destroy VC hard installations and personnel in the area. The company moved from its night defensive position along a cleared section of the road for approximately 400 meters. The order of march was 3d Platoon, 2d Platoon and 1st Platoon. The platoons were each organized into two single-file columns. One fire team consisting of a team leader and three riflemen from the 3d Platoon was at the point. The company headquarters was located between the 2d and 1st Platoons. The weapons squad was at the rear of each platoon under the control of the platoon leader.

The weather was clear, hot, and dry. The jungle was extremely thick, and, consequently, movement was excessively slow. At times the jungle growth would become less thick permitting faster movement and a greater dispersion of troops.

At Check Point 1 (XT274723) the company changed direction and moved on an azimuth of 65 degrees for approximately 900 meters. During this phase of the march each platoon employed two riflemen 10-15 meters to each flank for security. Marching conditions began to improve considerably as the jungle became less thick. Trees were spaced 10 to 15 meters apart and varied in height from 100 to 150 feet. Numerous smaller trees were growing between the larger trees, but the lack of thick undergrowth was very noticeable. The only obstacle to movement was the considerable deadfall which was encountered every 50 to 75 meters. Platoon columns were spaced approximately 30 to 35 meters apart due to the increased visibility afforded by the terrain. The men had been advised to look into the trees ahead and to try to spot snipers; however, the general tendency is to look towards the horizon and not overhead. No enemy contact was made during this phase of the patrol.

After reaching Checkpoint 2 (XT282726) the company halted and conducted "cloverleaf" patrols. While cloverleafing the 1st platoon discovered a partially completed hut and what appeared to be fresh footprints on a north-south trail which was approximately 49 meters to the south of the platoon's patrol base. The platoon continued to conduct cloverleaf patrolling in the area for about 20 minutes. There were no further significant observations of enemy activity in this phase of the patrol. The terrain continued to be similar to that previously described.

At 0930 hours the company proceeded to move along uneventfully on the same azimuth for a distance of approximately 900 meters. The order of march remained the same. At 1010 hours the company halted and began cloverleaf patrolling for about 15 minutes. A well used southeast-northwest trail was discovered approximately 50 meters south of the company. During this period the company received a location fix from the air that placed them at Checkpoint 3 (XT287726). This location fix was confirmed by reports of artillery fire on the southern flank of the company. At 1025 hours the company continued the march using the same march formation. There were no unusual sounds or observations.

CONFIDENTIAL

2

113

121

CONFIDENTIAL

The Battle:

At 1030 hours the lead element of the 3d Platoon (the company point platoon) at coordinates XT288727 was brought under fire by an undetermined amount of small arms and automatic weapons fire coming from their front (east). SGT John H. Worthington, RA18712959, Houston, Texas said of the action, "I was the Alpha Team Leader, 2d Squad, 3d Platoon. We had just finished cloverleafing and were on our way to our third checkpoint when we heard the point being taken under fire. We hit the ground and a medic came up to my position. We then laid down a base of fire, and I moved up the center of the platoon. There was alot of snipers and they shot at anything that moved. Three men and I set up a small perimeter in the center of the platoon after I learned that the platoon leader and all of the squad leaders were dead or wounded."

The lead platoon reported to the Company Commander, CPT Donald S. Ulm, 094149, that it thought the size of the enemy force was a company. The point element was completely engulfed by enemy fire power to the front, suffering heavy casualties. The 3d Platoon was receiving heavy enemy fire, too. Three enemy machine guns were observed to the front and CPT Ulm decided that the enemy force was larger than a company size unit. The enemy machine gunners were observed crawling forward with their guns while being covered by a base of fire from their left and right front. CPT Ulm said, "The VC were well concealed but not dug in. They really weren't ready to ambush a company size unit. I think because we were spread out so much that the VC thought we were a platoon and rather than run they thought they would eliminate us. The 3d Platoon continued to receive heavy fire and was unable to gain fire supremacy. The three enemy machine guns were knocked out three times and each time a new VC took over each of the guns." After three or four minutes the enemy fire decreased to well aimed small arms fire.

At 1035 hours the 3d Platoon reported being attacked on their right flank (south) as well as receiving small arms fire from the front (east). SGT Worthington said, "At this time a group of VC tried to charge our positions but we shot a lot of them down. They tried to flank us on the right and then on the left while they maintained their heavy volume of fire at us. We could hear the VC moving all the time but we could not see them. Only their tree snipers could see us."

The 2d Platoon was maneuvered to the right flank of the 3d Platoon without coming under enemy fire. The 2d Platoon tied in with the extreme right flank man of the 3d Platoon. Once the 2d Platoon was in position they received a heavy volume of small arms and automatic weapons fire. They also heard enemy troops moving along the platoon's front toward the west. The platoon immediately returned the enemy fire.

At 1040 hours airstrikes and massive artillery fire were placed on the east, north, and south of the beleaguered company. CPT Ulm said, "As the airstrikes started to come in I called for smoke and it seemed as though everyone who had a smoke grenade threw it to his front. The CBU attack came in close on our southern flank and was extremely effective in killing VC, especially on our southern flank."

SSG Francis Stephens, RA12353050, Aurora, Colorado said, "The airstrikes and artillery started 300 meters out from us and came in to about 25 meters. The fires landed right on top of the VC. There were many VC firing at us from trees. As one of us would move, the VC would fire at us. To counter these tree snipers we worked in teams with one man moving his head or hand and another man watching to see where the enemy fire was coming from and return it immediately. When we killed the VC in the trees we wondered why they didn't fall to the ground. After the battle we

CONFIDENTIAL

3
114

CONFIDENTIAL

122

found a lot of dead VC who had tied themselves to their trees. You could not really see the snipers so we placed machine gun fire into the trees. This was very effective."

At 1050 hours the enemy began to attack from the northeast. Contact was lost with the 3d Platoon and possibly the 2d Platoon would be flanked from the direction of the renewed attack. To counter the new threat CPT Ulm maneuvered his 1st Platoon to the northeast. As the 1st Platoon began to move, the entire company area was hit with what appeared to be rifle grenades, RPG rockets, and 60mm mortar rounds. Very few casualties were inflicted by these weapons. The 1st Platoon continued to move to the left (northeast) under enemy fire, and they moved into position on the left flank of the 3d Platoon. Physical contact was not made with the third platoon at this time due to the intense fire still being placed into the 3d Platoon area.

At 1230 hours radio contact was reestablished with the 3d Platoon. The company was in a roughly horseshoe-shaped perimeter with the 3d Platoon in the center (east), the 2d Platoon on the right flank (south), and the 1st Platoon on the left flank (north). The enemy continued to place intense fire on all sides of the company, shifting from left to right. CPT Ulm realized at this time that much of the automatic weapons and small arms fire was coming from the trees on all sides of the company positions. This fire was extremely accurate and proved to be devastating. The snipers were expertly camouflaged and well trained to take advantage of the natural concealment. The company's efforts were now directed toward killing the VC in the trees. Although many of the snipers were killed by small arms, artillery, and airstrikes, their threat was never completely eliminated. At 1300 hours the 2d Platoon heard movement to the west and it appeared that the enemy was attempting to encircle the company and attack the open end of the horseshoe-shaped perimeter from the west. To counter this threat a fire team from the 1st Platoon was placed on the northwest and a squad from the 2d Platoon was placed on the southwest. As the squad on the southwest moved into position they received heavy automatic weapons fire from the trees to the west. The squad returned the fire and placed effective, well aimed fire on the enemy to the west. Artillery fires were called in on the western side of the company, and the threat from the west appeared to be eliminated. The enemy continued to fire into the platoon positions with heavy volumes of fire until 1400 hours, at which time the enemy effort subsided into a selected sniper program. By 1500 hours all enemy contact was broken. Airstrikes and artillery continued to pound the area. At 1530 hours the 3d Platoon observed several VC returning to gather their abandoned weapons. These VC were immediately killed by the remaining 3d Platoon riflemen.

At 1600 hours a reinforced rifle company, B Company, 2d Battalion, 18th Infantry and the Commanding Officer, 1st Battalion, 16th Infantry, LTC Rufus C. Lazzel, 064634 linked up with B Company, 1st Battalion, 16th Infantry. The newly arrived force provided security, assisted in the evacuation of the dead and wounded, and policed the battlefield.

At 1930 hours all of the friendly elements moved to a newly established 1st Battalion, 16th Infantry night defensive perimeter at XT29727. B Company, 1st Battalion, 16th Infantry was secure within friendly lines by 2030 hours. There were no US dead, wounded, or weapons left on the battle area.

Intelligence from captured documents revealed that the enemy unit involved in this contact was the 3d Battalion of the 101st North Vietnamese Army Regiment.

CONFIDENTIAL

4

115

CONFIDENTIAL

123

Results:

US
KHA 25
WHA 27

VC
KIA 169 (BC)
Equipment captured: 40 Russian carbines,
2 RPG-2's, 2 AK-47's, 1 Chicom machine
gun, 1 Chicom light machine gun, 1 US
M-1 rifle, 1 Russian sub-machine gun.

1 Incl
Sketch of Battle Area

George E. Creighton, Jr.
GEORGE E. CREIGHTON, JR.
Captain, Infantry
Commanding

CONFIDENTIAL

116

5

CONFIDENTIAL

124

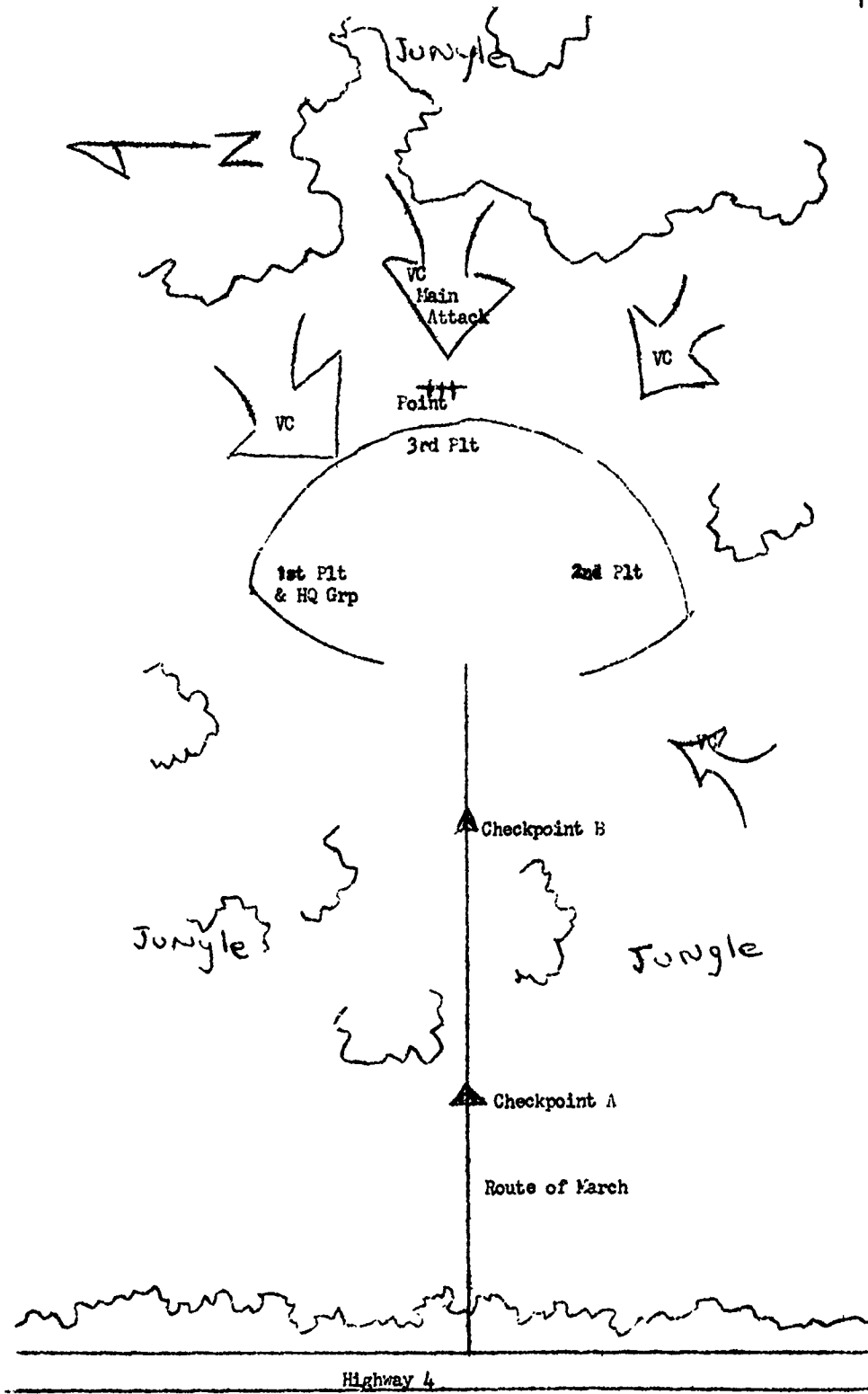

CONFIDENTIAL

117

del 1

125

DEPARTMENT OF THE ARMY
HEADQUARTERS 1ST INFANTRY DIVISION
17th Military History Detachment
APO San Francisco 96345

AVDB-T

4 August 1967

The Battle of PREK KLOK II
10 March 1967

On the evening of 10 March 1967 during Operation JUNCTION CITY, the 2d Battalion, 2d Infantry Mechanized (-) under the command of LTC Edward J. Collins of San Antonio, Texas, was securing the perimeter of Artillery Fire Support Base (FSPB) II, located in TAY NINH Province near the PREK KLOK stream. Inside the "wagon train" style perimeter of FSPB II were Headquarters and C Batteries, 2d Battalion, 33d Artillery, and elements of the 168th Engineers.

The 2-2 Infantry's M-113's were placed at 50 meter intervals around the base perimeter. The intervals between the tracks were protected by foxholes, manned by infantrymen, engineers, and artillerymen.

As dusk fell all was quiet at Fire Support Base II. The troops on the perimeter fired a "mad minute" at 1900 hours to test their weapons and to ward off would be attackers. Upon completion of the evening "mad minute" ambush patrols and listening posts departed the perimeter.

At 2026 hours a listening post from A Company, 2-2 Infantry reported seeing 3 Viet Cong while moving into position. The Viet Cong were engaged by the listening post with small arms with unknown results. As a result of this contact the listening post was displaced, having accomplished its early warning mission. The battalion was placed on 75% alert as pre-planned artillery destruction fires continued.

At 2208 hours the Viet Cong commenced a heavy mortar attack on FSPB II. For approximately 30 minutes the Viet Cong fired a barrage of about 200 rounds of 120mm, 82mm, and 60mm mortars located 1700 meters to the east of the perimeter. In addition to the incoming mortar rounds the Viet Cong fired 75mm recoilless rifles at the perimeter. The VC had the perimeter targeted as the rounds landed inside the perimeter and struck several tracks. 4.2" mortars commenced a counter-mortar fire program within two minutes of the initial attack. As a result of the mortar attack, a score of US troops were wounded. Cooks, maintenance crews, and medical personnel began carrying the wounded to the airstrip resupply point where helicopters removed them and resupply missions could be accomplished.

During the mortar attack Major Frederic J. Brown, Wellesley, Massachusetts, moved from a position of cover into the impact area of the enemy mortar rounds to determine the location of the enemy positions by crater analysis and to direct friendly fire on them. Throughout the mortar attack and the ground attack which followed Major Brown stayed in this dangerous position, silhouetted by illumination rounds, in order to accomplish his purpose. He was later presented the Silver Star for his gallantry.

126

As soon as the mortar barrage ended LTC Collins directed all his units to conduct a "reconnaissance by fire" of the area 200 to 600 meters beyond the perimeter. This was done with fire from Caliber .50 machine guns mounted on the tracks and from ground mounted positions. Individual weapons were fired from the foxholes.

The reconnaissance by fire had no sooner ended than the enemy launched a ground attack at 2220 hours along the East sector into the positions held by A Company 2-2 Infantry. "The VC got quite close to us. At one point, I had to get up and throw a grenade at three of them that were trying to set up a recoilless rifle not far from one of our tracks", SSG Richard Rousseau, Winston, Massachusetts, a squad leader in A Company later recounted.

Among those firing the track mounted machine guns and small arms -- now not in reconnaissance but in defense -- was SSG Richard A. Griffin of A Company. During the mortar attack, SSG Griffin had run from his sheltered position to resupply his comrades along the perimeter with ammunition. When the ground attack began, he returned to his machine gun and placed a heavy volume of accurate fire on the enemy. He was later awarded the Bronze Star with "V" (for valor) Device.

The beleaguered units of FSPB II immediately called the 3d Brigade Forward Headquarters at SUOI DA and requested close tactical air support, artillery, medical evacuation for the wounded and an ammunition resupply. The response to these requests was immediate. Medical evacuation and resupply were provided with the dispatch of 5 UH1D aircraft that flew 26 sorties under fire. With their landing lights on, these aircraft brought in over 11 tons of resupply. Air Support was provided by 100 sorties of TAC air.

In addition to the main attack from the east, the enemy also launched less forceful attacks from the northeast and southeast. Sp 4 Thomas Lark, Louisville, Kentucky, a truck driver with C Company, 2-2 Infantry, was in a foxhole on the southeast side. "We had listening posts (LPs) and trip flares about 50 meters out. When the VC hit our trip flares, after our LPs had been withdrawn, they stayed out to our front during the mortar attack; we opened up on the VC and after that we never had any trouble with the VC getting close to our perimeter. We had dug pits and put our tracks down in them so they couldn't be hit very easily. Because of this and our placing of flares a good distance from our lines, we prevented the VC from even getting close."

Intense fire from recoilless rifles and automatic weapons was being delivered against A Company on the eastern side of the perimeter. A Company bore the brunt of the attack as three M-113 armored personnel carriers were hit by RPG-2s, and one M-113 received a direct hit from a mortar round.

On the southwestern side of the perimeter, C Company received the brunt of the secondary attack. Moving parallel to Highway 4A on the western side of the road the Viet Cong made a rush across 500 meters of open ground to hit C Company's positions. Continuous fire quickly gained fire superiority over the enemy. C Company never reported sighting more than a platoon of VC in the clearing, although many more VC fired from the woods.

As the mortar attack started and small arms fire was being received, the artillery defensive concentrations were being requested. The entire perimeter was then covered by a massive amount of artillery fire as Forward Observers made adjustments toward the enemy attacks. Nearby artillery units and the artillery in FSPB II swept the area around the perimeter with 5,000 rounds of artillery, while the 3d Brigades Forward Air Controllers directed 100 sorties of TAC air strikes to the east and southeast.

119

122

An armed C-47 airplane called "Spooky" also trained its mini-guns on the VC forces to the east of the perimeter. As air support arrived at the scene of the battle Highway 4A was declared a Fire Coordination Line, between the artillery and the Air Force. To the west the artillery broke the enemy's assault and prohibited them from regrouping. To the east the Air Force took over from the artillery and covered the area with bombs, rockets, and 20mm cannon fire. The massive and devastating use of airstrikes and artillery broke the back of the enemy attack.

By 2330 hours the brunt of the attack had been repelled; however sniper fire continued to be received as the VC withdrew. The last enemy round fired in the battle was fired at 0428 hours. The early morning sweeps and aerial observation of the battle area resulted in finding 197 VC KIA, and 5 wounded VC PWs, US losses were 3 KHA and 41 WHA.

- 2 Incl
1. Diagram
2. Map Sheet 6232 III S
(Series 18020) Withdrawn
dtc DA

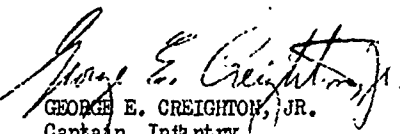
GEORGE E. CREIGHTON, JR.
Captain, Infantry
Commanding

120

128

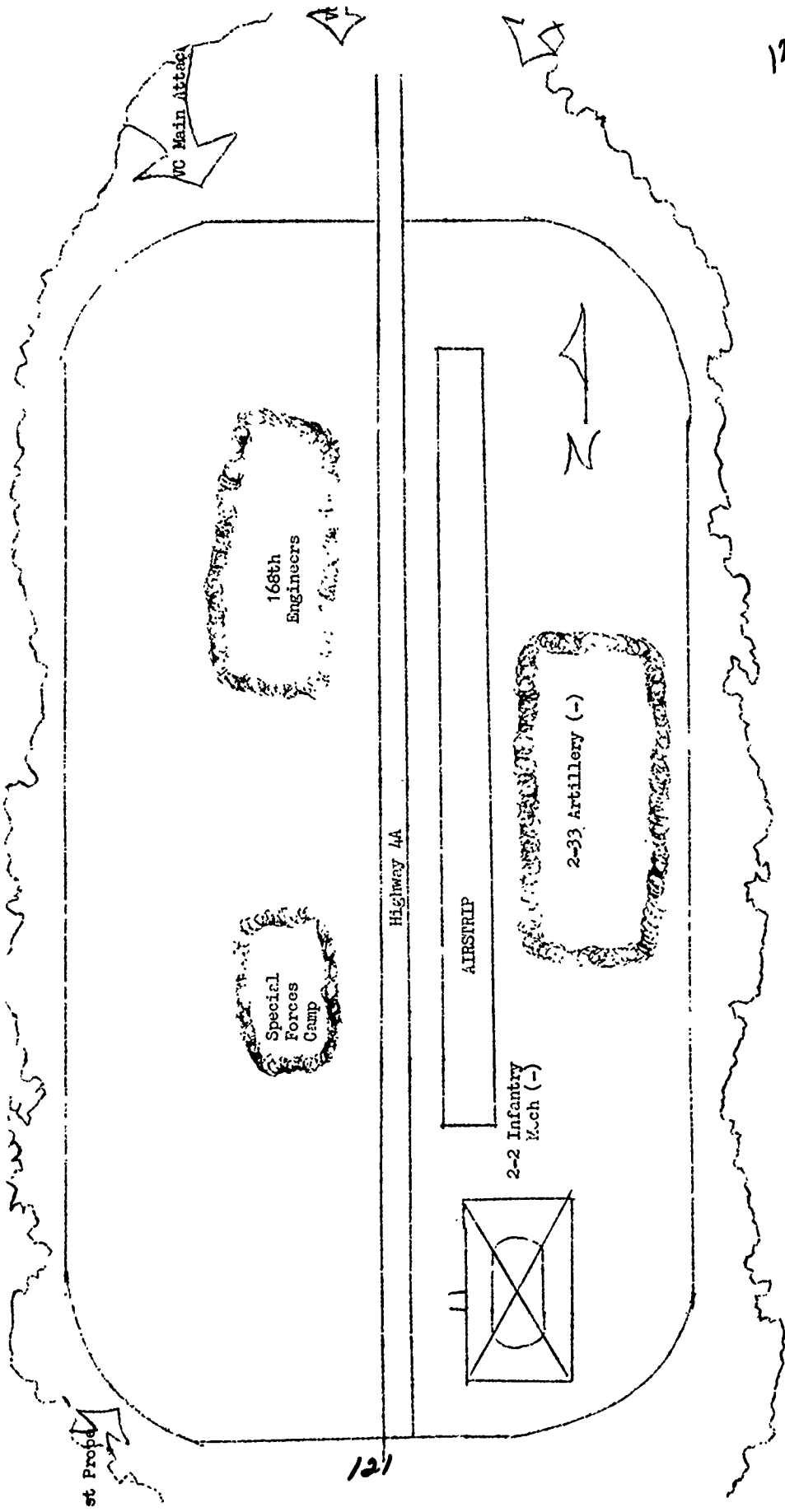

st Prop

NC Main Attac

Highway 4A

AIRSTRIP

2-33 Artillery (-)

2-2 Infantry Kch (-)

168th Engineers

Special Forces Camp

121

3

129

CONFIDENTIAL

DEPARTMENT OF THE ARMY
HEADQUARTERS 1ST INFANTRY DIVISION
17th Military History Detachment
APO San Francisco 96345

AVDB-T

1 August 1967

The Battle of ~~MM~~BO I 14 June 1967

1. The following narrative is an account of the battle that occurred on 14 June 1967 at coordinates XT937669.

A. General:

- (1) Type of action: Meeting engagement and subsequent envelopment by VC.
- (2) 1355H 14 June 1967.
- (3) Friendly unit: B Company, 1-16 Infantry.
- (4) Size of Friendly Unit: 3 platoons and HQ of B Company, 1-16 Infantry consisting of 115 men.
- (5) Estimated NVA/VC force: a VC battalion of the 271st VC Regiment.
- (6) Casualties:

	<u>Friendly</u>		<u>Enemy</u>
KHA	6	KIA	60
WHA	16	POW	0
MIA	0	Equipment Destroyed:	1 five-pound bag of CS.

B. Background:

- (1) At 0905H B/1-16 Inf located and destroyed 1 5-pound bag of CS vicinity XT947665.
- (2) At 1215H A/1-16 Inf engaged 4 VC who fled to the southeast dropping 5 ruck sacks. Artillery was fired into the area vic XT935658. The ruck sacks contained clothing and $\frac{1}{2}$ lb of documents. These captured documents contained eight (8) letters of commendation, all belonging to NGUYEN VAN KHANG, and they indicated that this man is presently the squad leader of the signal company, 272 VC Regiment. The documents also contained training notebooks on radios and weapons. There was included a diagram of a FRC-25 with the name NGUYEN THE QUY. Other documents were an expenditure booklet belonging to NGUYEN NAN CAN, of an unknown battalion. There was a song book which also contained a personal letter and a two (2) page expenditure report of an unknown battalion. The list indicated the expenditures by C1, C2, and C3. This expenditure list also contained letter box numbers indicating unidentified elements of the 271 VC Regt. A notebook classified SECRET contained expenditures of DOAN 24 (OB Holding: AA Bn 5th VC Div).
- (3) The terrain encountered was a variation of thick bamboo to thick triple canopy jungle with trees reaching as high as 200 feet. There was not too much tree deadfall in the area.

DO NOT GRADE AT 3 YEAR INTERVALS
DECLASSIFIED AFTER 12 YEARS
DOD DIR 5200.10

122

CONFIDENTIAL

130

CONFIDENTIAL

(4) Prior intelligence indicated that the 271 VC Regiment was in the area. Bloodhound missions had indicated the presence of a heavy animal scent in the area.

(5) On 14 June 1967 B Company 1-16 Infantry was conducting cloverleaf patrols with the 2d Platoon of B Company leading. The company moved into an area that had been partially cleared 48 hours before by B-52 strikes.

C. The Battle:

(1) At 1355 hours after going 150 to 200 meters on a 270° azimuth the lead squad of the 2d Platoon came out of the thick bamboo to a clearing made by 3 large bomb craters. The lead squad maneuvered around the craters and was approaching the wood line on the far side when VC not visible just inside the wood line in front of the squad opened fire with automatic weapons. The squad dropped into the bomb craters; most of the men went into crater (b) on the diagram. The point was out approximately 25-30 meters ahead of the lead platoon, and the lead platoon immediately moved forward to extend the element and develop the situation. The company forward observer reported the contact and requested artillery which was already firing marching fire for the unit prior to the contact. One of the three point men was killed instantly at (d). The other two point men dropped into crater (a). Some of the left fire team were able to get back into the wood line they had come out of. The right fire team was pinned down in craters (b) and (c).

(2) After about 30 minutes some of the VC had moved to the right flank, and by 1419H heavy automatic fire was coming from the right (N) and front (W). Sniper fire began coming from the left flank. In the meantime the rest of the company had deployed in a perimeter inside the wood line. 1LT Sylvester, 05329952, the 2d Platoon Leader, was in crater (b), and his RTO had been hit. SSG Dmellow, who had been the last man in the left fire team, moved up into crater (b) with his RTO. Artillery fire arrived 3 to 4 minutes after the initial contact in the wood line in front of the craters. After about 15 minutes, the artillery was moved out beyond the VC positions and the first airstrikes came in at 1501 hours, in the area where the artillery fire had been directed. SSG Dmellow noticed that the VC were trying to flank the craters on the right, and he ordered machine gun fire into the wood line, on his right. Immediately after that the enemy on the right stopped temporarily. The men could not move from the craters under the intense enemy fire.

(3) After the first 30 minutes the enemy fire was not so intense. The squad was able to get out of the craters and move back to the wood line behind them, completing the tie-in of the company perimeter. The point men killed at (d) and the two men in crater (a) were thought to be behind the newly formed perimeter on the edge of the wood line. The airstrikes and artillery had an immediate effect on the enemy. The heaviest enemy fire lasted only for the first 30 minutes. During that time the VC moved closer to the men in the craters, but they never assaulted. The VC got within 10-15 meters from crater (b), but they were still in the wood line. The air and artillery was brought in as close as possible, within 20 meters of the US positions. During this time the machine gun fire that had started to come from the right had stopped, after US machine guns fired into the right.

(4) After 30 minutes the company perimeter was formed inside the wood line. Airstrikes and artillery were brought in over the craters to the front. Air and artillery alternated in the same area. Air was not available continuously. Whenever an airstrike came in the artillery was

123
CONFIDENTIAL

121

CONFIDENTIAL

moved farther to the west, behind the VC positions. Then the artillery was moved back in again until the next airstrike. Napalm, 500-pound bombs, and 20mm cannon raked the area. The three men were then spotted to the front. One volley of cannon fire moved from the southwest over crater (a). PFC Biondi, in crater (a) with PFC Gary B. Kipp, called out after the cannon fire hit PFC Kipp in the arm. PFC Biondi also jumped up when a VC grenade landed near him. The grenade explosion resulted in no casualties. It was about one hour after the beginning of the engagement that PFC Biondi called out. VC fire was no longer continuous; however, it was not possible to move around the area of the craters.

(5) At about 1630 hours the enemy fire consisted mostly of sniper fire from a long distance. At this time the 3 missing men were recovered.

(6) During the initial heavy contact, VC near the US perimeter were throwing alot of grenades. Two VC ran through the 3d platoon perimeter throwing grenades. The two VC had automatic rifles. Sgt Patterson, the 3d Platoon Sergeant, chased them and threw grenades at them. CPT ULM, the B Company Commander, killed them near his CP.

(7) At about 1700 hours the company set up another perimeter about 100 meters east of the clearing. The dead and wounded were placed in the center. A few snipers fired into the perimeter in an attempt to locate the US positions. This fire was not returned.

(8) At about 1800 hours C Company, 1-16 Infantry arrived and secured the movement of B Company to another perimeter about 100 meters north. Two medevac helicopters arrived at this perimeter while C Company provided security around B Company. The helicopters drew continuous enemy ground fire. They were both hit heavily but not disabled. One helicopter stayed over the perimeter long enough to lift one casualty on a sling. Deep mud made the operation on the ground difficult, too. It was then decided that B Company would move back to LZ RUFÉ as a company carrying the dead and wounded. C Company secured the movement. By 2242 hours the lead element of C Company reached LZ RUFÉ and by 2330 hours the tail of C Company reached LZ RUFÉ. By 2344 hours the Dust-Offs were completed.

2. Artillery support: A total of 613 rounds of 155mm and approximately 5,022 rounds of 105mm artillery supported the contact from 1355H to 2330H.

3. Airstrikes:

	<u>Request time</u>	<u>TOT</u>	<u>Ordered</u>	<u>Ordnance Delivered</u>	<u>Location</u>
A.	1420	1501	CBU/NAP	500/NAP	XT932688
B.	1500	1500	CBU/NAP	500	XT932668
C.	1515	1535	CBU/NAP	500/NAP	XT932668
D.	1600	1625	CBU/NAP	500/NAP	XT932668
E.	1737	1750	CBU/NAP	500/NAP	XT925665
F.	1845	1900	CBU/NAP	500/NAP	XT940655
G.	1845	1920	CBU/NAP	500/NAP	XT940655

124

CONFIDENTIAL

CONFIDENTIAL

132

4 Helicopter gunship support:

A. CROSSBOW (173d Avn Co): 1 LFT

- (1) Hours: 12
- (2) 2.75mm rockets: 22
- (3) 7.62mm MG: 1,300
- (4) 40mm: 95

(5) The LFT was on standby at CHI LINH (XT9273) to support the 3d Bde operation.

B. REBEL (1st Avn Bn): 2 LFT

- (1) Hours: 19.40
- (2) 2.75mm rockets: 94
- (3) 7.62mm MG: 15,000
- (4) 40mm: 0

(5) One LFT was directed from 1st Brigade at 1600H, the second arrived at 1720H.

C. DARKHORSE (D/1-4 Cav): 2 LFT initially and 1 aircraft with M-5 system released approximately 1830H.

- (1) Hours: 14
- (2) 2.75mm rockets: 42
- (3) 7.62mm MG: 1,200
- (4) 40mm: 0

(5) The LFT arrived CHI LINH at 1635H and was on station from 1710H-1830H making 5 gun passes. At 1830H the gunship with the M-5 gun system (40mm) was released as the aircraft returned to refuel at CHI LINH. The aircraft remained on standby until released at 2025H.

D. DARE O1-G supported the operation with Artillery Observer from 1st Infantry Division Artillery.

- 2 Incl
- 1. Diagram
- 2. Sources

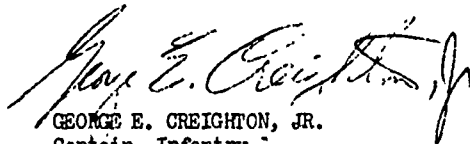
GEORGE E. CREIGHTON, JR.
Captain, Infantry
Commanding

125

CONFIDENTIAL

133

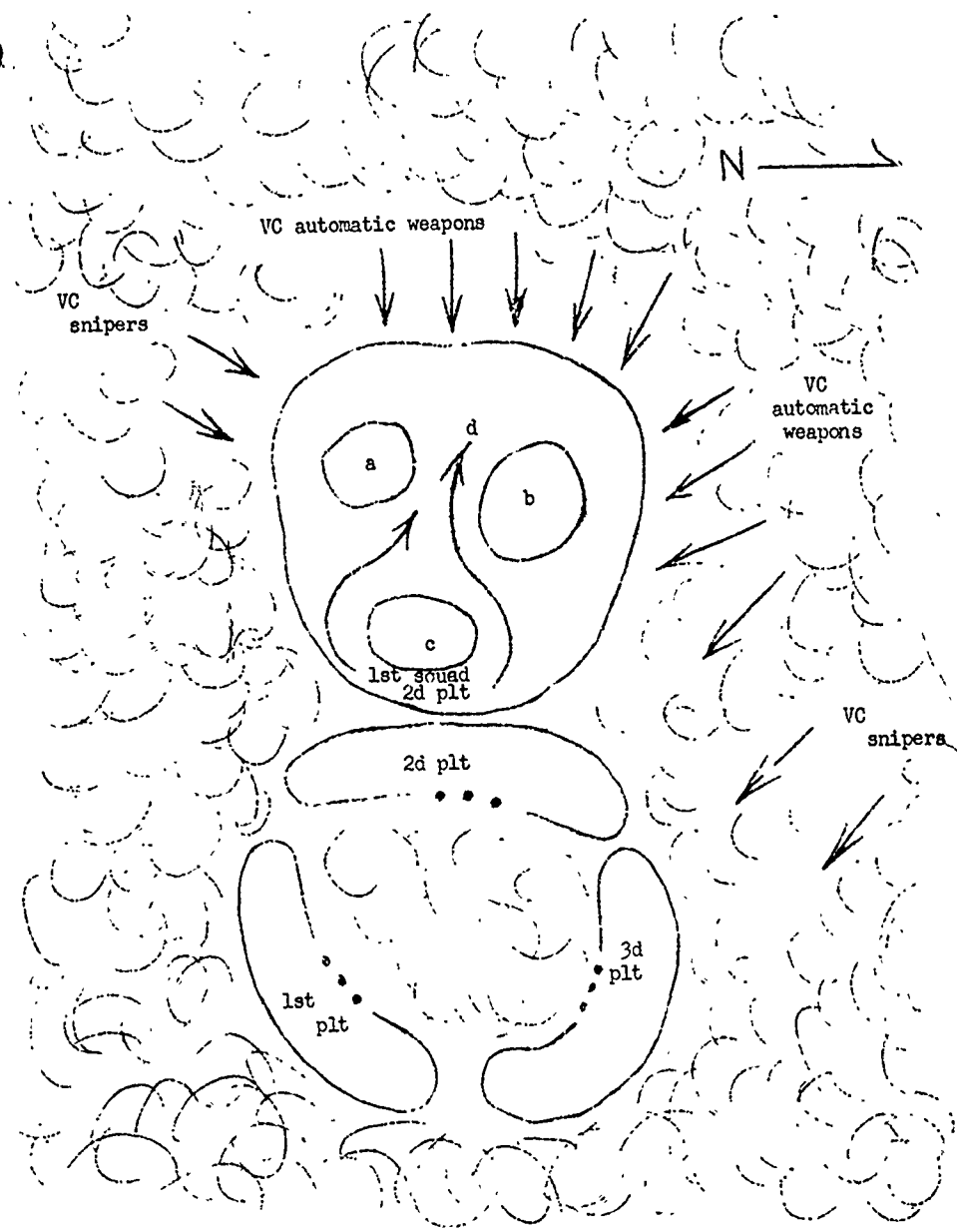

Inclosure 1: Diagram

Battle of KOM BO I

126

134

Inclosure 2: Sources

1. 1st Inf Div G-2 INTSUM.
2. 1st Inf Div G-3 SITREP.
3. G-2 - G-3 journal for 14 June 1967.
4. Interviews of the following personnel conducted by PFC Stephen C. Williams, US51664317, 17th Military History Detachment, at DONG XOAI, RVN, on 20 June 1967:
 - a. LTC Rufus C. Lazzel, 064634, CO, 1-16 Inf.
 - b. CPT Donald S. Ulm, 094449, CO, B Co, 1-16 Inf.
 - c. 1LT Terrance F. Sylvester, 05329952, plt ldr, 2d platoon, B/1-16 Inf.
SSG John D. Dmellow, FA52451614, 2d platoon, B/1-16 Inf.
PFC Thomas A. Biondi, US51977589, 2d platoon, B/1-16 Inf.
5. 1st Inf Div After Action Report - Operation BILLINGS

127

135

CONFIDENTIAL

DEPARTMENT OF THE ARMY
HEADQUARTERS 1ST INFANTRY DIVISION
17th Military History Detachment
APO San Francisco 96345

AVDB-T

1 August 1967

The Battle of XOM BO II (LZ XRAY)
17 June 1967

The Battle of XOM BO was the result of Viet Cong plans to ambush US troops conducting a heliborne assault into landing zone (LZ) XRAY (XT958680). Operating in War Zone D 1st Infantry Division units had found a limited number of clearings suitable for LZ's and night defensive positions (NDP's). The thickness of the jungle surrounding clearings in War Zone D provides a shield from aerial observation to Viet Cong (VC) units waiting in ambush. The enemy found a profitable tactic in predicting the site of a US troop assault and positioning ambush units around it.

The 271st VC Regiment, operating in the TRANG DAL area where the battle took place, knew that US troops were also in the area and that LZ XRAY was a likely location for a heliborne assault. The US troops, however, moved into LZ XRAY by foot. The VC attacked without the advantage they would have had over US troops arriving by helicopter. Nevertheless, the VC conducted a well-planned attack on the NDP which resulted in US losses of 35 killed and 150 wounded. The VC inflicted the heavy losses on the Americans with a series of brief, well-coordinated assaults. By the end of the day, however, the concentrated US fire power had returned the blow and overwhelmed the enemy by inflicting losses which included 222 VC killed.

Background:

On 13 June 1967 the 1st Battalion 16th Infantry (1-16 Inf) conducted a heliborne assault into LZ RUFFE (XT955663) and secured the LZ for the landing of the 2d Battalion 28th Infantry (2-28 Inf). A two-battalion NDP was established, and the units conducted search and destroy patrolling from the LZ in the days that followed. At XT935658 on 141215H June 1967 Company A, 1-16 Inf (A/1-16 Inf) engaged 5 VC who fled but were identified as belonging to the 271st VC Regiment. At 141412H June 1967 B/1-16 Inf in the vicinity of XT937669 engaged what was estimated to be a battalion of the 271st VC Regiment, resulting in 6 US killed, 12 US wounded, and 60 VC killed.

Interrogation of a VC soldier who was captured on 17 June 1967 revealed that on 16 June 1967 four companies of the 271st VC Regiment prepared an ambush site at the battle area around LZ XRAY. No ambush resulted that day, and when the VC returned on 17 June 1967 the US troops were already there, and the fighting began.

On 17 June 1967 the two-battalion NDP at LZ RUFFE was to relocate to LZ XRAY. At 0730 C/1-16 Inf was placed under the operational control (OPCON) of 2-28 Inf to secure the 1-16 Inf portion of the NDP at LZ RUFFE. At the same time B/2-28 Inf was placed under the OPCON of 1-16 Inf to move with elements of 1-16 Inf to LZ XRAY and help to secure the area for the later transfer of the two-battalion NDP from LZ RUFFE to LZ XRAY. The first march unit was, in order of march, A/1-16 Inf, B/1-16 Inf, the reconnaissance platoon of 1-16 Inf (recon 1-16 Inf), and B/2-28 Inf. It departed from LZ RUFFE about 0800 with the mission of moving to LZ XRAY and securing it for the insertion of supplies to be transferred from LZ RUFFE to LZ XRAY by CH-47 aircraft. At LZ XRAY it was planned for the

DOWNGRADED AT 3 YEAR INTERVALS
DECLASSIFIED AFTER 12 YEARS
DOD DIR 5200.10

128

CONFIDENTIAL

CONFIDENTIAL

136

1-16 Inf units to take the eastern portion of the perimeter, from XT958682 to XT962677. A/1-16 Inf would deploy in the north, B/1-16 Inf in the center, and recon 1-16 Inf would secure the C/1-16 Inf sector in the south until C/1-16 Inf arrived. B/2-28 Inf was responsible for the west side of the LZ.

Artillery fire was directed in front of the unit as it marched. The "marching artillery" was discontinued after reaching LZ XRAY. At 1030 A/1-16 Inf arrived at LZ XRAY, and the second march unit, A/2-28 Inf, departed from LZ RUFÉ. To avoid exposing themselves in the clearing, the units began to deploy around it by making their way through the jungle that surrounded LZ XRAY. Approaching the LZ from the south, A/1-16 Inf led the 1-16 Inf units around the east side of the LZ, and B/2-28 Inf moved up the west side.

CH-47 helicopters arrived at LZ RUFÉ about 1100 to extract supplies. At 1115 A/1-16 Inf discovered some freshly dug positions in front of their sector of the perimeter. The holes were only a few inches deep and looked as if they had received one rainfall. At 1125 A/1-16 Inf and B/2-28 Inf linked in the north, completing the securing of LZ XRAY. Movement of supplies from LZ RUFÉ began immediately.

In deploying, B/2-28 Inf spread itself thinly over the west side of the perimeter. There were 15 to 30 meters between individual positions, 30 to 70 meters between platoons, and 50 to 75 meters between the linked positions of B/2-28 Inf and A/1-16 Inf in the north. Contact was to be maintained between the two battalions in the north by patrolling the 50 to 75 meters between the two end positions. A/2-28 Inf, en route to LZ XRAY, was to take over the northwest sector of the perimeter. B/2-28 Inf would then deploy all of its men in the southwestern sector, in positions that were closer together.

CPT William R. Williamson, 094018, the commanding officer (CO) of A/1-16 Inf, deployed his 3d platoon in an overwatch formation in the extreme north, linked with B/2-28 Inf. CPT Williamson tied the 1st platoon in to the right of the 3d platoon; that is, there was the same distance between the two platoons as there was between the positions within the platoon. There were 25 meters between each forward position in A/1-16 Inf. CPT Williamson was in the process of deploying his 2d platoon as a reserve unit behind the 1st and 3d platoons when the engagement started. At the same time B/1-16 Inf had tied in with A/1-16 Inf and deployed in the center sector of the eastern side of LZ XRAY. South of B/1-16 Inf, recon 1-16 Inf divided into nine outposts, called "strong-points", covering the southeast sector from B/1-16 Inf to the end of B/2-28 Inf in the southwest. There were two men at each outpost and 60 to 150 meters between positions. The platoon command post (CP) was set up in the clearing under a few trees, in the southeast near the tree line.

The 1-16 Inf CP was located near some trees in the east-center of the clearing. Elements of the command group of 2-28 Inf set up a forward CP in the clearing nearby. At 1200 B/2-28 Inf returned to the OPCON of 2-28 Inf. At this time the units at LZ XRAY occupied a perimeter made up of positions from 30 to 50 meters into the tree line from the clearing. They were in triple-canopy jungle consisting of tall trees and thick bamboo. The visibility was 15 to 20 meters. Visual contact between US defensive positions was generally non-existent. Immediately on deploying, the units sent out "cloverleaf" patrols. Before the men started digging defensive positions or set up claymore mines in front of the perimeter, the patrols had revealed the enemy's presence, and the engagement was started.

129

CONFIDENTIAL

137

CONFIDENTIAL

The Engagement:

At 1215 CPT Donald W. Sawtelle, 093924, CO A/2-28 Inf, stopped his company after his 2d platoon, the lead element, had entered LZ XRAY, from the southwest. CPT John A. Turner, 094727, CO B/2-28 Inf, discussed deployment instructions with CPT Sawtelle, and CPT Sawtelle then started his company moving north along the B/2-28 Inf positions. B/2-28 Inf's first cloverleaf patrol was re-entering the perimeter, and the second one was starting out. Then, at 1225, one man in the northernmost platoon of B/2-28 Inf, the 3d platoon, spotted 5 walking north. They disappeared before fire could be brought on them. At the same time, 3 VC were spotted climbing into trees in front of another 3d platoon position. Two M-79 rounds were fired at the VC, and the VC ran. The VC were wearing black "pajamas". B/2-28 Inf's second patrol, having reached about 50 meters from the perimeter, was called back in. CPT Sawtelle, figuring that B/2-28 Inf was about to become engaged in the northwest, pulled his company A/2-28 Inf, out of the tree line and began to march them northward in the clearing toward positions where they could provide rear support for B/2-28 Inf.

At 1242 one man in B/1-16 Inf spotted 2 VC east of the perimeter and shot them. A few minutes later he shot two more. At the same time a B/1-16 Inf patrol received two sniper rounds about 100 meters in front of the perimeter. The CO of B/1-16 Inf notified his battalion's CP of the activity, but it was already clear that a heavy engagement was imminent. The intensity of sniper fire was increasing. Patrolling units rejoined the perimeter in the sectors of A/1-16 Inf, B/1-16 Inf, and B/2-28 Inf; recon 1-16 Inf had not sent out patrols from its sector. At about 1245 a CH-47 resupply helicopter received several small arms rounds over the LZ and returned to LZ RUFFE, where it landed in a disabled condition. At 1255 B/2-28 Inf and A/1-16 Inf were receiving heavy automatic weapons and small arms fire from the north. The 2d platoon of A/2-28 Inf (2/A/2-28 Inf) was immediately pinned down in the clearing behind 3/B/2-28 Inf. The heaviest enemy fire was brought on the two northernmost platoons, 2/B/2-28 Inf in the northwest and 3/A/1-16 Inf in the northeast.

Artillery and light fire team gunship helicopters were requested, and response was immediate. Tactical air support was requested at 1252. With 105mm Howitzers of the 2-33 Artillery providing principal support, the artillery fire arrived about 1300. The first rounds were directed to fall about 200 meters north of the perimeter, and the artillery gained effectiveness as it was adjusted closer. Two gunships arrived and began providing continuous support to the units in the north.

At 1306 at least three groups of VC began simultaneous ground assaults on the left flank of 3/A/1-16 Inf and the end position on the right flank of 3/B/2-28 Inf. The US troops used ant hills and clusters of bamboo for cover. Sixty or seventy VC in two orderly groups moved toward 3/A/1-16 Inf throwing hand grenades and firing automatic weapons. RPG's and anti-tank weapons were also used against the US positions. The VC concentrated on the left flank of the 3d platoon. The M-60 machine gun position there was knocked-out immediately when an RPG round hit the position, wounding the men and leaving the gun inoperative. The VC killed or wounded all of the left flank of the 3d platoon of A/1-16 Inf. It was reported by troops in the action that the VC used a chemical agent, probably a type of tear gas, on the 3d platoon positions. The right flank of the platoon was able to move back and join the 2d platoon line about 40 meters to their rear. The dead and the wounded who were unable to move had to be left forward. The new line formed by the 2d platoon and men from the 3d platoon was about 15 meters from the clearing, and directly behind the original 3d platoon positions. At the beginning

130

CONFIDENTIAL

130

CONFIDENTIAL

of the engagement of A/1-16 Inf, support from the company's two 81mm mortars was requested in addition to the artillery fire. Both arrived immediately, but the company mortars could place close-in fire on the enemy during the time the artillery was being adjusted into the area near the perimeter, where it would be most effective. After about 10 minutes, effective artillery was falling, two gunships were firing into the area, and heavy US automatic fire was delivered from the newly-formed line with the 2d and 3d platoons. The attacking VC had reached the original 3d platoon positions then ended their first assault. This was at about 1315.

In the meantime, a group of VC attacking B/2-28 Inf had killed the two men in the northernmost position of that company at the start of the assault from the north. Two VC occupied the position and started firing from it, using the US bodies as a shield. Other small groups of VC approached the northern positions of B/2-28 Inf, wounding several of the men on the platoon's right flank. The platoon sergeant, SFC Billie J. Dodd, RA16526378, took four of his men toward the end position that had been taken by the VC. The VC fired on the group, killing two and wounding SFC Dodd. PFC Ben Walker, US56824413, the radio operator Dodd had chosen to help retake the lost position, was unwounded and moved to his right, where he found some cover from enemy fire. He stayed in this spot, about 30 meters from the VC and isolated from US positions, until the VC finally withdrew. He used his radio to report on the battle and direct artillery. The other unwounded man, PFC John J. Rieck, Jr., US51825322, gave first aid to SFC Dodd and returned to the platoon CP to get a medic. Another member of the 3d platoon, SP4 Dannie Smith, US52631525, occupied the position next to the end one that had been overrun and held his position alone through most of the engagement. He could not see the US positions on either side of his. Three VC approached his position from 50 to 75 meters away. They wore black "pajamas" and had among them one AK-47 and two carbines. Smith moved behind a small tree and stayed there throwing grenades and firing his M-16 at the three VC, who fired and threw grenades at Smith from behind an ant hill. Smith left his position when an enemy round hit one of his smoke grenades, which made his clothes start to burn. Smith ran back to the clearing where men of A/2-28 Inf put out the fire and gave first aid to his burns.

At about 1325 a 60mm mortar barrage was directed against the northern elements of A/1-16 Inf and B/2-28 Inf. The barrage consisted of 15 to 20 rounds and ended at 1330. The rounds were most effectively placed around the left flank of A/1-16 Inf and accounted for the majority of that company's wounded. The assault at 1306 had been responsible for most of the company's killed. The enemy attack in the north was coordinated so that as soon as the mortar rounds stopped falling, at 1330, the VC were in front of the 2d-3d platoon line of A/1-16 Inf and began a second large ground assault. It was coordinated with increased pressure on the B/2-28 Inf right flank as well as a simultaneous assault on recon 1-16 Inf in the southeast.

The 1330 assault on A/1-16 Inf consisted of apparently the same groups of VC attacking the same area that had been hit in the first assault. This time, however, A/1-16 Inf had a stronger left flank, with the 2d and 3d platoons' lines consolidated, and artillery was already falling close in front of the US positions. During the second VC assault from the north, fifteen minutes of continuous artillery fire fell in front of A/1-16 Inf. Though the enemy was next to the perimeter before the ground attack even started, they could not again overwhelm the US with their heavy automatic weapons and RPG fire. The VC got within 30 meters of the tree line, or 15 meters from the 2d-3d platoon line. A rifleman in the 3d platoon, PFC Daniel J. Phelps, RA16929631,

131

4

CONFIDENTIAL

131

CONFIDENTIAL

saw a group of 10 VC assaulting his two-man position. The VC wore black "pajamas" and were walking and firing at the same time. They got within 25 meters of Phelps' position, which was behind an ant hill. With about 2 minutes of automatic M-16 fire Phelps and his partner killed the 10 assaulting VC. Then the other rifleman with Phelps was hit and killed, probably by a sniper. Phelps stayed at this position through the entire engagement. He could see no other US position from his. Phelps saw and shot VC crawling toward his position one at a time. He saw VC bodies being dragged away, but the bodies of the 10 VC who assaulted remained in front of Phelps' position. The A/1-16 Inf CP had been moved from the center of the company's sector to the area that was being assaulted so that the CO could have better control of the action, and the forward observer could adjust the artillery close to the area that was being attacked. Soon after 1330 the radio operator of A/1-16 Inf reported that he and the company commander were wounded and that he could see two VC entering the perimeter. These were apparently the only VC that broke through the A/1-16 Inf perimeter on the second assault, and they were killed immediately. With a medic attending his wounds, CPT Williamson continued to command his company throughout the battle. The US artillery barrage was so close to the perimeter that occasional pieces of shrapnel reached the friendly positions through the trees. Still hot after filtering through the umbrella of bamboo, the shrapnel sizzled on the men's wet clothes. It was largely a result of this massive, close-in artillery support that the VC were unable to reach the US positions as they had in the first assault on A/1-16 Inf. The VC withdrew suddenly at 1345.

At the same time as the second assault on A/1-16 Inf started, at 1330, the VC moved in on the right flank of B/2-28 Inf, which was next to A/1-16 Inf in the north. Artillery fire was then heavy and effectively holding back the VC. The artillery fell within 30 meters of the perimeter. The 2d platoon of A/2-28 Inf, pinned down in the clearing behind B/2-28 Inf's right flank, crawled south toward some trees near the center of the LZ. Because of heavy automatic weapons fire they were unable to stand up in the tall elephant grass in order to open fire. At about 1335 they formed an east-west line across the clearing sealing off the two battalions' CP's from the north. They then stood up and fired into the tree line, aiming high to avoid hitting US positions whose locations were unknown. The 2-28 Inf's caliber .50 machine gun was set up there and was used effectively against snipers in trees.

It appeared to the men of B/2-28 Inf that the VC could not see their line, as the VC fired at smoke grenades whenever they were thrown. Otherwise the VC did not fire unless they saw a US troop move. It was reported by men of A/2-28 Inf that tear gas was in the air in the northern portion of the LZ on two separate occasions during the battle.

Apparently coordinated with the attack on the US positions in the north, at 1330 a large group of VC assaulted recon 1-16 Inf in the south-east. The VC assault covered a 40-meter front. Two outposts were engaged by the assault group, but the fire was concentrated on an M-60 machine gun position and the platoon CP. The CP was located in the clearing directly behind the M-60 position. The machine gun position was immediately overrun. The US positions were too far apart to prevent the VC from penetrating the perimeter at that point. The positions on the platoon's right flank were receiving sniper fire. Three VC were observed south of the perimeter and were engaged, with unknown results. At the platoon CP the artillery observer had just finished making initial adjustments on supporting fire for in front of the perimeter when his radio operator was hit and the radio destroyed. The CP was receiving heavy automatic weapons fire, and it was decided that the CP group could not hold the position. The wounded had to be evacuated first, so the

132

CONFIDENTIAL

CONFIDENTIAL

140

platoon sergeant, SSG Gracie E. Sanders, RA14723897, the artillery observer, and a medic left, carrying three wounded men. Before he left, SSG Sanders saw 8 to 10 VC approaching the CP. The VC wore khaki uniforms, steel helmets, bandoleers, and web gear. The wounded were carried to a point on the left flank of the platoon, near the B/1-16 Inf positions. The platoon leader, talking by radio to the CO of 1-16 Inf, reported that his CP group had killed more than 30 VC, saying they were "stacking them up like cordwood." Radio contact with the recon platoon CP was then lost. The VC killed all of the group at the CP and frisked their clothes. The CO of 1-16 Inf ordered an element of the battalion headquarters company to move toward the recon platoon's sector to provide assistance. At 1341 the first airstrike arrived, about 150 meters east of the perimeter. The VC withdrew at about 1345, using the same break in the line through which they had entered.

Continuous air support was provided east and southeast of LZ XRAY. The fire coordination line ran north and south through the NDP. Artillery was the principal deterrent placed on the enemy assaults on A/1-16 Inf and B/2-28 Inf in the north and northwest; airstrikes provided the most effective support for recon 1-16 Inf in the southeast. Part of one airstrike, however, was delivered on the west side of the LZ, killing 2 men in B/2-28 Inf.

Although the enemy assault groups all withdrew from around LZ XRAY at about 1345, the US positions continued to receive heavy automatic weapons fire. By 1350 a platoon of A/2-28 Inf had formed a line of blocking positions across the clearing just above the recon 1-16 Inf sector. At 1355 two gunships were called to provide additional support in front of the recon platoon sector. At 1403 the elements of 1-16 Inf and 2-28 Inf located at LZ RUFEE received 10 60mm mortar rounds and small arms fire lasting for about one-half hour.

Around LZ XRAY the sources of the enemy automatic weapons fire were moving farther from the US positions. All units at LZ XRAY started their efforts to collect the wounded and move them to the evacuation point in the center of the NDP. By 1445 most of the VC automatic weapons fire had stopped. Sniper fire from a distance continued until about 1500, when all incoming rounds stopped. By 1500 recon 1-16 Inf had moved all its men, casualties, and equipment within the perimeter formed by the A/2-28 Inf blocking positions. Helicopter evacuation of casualties from LZ XRAY began after 1500 and lasted until about 1850.

At about 1530 a barrage of 30 to 35 60mm mortar rounds was concentrated on the B/2-28 Inf CP area in the west and the area newly occupied by recon 1-16 Inf in the south.

After US casualties and equipment had been removed from the recon 1-16 Inf sector, there was no other police mission conducted in that area until the following day. The search of the battlefield in the north covered a maximum of 100 meters from the US positions. Recovering US casualties and equipment, A/1-16 Inf found 35 to 40 VC bodies in front of their positions. Most of the VC bodies wore khaki uniforms, looked well fed, and had new Soviet assault rifles. A/2-28 Inf also conducted a limited search of the area in front of the northern sector of the perimeter. They found 2 VC bodies and shallow depressions in the ground that looked as if they had been dug under fire. A large amount of communication wire ran on trails between most of the enemy positions.

Initial interrogation of a captured enemy soldier was very limited because the prisoner was wounded and had to be evacuated. In subsequent interrogation the prisoner stated that he was one of a group of 30 to 50

133

6

CONFIDENTIAL

144

CONFIDENTIAL

North Vietnamese infiltrators who had recently been assigned to the 2d Battalion of the 271st VC Regiment. His unit moved to the battle area on 7 June 1967. On 16 June the 1st and 2d Battalions of the 271st VC Regiment had prepared the ambush site at LZ XRAY because they knew that US troops had entered the area on 13 June. Each company had three 60mm mortars and a Chinese heavy machine gun of unknown type. The VC had spent the night of 16 June at another location and returned to LZ XRAY on 17 June after the US troops had arrived.

At 1610 1-16 Inf was notified that the 1-18 Inf would replace Company A, the headquarters company, and the recon platoon of 1-16 Inf at LZ XRAY. 1-18 Inf began arriving at LZ XRAY by helicopter at 1627. The helilift was stopped at 1700 when LZ XRAY received a 50 to 60-round barrage from 60mm and 81mm mortars. After 1710 there was no further enemy activity. Counter-mortar fires were employed, and the lift of 1-18 Inf was subsequently completed. The lift of A/1-16 Inf and recon 1-16 Inf to CHI LINH was completed at 1830. The lift of the headquarters company of 1-16 Inf to LZ RUFE was completed at 1855.

The last airstrike was delivered at 1915. There was a total of 43 tactical air sorties in support of the action at LZ XRAY. Ordnance requested was CBU and napalm. Ordnance delivered was CBU, napalm, rockets, 500-pound and 750-pound bombs, and 20mm cannon fire. A total of 8,250 artillery rounds were fired in support of the battle. There were 7,621 rounds of 105mm, 513 rounds of 155mm, 38 rounds of 175mm, and 78 rounds of 8 inch artillery.

On 18 June 1967, 1-18 Inf conducted a search of the battle area. They found 26 bodies, which brought the body count of enemy killed to 222. It is likely that the VC removed a large number of their dead.

George E. Creighton, Jr.
GEORGE E. CREIGHTON, JR.

- 4 Incl
- 1. Diagram of 1306 assault
- 2. Diagram of 1330 assault
- 3. Sources
- 4. ~~Map Sheet 6331 I N~~ ~~with~~ ~~drawn~~ ~~has~~ ~~DA~~
(Series 18030) Has DA

Captain, Infantry
Commanding

134

CONFIDENTIAL

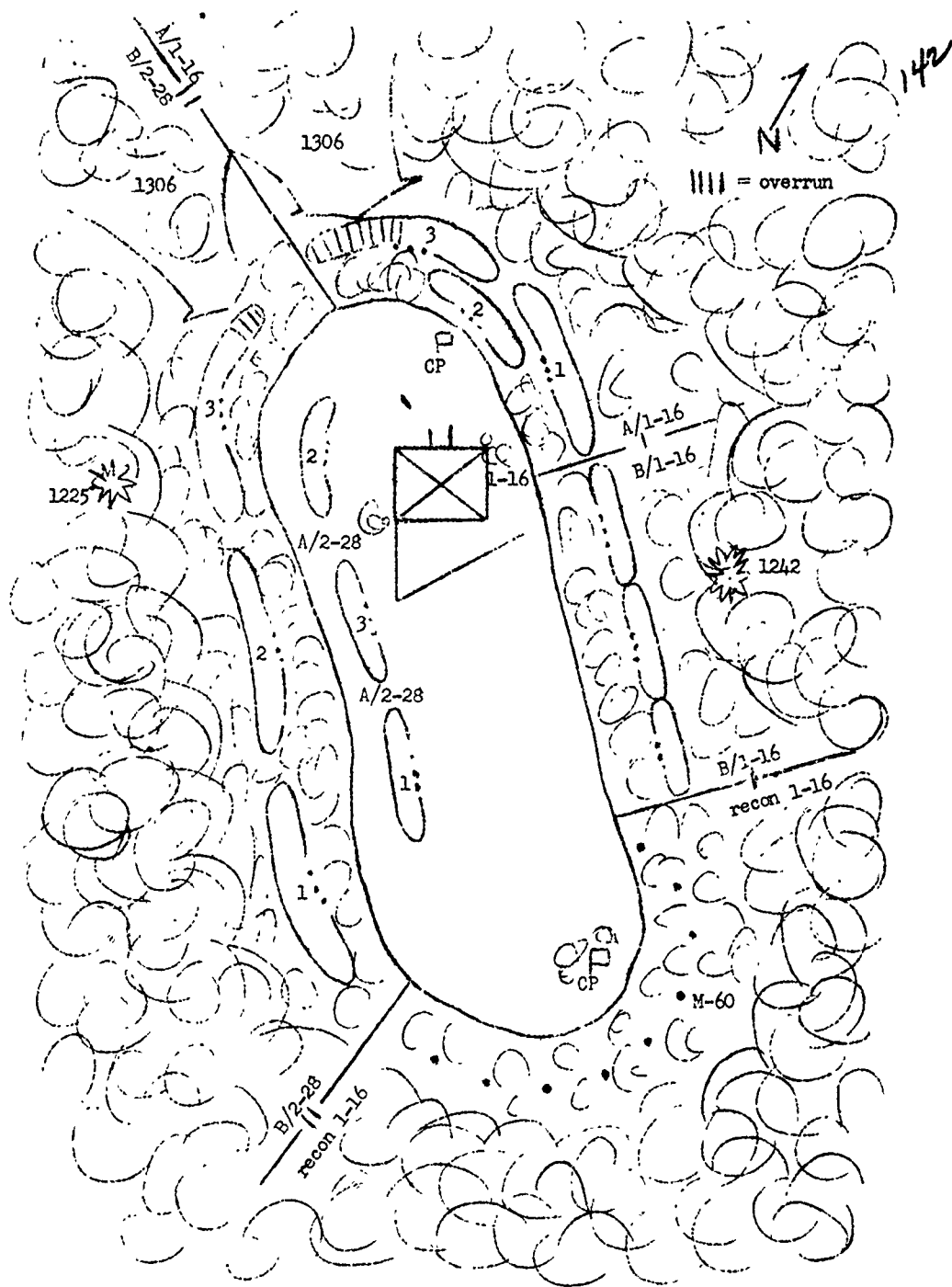

Inclosure 1: Diagram of 1306 assault

Battle of XOM BO II

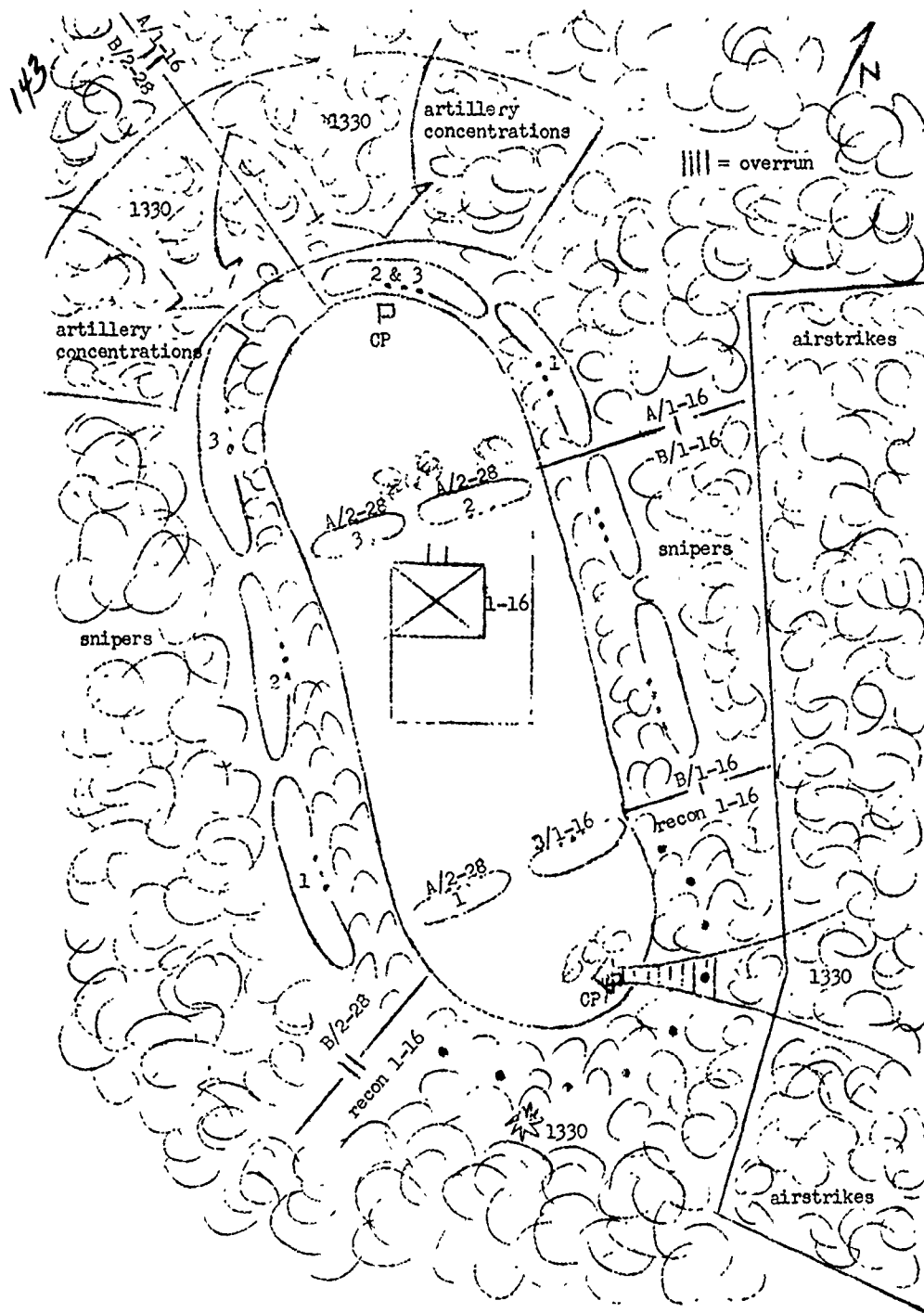

Inclosure 2: Diagram of 1330 assault
 Battle of XOM BO II

144

Inclosure 3: Sources

1. 1st Inf Div G-2 INTSUM.
2. 1st Inf Div G-3 SITREP.
3. 1-16 Inf journal for 17 June 1967.
4. 1-16 Inf report on 17 June 1967 engagement.
5. 2-28 Inf journal for 17 June 1967.
6. 2-28 Inf report on 17 June 1967 engagement.
7. Interviews of the following personnel conducted by PFC Gary C. Meade, RA16879290, 17th Military History Detachment, on 22 and 23 June 1967 at DONG XOAI, RVN:
 - a. LTC Rufus C. Lazzel, 064634, CO, 1-16 Inf.
 - b. SSG Gradie E. Sanders, RA14723897, plt sgt, recon 1-16 Inf.
 - c. SFC Earnest H. Clutts, RA14502772, plt sgt, 3/A/1-16 Inf.
8. Interviews of the following personnel conducted by PFC Stephen C. Williams, US51664317, 17th Military History Detachment, at or near LAI KHE, RVN, on the dates indicated:
 - a. 20 June 67: CPT Donald S. Ulm, 094149, CO, B/1-16 Inf.
 - b. 27 June 67: CPT John A. Turner, 094727, CO, B/2-28 Inf.
 - c. 27 June 67: SSG James Jimenez, RA19825290, 3/E/2-28 Inf.
SP4 Joseph L. Hare, US52647537, 3/B/2-28 Inf.
SP4 Frank C. Holzworth, US52672590, 3/B/2-28 Inf.
PFC Gary W. Wisdom, US56581012, 3/B/2-28 Inf.
PFC Ben Walker, US56824413, 3/B/2-28 Inf.
 - d. 27 June 67: SP4 Dannie Smith, US52631525, 3/B/2-28 Inf.
 - e. 28 June 67: CPT Donald W. Sawtelle, 093924, CO, A/2-28 Inf.
 - f. 28 June 67: 2LT Patrick M. Jones, 05332026, plt ldr, 2/A/2-28 Inf.
 - g. 4 July 67: CPT William R. Williamson, 094018, CO, A/1-16 Inf.
 - h. 4 July 67: SSG Gradie E. Sanders, RA14723897, plt sgt, recon 1-16 Inf.
SGT Mose J. Howa, US56393200, recon 1-16 Inf.
 - i. 4 July 67: PFC Daniel J. Phelps, RA16929631, 3/A/1-16 Inf.
9. 1st Inf Div After Action Report - Operation BILLINGS.

137

145
CONFIDENTIAL

DEPARTMENT OF THE ARMY
HEADQUARTERS 1ST INFANTRY DIVISION
17th Military History Detachment
APO San Francisco 96345

AVDB-T

31 July 1967

Small Unit Action
C Company, 1-2 Infantry
at XT675868 on 21 March 1967

Prior to the 21 March 1967 action described in this narrative, the Viet Cong conducted numerous attacks along or in the vicinity of Route 246. On 17 March 1967 the 1st Battalion, 2d Infantry with A Troop, 3d Squadron, 5th Cavalry (-) and B Company, 2d Battalion, 47th Infantry received one round of sniper fire near the road with no resulting casualties. On the same day A/3-5 Cavalry received sniper fire resulting in 3 US WHA. At 191230H March 1967 an M-113 Armored Personnel Carrier (APC) of A/1-4 Cavalry working that day with the 1-2 Infantry was hit by an RPG round resulting in 2 US WHA, and slight damage to the vehicle. Small arms fire was also received that resulted in no casualties. Also that day at 1345 hours another M-113 hit a mine resulting in extensive damage to the track and no US casualties. At 210725H March 1967 an engineer 5 ton truck hit a mine on Route 246 that resulted in 1 US WHA and the truck was totally destroyed.

The 1-2 Infantry under the command of LTC William C. Simpson, 028381, was established along Route 246 to conduct a series of patrols each day in order to secure the road and the west bank of a bridge construction site at XT623816. At 210830H March 1967 C Company, 1-2 Infantry under the command of CPT Gilbert Wichert, 092270, Bellevue, Nebraska mounted M-113's and moved up Route 246 to a checkpoint (CP), Number 9, which was secured by engineers.

Intelligence furnished CPT Wichert indicated that the enemy in the operational area was normally local guerrillas, but one could expect to meet main force units that would travel through the area. Experience gained from operating in the area during the past several days indicated that the guerrillas were relying on hit and run tactics. The feeling of the intelligence community was that large enemy troop units were probably moving through the area so the decision was made by LTC Simpson to conduct company size patrols.

At 0915 hours the company size patrol of 72 men departed CP #9 and moved on a 340° azimuth. The company was organized into three rifle platoons, minus the weapons platoon. Each rifle squad averaged 3 to 4 men. Every few minutes the company would stop, break down to smaller subordinate units, and conduct "cloverleaf" patrolling--a form of saturation patrolling in the 1st Infantry Division.

As the patrol moved through the jungle the order of march was 1st Platoon, 2d Platoon, Headquarters group, and 3d Platoon.

The artillery forward observer (FO), 1LT John Bowman, 055020236, Bayonne, New Jersey placed artillery fire to the front and flanks while the company formed a perimeter for "cloverleafing" or while the company was marching through the jungle. The FO had one 105mm howitzer from D Battery, 1-5 Artillery in direct support of the patrol.

DOWNGRADED AT 3 YEAR INTERVALS
DECLASSIFIED AFTER 12 YEARS
DOD DIR 5200.10

131
CONFIDENTIAL

CONFIDENTIAL

146

At about 1000 hours the company halted and formed a company size base with the command group in the center. The 1st Platoon crossed a stream and established the western portion of the perimeter. The 2d Platoon established the eastern side of the patrol base. The 3d Platoon remained outside of the patrol base and prepared to go on patrol. Two observation posts per platoon were established at a distance of 5 to 75 meters from the perimeter. Small cloverleaf patrols were conducted in the immediate vicinity of the patrol base. The company commander (CO), CPT Wichert, briefed SFC Tyson M. Hall, RA38882227, New Boston, Texas, who was the 3d Platoon leader and whose platoon was preparing to go on patrol.

The company patrol base was established next to the junction of three streams as the area appeared to CPT Wichert to be a logical VC base camp area. A small destroyed village was located about 800 meters from the patrol base. One could find other villages and ruins at a distance of about 2,000 meters. The jungle in the area was dense and not frequented by artillery destruction fires.

At 1100 hours SFC Hall returned to his platoon and briefed his squad leaders on the mission they were to accomplish. After they had received the mission they collectively discussed the concept of the operation, specific actions to be taken upon contact, the location of the machine guns in the column so that they would be readily available when needed, and danger points along their route of march. One should note that all of these men agreed that their major danger point would be the streams along the march route.

At 1115 hours SFC Hall moved his platoon out on patrol and moved for 500 meters, paralleling the east bank of the stream. They moved with two squad files abreast and the point squad to the front. Once they completed their first leg of the patrol they moved on a new azimuth perpendicular to the stream.

While searching the jungle areas around them the 3d Platoon encountered no VC. At a distance of 25 meters from their first checkpoint a trail was found which appeared to be frequently used. SGT Harry W. Warlick, RA137-69598, Baltimore, Maryland had noticed a small fence of interwoven bamboo branches along their route of march before arriving at the trail. Normally VC base camps found in the 1st Division area have a fence similar to the one found by SGT Warlick. It is believed that the Viet Cong use these fences to trap and pen animals, and for the control of fire and movement.

SFC Hall continued to move his patrol toward the stream. As they moved he continued to maintain radio contact with the company commander who was monitoring the patrol's progress.

With the 1st Squad at the point and the 3d Squad at the right flank, both squads silently reached the winding stream bank at the same time.

Tall grass and jungle shrubs were prevalent in the area around the stream. As it was the dry season the stream bed was shallow and easy to cross.

Upon reaching the stream with the intent of reconnoitering and crossing, PFC Gordon A. Shaw, US56435705, looked across the stream and saw some clothing hanging from a tree. He looked up the creek and saw 2 VC standing on the opposite bank. Then he signaled for his squad.

SP4 Carl E. Holcomb, US56433705, Modena, Illinois, 1st Squad Leader, moved up toward Shaw's position and observed the 2 VC washing their canteen cups in the stream. It appeared to the 2 US soldiers that the VC had finished eating. Two more VC were observed in a base camp 15 to 20 meters away. SP4 Holcomb then requested that the M-60 machine gun be brought forward.

137

2

CONFIDENTIAL

147

CONFIDENTIAL

SFC Hall said, "When the point spotted the pajamas hanging up on a wash line and the 3d Squad on my right flank reported they saw a fortified base camp, I immediately had the machine gun crew behind me move up to assist SGT Warlick."

When the machine gun crew reached SGT Warlick he personally took the machine gun and placed it into its firing position.

As the reports of the observed VC reached CPT Wichert, he immediately requested a fire mission from the artillery. The artillery concentrations were to be initially placed 600 meters to the north of the VC base camp as blocking fires. He also requested an aerial observer (AO) and learned that LTC Thomas R. Dennis, 01686815, CO, 1st Battalion, 5th Artillery was in the air and would act as the AO. CPT Wichert then ordered his reconnaissance squad, which was patrolling a different area, to return to the company patrol base to join the rest of the company and prepare to assist the 3d Platoon. Once the company was assembled they began to move toward the 3d Platoon. The order of march was the 2d Platoon, the command group, and the 1st Platoon at the rear of the column.

Meanwhile the 3d Platoon silently moved into their attack positions. They could see the VC moving around unaware of the pending assault. The VC that could be seen were wearing black uniforms with shoulder epaulets and buttons. The men stated that the camp had a fishy odor which is peculiar to most VC base camps that they had visited. As the nine men moved into position with SGT Warlick they could see 5 VC moving toward the stream and 2 VC were standing on the river bank. A total of 7 VC were in their view.

At 1243 hours the 3d Platoon, C Company, 1-2 Infantry commenced its attack on the Viet Cong. Just prior to the attack the VC at the river bank heard or sensed the danger because they all turned around simultaneously and headed quickly toward their bunkers. It was at this time that the 3d Platoon opened fire on the VC for about 20 seconds with a large volume of small arms and automatic weapons fire. During the initial burst of fire the VC fired back; this was the only time the US troops received hostile fire. While SGT Warlick's men fired the sergeant was informed by CPT Wichert that the balance of the company was moving up to assist and reinforce. SGT Warlick then threw out several yellow smoke grenades to mark his troops' positions for the aerial observer.

Troops taking part in the action immediately saw the enemy's reaction. SP4 Isreal Armandores, Merced, California, said, "As soon as they tried to take off I opened fire with my machine gun." PFC Dean Harris, US558-45564, Berice, Indiana, said, "There were bullets flying all over the place. The first burst of fire dropped the 5 VC at the stream at once."

As soon as the artillery forward observer, 1LT John Bowman, heard the gun fire he requested an aerial observer and direct support of a full battery of artillery rather than just the one tube that had been supporting the company. The aerial observer was needed to adjust the artillery fire and to relay the fire commands. 1LT Bowman said, "As we moved to join the platoon in contact, the aerial observer had complete control of the fire missions. Once we joined the platoon on the stream I brought the artillery in closer to the VC, within 200 to 300 meters of our positions. We continued to fire artillery in the general area for 3 to 3½ hours. Also, airstrikes were later put in to our north. During the airstrikes I shifted the artillery fire to our west so we would have a constant volume of artillery blocking fires."

140

CONFIDENTIAL

CONFIDENTIAL

148

CPT Wichert said, "The airstrikes dropped 500-lb high fragmentation bombs, UBU, and napalm. While the 3d Platoon laid down a steady base of fire on the VC base camp, I maneuvered the 2d Platoon around and had them line up into an infantry assault line. I took ten minutes to prepare the assault in order to make sure each man knew his job and had a sector of fire. My men opened fire on their assigned sectors, and, at my command, the 2d Platoon began a frontal assault on the VC base camp. The 1st Platoon remained in reserve to secure the rear area." The men of the 2d Platoon ran into the ankle deep water at the foot of the river bed and fired their rifles and threw hand grenades as they attacked the VC base camp." CPT Wichert said, "Using marching fire, the 2d Platoon moved on line across the stream and entered the VC base camp. The sound of the initial exploding hand grenades, plus verbal instructions, signaled the 3d Platoon to lift their supporting fires prior to the assault."

The men assaulted into the VC base camp. PFC Donovan K. Nash, US558-50766, St. Louis Park, Minnesota, an assistant machine gunner commented, "We moved up, laying down a base of fire as we moved, and we killed two more VC as we overran their positions."

To PFC Jack L. Robinson, US55334313, Bonham, Texas, "Everything went like clockwork. We moved up with no opposition; everyone did his job well."

As the troops swept through the VC camp CPT Wichert noticed a bandaged VC attempting to escape. CPT Wichert said, "There was one VC survivor who was wounded and bandaged around the chest. I saw his movement and shot him. Then after the sweep was over I organized the company into a perimeter that included the captured VC base camp. Observation posts were established and a series of cloverleaf patrols were conducted 100 to 150 meters out from the perimeter."

After taking the VC base camp CPT Wichert had his executive officer, 1LT David E. Douglas, O5326393, supervise the search of the area and the bodies. The lieutenant used the company reconnaissance squad, called the "Leopards", for the detail. The Leopards were established by CPT Wichert to give his company a long range reconnaissance capability. CPT Wichert gave the following account of the Leopards. "The Leopards were volunteers who had combat experience. They were distinctive than the other men in the unit in that they were permitted to wear camouflage uniforms. Working with the Leopards was a brave little Vietnamese National Policeman nicknamed the Gook. To the Leopards, the Gook was a brave and highly respected soldier. He spoke Vietnamese, Czechoslovakian, and French; he did not speak English. Even though he did not speak English he still acted as an interpreter."

A search of the area failed to turn up more VC. It is probable that there were more VC in the area during and prior to the action as there were 12 rucksacks found but only 8 VC KIA.

CPT Wichert concluded, "At 1530 hours we returned to the battalion base camp. That night the dead 'Charlies' bought beer for the company with the money found on their person."

This action resulted in no US casualties and 8 VC KIA by body count.

Captured enemy equipment included the following: 5 CHICOM rifles, 2 US carbines, 1 P-38 pistol, 2 bayonets, 1 2-lb block of TNT, documents, 1 RPG-2 launcher with 13 rounds, 12 60mm mortar rounds, 200 rounds of small arms ammo, 2 AK-47 magazines, 200 feet of double strand wire, 1 CHICOM claymore, 5 fragmentation grenades, and 1 CHICOM compass.

141
CONFIDENTIAL

149

CONFIDENTIAL

The enemy documents indicated new letter box numbers from the HON QUANG District unit file that became effective on 1 February 1967 for BINH LONG Province. These documents confirmed letter box numbers found by earlier patrols such as the 1-18 Inf who found a duplicate list. Also a sketch map of what appeared to be the AN LOC Plantation was among the documents.

1 Incl
Diagram

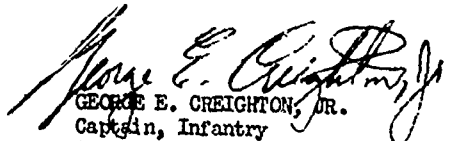
GEORGE E. CREIGHTON, JR.
Captain, Infantry
Commanding

142

CONFIDENTIAL

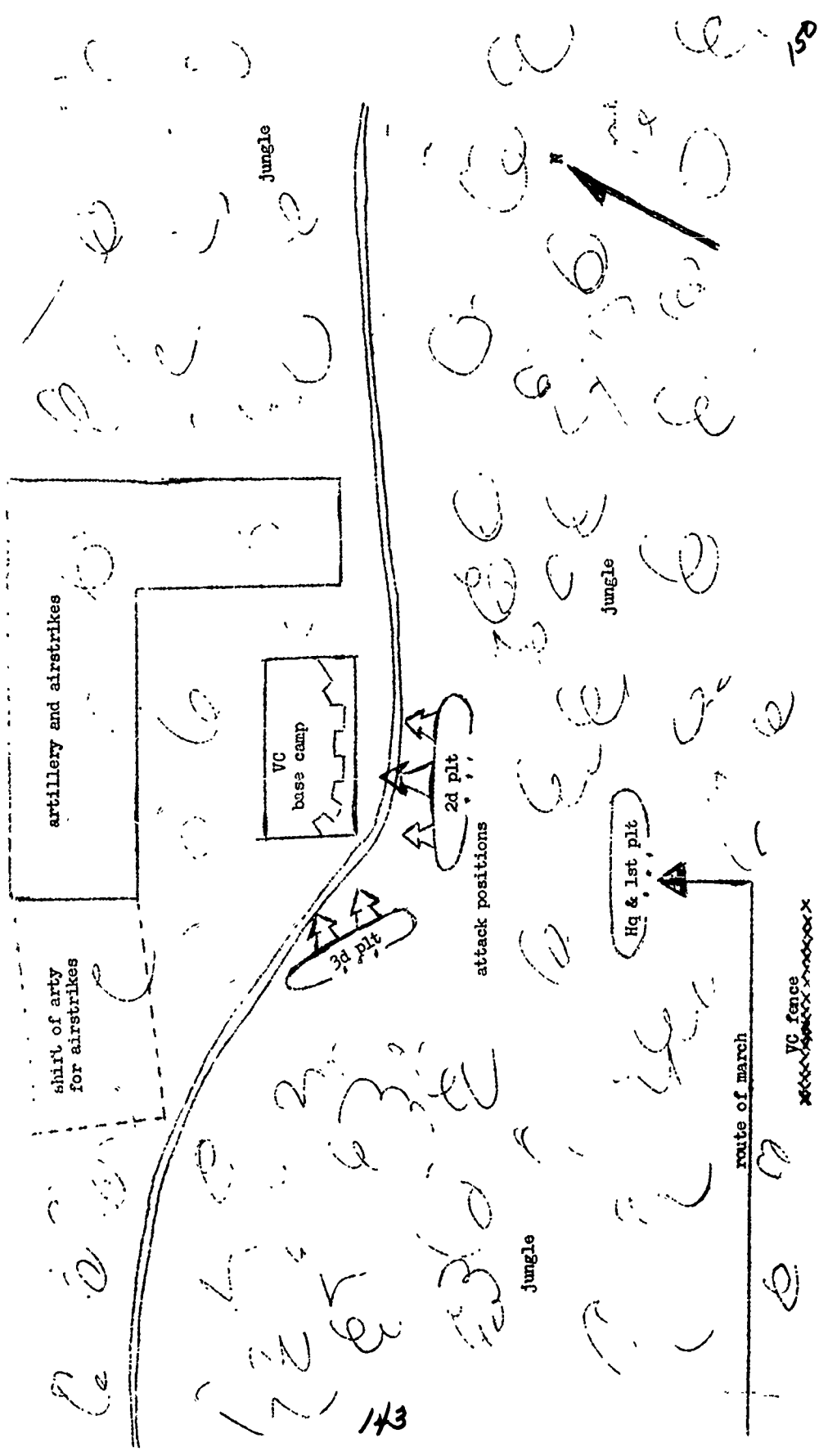

151

CONFIDENTIAL

DEPARTMENT OF THE ARMY
HEADQUARTERS 1ST INFANTRY DIVISION
17TH MILITARY HISTORY DETACHMENT

AVDB-T

1 August 1967

VC RAID ON QUAN LOI 11 July 1967

1. General:

A. Type of Action: A raid with the intent to destroy the heavy artillery and armored vehicles in an attempt to divert QUAN LOI's ability to support neighboring US/ARVN military installations.

B. Date Time Group: 110120 - 110625 July 1967

C. Friendly Units: Task Force DIXIE, 1-26 Infantry, Platoon of A Troop/1-4 Cavalry, Light Horse Charlie, C/6-15 Arty, A/6-27 Arty. Approximately 1,075 officers and men.

D. Estimated NVA/VC force: Local guerrilla units of approximately company strength supported by the 141 NVC Regiment. Size of force unknown.

E. Location of Battle: QUAN LOI, Vietnam

F. Casualties:

<u>Friendly</u>	<u>Enemy</u>
KHA: 7	KIA: 7
WHA: 27	PN: 0
Equipment Losses: None	Equipment Captured: 7 AK47s,
Equipment - Damaged: 1 Tank,	7 canteens, 7 ammo pouches,
2 APCs, 1 2½ T truck	7 ponchos, 7 bayonets, 10 RPG-2
Destroyed: 1 APC	boosters, 7 RPG rounds, 17 AK47
	magazines, 1,000 rds 7.62mm ammo,
	52 sachel charges, 30lbs explosives,
	2 bangalore torpedoes, 27 hand
	grenades, 1 compass, 1 pair sandals,
	3 propaganda leaflets.

2. Prior to the Battle:

A. Mission: US units were at QUAN LOI to secure the area under Task Force DIALL from the VC and to conduct military operations against VC/NVA forces in AO DIXIE.

B. What enemy information was available: None. No indications of the enemy's intent was known prior to the battle. Prior to the battle 5th ARVN reported between 102000H and 110600H the following bridges destroyed. XT872939, XT767761, XT765728, XT694751, XU725014, all unguarded. Also Highway 13 was cratered at XT765712, XT765800, XT817811, and XT816729, impassible for large wheel vehicles.

C. Type of Terrain: The terrain in the QUAN LOI area is characterized by gently rolling hills, with vegetation from sparse to thick in the rain forest jungle that surrounds the large "Terre a Rouges" Rubber Plantations. QUAN LOI itself is located in the center of the rubber plantations.

DOWNGRADED AT 3 YEAR INTERVALS
DECLASSIFIED AFTER 12 YEARS
DOD DIR 5200.10

144

CONFIDENTIAL

CONFIDENTIAL

152

D. Weather Conditions: Humidity 64 - 100%, thunderstorms, ceiling 500 feet, $\frac{1}{2}$ mile visibility, temperature 74° - 91°. Weather hampered aerial surveillance during the action. The guard on the tower who was on mortar/rocket watch was unable to pinpoint the location of the enemy mortars because of poor visibility.

3. The Battle Narrative: At 0105 hours the first indication of enemy activity occurred when the Quad .50 Platoon sergeant called DIXIE TOC and thought that he detected movement in front of his area towards the southwest. He asked for permission to fire. LTC Hughes, 057160, Commander of Task Force DIXIE North, was awakened and briefed by his staff on the request to fire. He had his TOC call the 1-26 Infantry to check and see if any of their patrols or ambushes were in that area. The 1-26 Infantry TOC checked their companies and then gave DIXIE TOC a negative report. LTC Hughes then gave the Quad .50s permission to open fire. This coordination took approximately 10 minutes to accomplish.

At 0120, shortly after the permission to fire was given to the Quad .50s, the VC commenced his attack by placing 60mm, 82mm, and 4.2" mortar fire on the QUAN LOI base area complex. In the same general area that the Quad .50 machine gun was firing automatic weapons fire and small fire were heard by LTC Hughes. All of the firing occurred in close sequence. At 0121 a FAC, flareship, and a helicopter Light Fire Team request were submitted immediately to the 3d Brigade at LAI KEE "to be on station as soon as possible".

By 0145 there was a lull in the mortar attack and units began receiving small arms fire. Just prior to the lull a mortar round exploded in a tree over the tent of a helicopter crew which had remained overnight at QUAN LOI. Both the aircraft commander and co-pilot were wounded as was one of their crew members. The co-pilot, Warrant Officer Thomas Hirsch, W3156223, a newly arrived officer in-country, despite his wounded arm volunteered to fly the seriously wounded aircraft commander and four other casualties out of QUAN LOI. He took off at a time when mortar, automatic weapons, and small arms fires were being received. It was night with poor flying conditions when Hirsch took off and flew to the 93d Evacuation Hospital under instrument flying conditions.

At 0147 hours A/1-26 Infantry reported seeing, one Viet Cong attempting to get out of the perimeter. The reconnaissance platoon, 1-26 Infantry was moved into positions around the DIXIE NORTH and DOBOL tactical operations centers (TOC).

"Spooky", the armed flareship, reported into the Forward Air Controller's (FAC) net at 0152. The FAC arrived on station about 10 minutes later and began setting up airstrikes.

At 0201 the A/6-27 Artillery reported that there were Viet Cong within the perimeter throwing grenades and satchel charges at the armored personnel carriers and gun positions. Most of the satchel charges failed to explode. The Quad .50 section reported incoming rounds from automatic weapons fire at the northeast corner of the airstrip. The point of origin of this automatic weapons fire was the roof of the French Plantations Administration Building.

At approximately 0205 hours A/1-4 (DRAGOON) Cavalry's positions were attacked from the front and from the rear simultaneously. Dragoon Alfa's # 26 command tank and an MFC were hit in the rear by an RPG round; the APC was destroyed as it burst into flames. A/6-27 Artillery (Haymaker) reported that there were more VC inside of the perimeter throwing hand grenades and satchel charges into the artillery gun positions. The penetration of the VC probe was deep into the artillery lines as the FDC where an unexploded satchel charge was found in the morning. In order to restore the perimeter's lines the 1-26 Infantry's reconnaissance

145

CONFIDENTIAL

CONFIDENTIAL

153
platoon was dispatched to the Haymaker/Dragoon area. During this period of time for about 30 minutes after the Dragoon command track was hit radio communication was lost with DIXIE north. By going on to the Dragoon Platoon's radio net communication was finally obtained with the senior NCO who assumed the job of platoon leader.

In addition to the attack at QUAN LOI the US advisor with the 2-9th ARVN at TAM HUNG reported to DIXIE north that a large VC force was moving towards their compound. At 0215 mortars and heavy small arms and automatic weapons fires were hitting the ARVN compound on all sides. DIXIE was informed that the ARVN battalion commanders was wounded in action and that they needed the support of US and ARVN artillery and US airstrikes. At this time the attack on QUAN LOI still was heavy in its intensity. To try to render some help to the beleaguered ARVN unit one tube of "Lighthouse Charlie" 4.2" mortars began firing night illumination and four tubes of C/6-15 Artillery fired 105mm howitzers in support of the ARVN action. When the attack on QUAN LOI began to slacken off after 0300 hours and the attack on TAM HUNG increased in its intensity LTC Hughes diverted the Light Fire Team of helicopters and the armed "Spook" flareship to the TAM HUNG area. Inside the ARVN compound was one rifle company and a headquarters company. By 0240 hours 100-150 rounds of VC mortar fire had landed in the ARVN compound; ARVN artillery was reported to be firing at the enemy forces. At 0420 hours the artillery fire was lifted as a light fire team hit the VC positions. At 0500H TAM HUNG received a 30 minute ground attack which was beaten off by the stubborn ARVN defences. Again at 0550H TAM HUNG came under a renewed attack. It was estimated at the time that 2 battalions of VC or NVA were attacking them. By 0610H the VC/NVA force broke contact with the ARVN and withdrew to the northeast.

While QUAN LOI and TAM HUNG were under attack the AN LOC Special Forces camp reported that it was under a mortar attack; however negative mortar rounds landed inside the compound. It should be noted that AN LOC is a provincial capitol, QUAN LOI is a major US military forward base support area for operation in War Zones D/C and along Highway 13, and TAM HUNG was the base of the 2-9 ARVN Infantry which were successfully pursuing an aggressive Revolutionary Development Program in the AN LOC/QUAN LOI/LOC NINH area.

The battle at QUAN LOI continued. At 0250H an ambush patrol on the ridgeline to the northwest from B/1-26 Infantry reported that there were VC between them and the perimeter. These VC were setting up a mortar to their front at XT810910. By 0315 hours the Reconnaissance Platoon 1-26 Infantry reached the French Club swimming pool area. Several reports had been made of VC infiltrators moving out from the club at the start of the attack throwing grenades and satchel charges. VC also fired their weapons from the French club at the A/1-4 Cavalry element in the vicinity of the club. One M13's crew received 100% casualties by a VC grenade exploding at the rear entrance of their track. One could also see the bullet holes in a C ration box on top of the track and a tank in the area. These bullet holes indicated enemy small arms and automatic weapons from the rear. In other words enemy fire was being placed or directed on the US troops from inside the perimeter as well as from the outside.

At 0336H the ambush patrol from B/1-26 Infantry reported that the VC were displacing their mortar tubes forward of their location at coordinates XT813912. Then at 0350H the VC again launched an attack in the vicinity of the swimming pool (XT811906). D Company 1st Engineer Bn. was instructed to send reinforcements to that area to counter the attack. At the same time C/1-26 Infantry received a heavy volume of automatic weapons fire from the French Plantation Administration Building. A squad of C/1-26 Infantry was sent to the building to check it out. At 0720H the squad reported the building to be empty of personnel but they found 8 batteries and parts from a US claymore inside of the building.

146
3

CONFIDENTIAL

CONFIDENTIAL

154

At 0415 the 1-26 Infantry Ambush Patrol that had been out on the ridge to the north was working its way back to the perimeter when 3 men were wounded by the "Spooky" mini-guns. "Spooky" was ordered to cease fire immediately. During the battle airstrikes and "Spooky" had placed their fires on the ridge to the north of the airstrip.

Again at 0430 VC mortar rounds 60mm, 82mm and 4.2" began falling into the QUAN LOI perimeter again along with small arms and automatic weapons fire. One should note that at 0345 the VC began to withdraw to the northwest past 2 empty rubber storage sheds. A break in the barbed wire was later found which the VC used in the route of withdrawal. By 0610H the VC had broken contact and the artillery continued to hammer away at VC withdrawal routes.

During the attack approximately 200 rounds of mortar fire fell on QUAN LOI. Once the base was hit with mortars the VC ground raid commenced. It is believed that the VC infiltrated at an earlier time and stayed in the French Club-swimming pool area overnight. When the mortar attack began they commenced their attack. Also the VC seen on top of the Administration Building may have infiltrated in around the same time as the group in the French Club.

4. Artillery Support:

A total of approximately 3,843 rounds of artillery were fired by US/ARVN forces in defense of the AN LOC/QUAN LOI/TAM HUNG complex that was under attack. The following is a breakdown of total expenditures:

105mm HE	2629
105mm ILL	52
4.2" HE	575
4.2" ILL	372
155mm	200
175mm	15
8"	60
GRAND TOTAL	<u>3903</u>

(includes ARVN estimates)

The following figures reflect the ammunition expenditure by US artillery at QUAN LOI:

105mm HE	1879
105mm ILL	52
4.2" HE	575
4.2" ILL	372
175mm	15
8"	60
sub total	<u>2903</u>

The following is an ARVN estimate of ARVN artillery ammunition expended:

105mm	300
155mm	200
sub total	<u>1000 (est)</u>

5. Airstrikes:

	<u>Aircraft</u>	<u>TOT</u>	<u>Ordnance</u>	<u>Location Supported</u>
A.	RR01	0300	500HD/NAP	QUAN LOI
B.	Blade 03	0320	500HD/NAP	QUAN LOI
C.	Blade 01	0435	500LD/Rockets	TAN HUNG 2-9 ARVN
D.	Box 01	0515	500HD/NAP	TAN HUNG 2-9 ARVN
E.	Buzz 01	0550	CBU/NAP	QUAN LOI
F.	Box 01	0600	CBU/NAP	QUAN LOI
G.	Blade 05 loaded with CBU/NAP arrived on station but his ordnance was not expended because the weather had closed in and was poor			

A total of 12 TAC air sorties took part in the action.

147

4

CONFIDENTIAL

CONFIDENTIAL

155

6. Helicopter gunship support:

A total of 3 helicopter fire teams supported the action as follows:

Unit	Hours	7.62mm	40mm	2.75mm
1st Aviation Bn	6.4	10,000 rds	500 rds	56 rds
11th Aviation Bn	18.7	32,000 rds	850 rds	98 rds
TOTAL	25.1	42,000 rds	1350 rds	154 rds

7. Information Received After the Action:

A. A VC captured during the attack on TAN HUNG was identified as the XO of the 4th Bn, 141 NVA Regiment. He stated that for the past few days his unit had been in the DONG XOAI area and that his unit moved to the east bank of the SONG BE River and from there marched 2 days to the AN LOC area. He reported the strength of the regiment as 1060 men with 300 men in each of the 2d, 3d 4th Bns and 160 men in the 1st (Support) Bn. He stated that the entire regiment took part in the attack and will now move back to the SONG BE River.

B. NGUYEN VAN DO a CHIEU HOI rallier to LOC NINH on 100600 July 1967. He stated that he was a squad leader of the Recon Team, 2d Platoon, 7th Company, 5th Bn 272 Regiment. He stated that on 27 June the regiment was ordered to move to BINH LONG. He stated that his battalion moved north generally parallel to the Cambodian border, then east to the vicinity of LOC NINH. He stated that he left his unit as they were moving south along Highway 13.

George E. Creighton, Jr.
GEORGE E. CREIGHTON, JR.
Captain, Infantry
Commanding

- 1 Incl
- 1. Map Sheet 6232 III-N (Series 60000)
- W. Adrawn at HQs DA

CONFIDENTIAL

148

CONFIDENTIAL

156

DEPARTMENT OF THE ARMY
HEADQUARTERS, 11TH COMBAT AVIATION BATTALION
APO San Francisco 96289

AVGC-AC

28 May 1967

SUBJECT: After Action Report of 11th Combat Aviation Battalion
Operation 10-67 (Road Clearing) 22 May 1967 (U)

TO: SEE DISTRIBUTION

1. (U) TASK ORGANIZATION

Air Mission Commander (Dobol, Devour & Dauntless) Red Dog 6
Air Mission Commander (Darkness) Dart 6
Flight 1 5 Vultures
Flight 2 10 Tomahawks
Flight 3 10 Robinhoods
Gunships: LFT ea from Crossbows, Gunslingers, and Rebels
Spares: 1 ea Vulture, Robinhood, and Tomahawk
Maintenance ship: 1 Robinhood

2. (C) MISSION:

The 11th Cbt Avn Bn lifts 2/18 Inf Bn from Dian to XT923286, 1/26 Inf Bn from XT945308 to Phuoc Hoa airfield (XT9143), 1/16 Inf Bn from XT955370 to Lai Khe, 2/28 Inf Bn from Lai Khe to XT902362, and 2 btrys of 1/5 Arty from XT9832 to FSB"U" (XT905306) and FSB"Z" (XT912429).

3. (C) SUMMARY OF OPERATIONS

a. The operations order for the mission was issued in the 11th Cbt Avn Bn conference room at 211730 May 67.

b. The 11th Cbt Avn Bn air lifted 2/18 Inf Bn from Dian to XT923286, 1/26 Inf Bn from XT945308 to Phuoc Hoa airfield, (XT9143) 1/16 Inf Bn from XT955370 to Lai Khe, 2/28 Inf Bn from Lai Khe to XT902362 and 2 btrys of 1/5 Arty from XT9832 to FSB"U" (XT905306) and FSB"Z" (XT912429). Twenty-five lift ships, 3 LFTs, 2 C&C ships and 3 support ships were committed to the mission. (36 total ships). There was no Tac air, arty or gunship prep on the LZs, as they were secured by units of the 1/11 ACR. The lifts were conducted without enemy contact. The movement of the three Inf Bns (1/28, 1/16, 2/28) under Red Dog control required one hour and forty-five minutes. One Vulture

149

CONFIDENTIAL

159

CONFIDENTIAL

AVGC-AC

28 May 1967

SUBJECT: After Action Report of 11th Combat Aviation Battalion
Operation 10-67 (Road Clearing) 22 May 1967 (U)

aircraft experienced "short shaft" failure departing the mini-port at Lai Khe. There were no injuries to the crew, and only minor damage to the aircraft. The aircraft was evacuated by CH-47 to Phuoc Vinh.

c. Flight data

- (1) Enroute altitude: 1500 ft
- (2) Enroute formation: STR
- (3) Landing formation: TRL
- (4) Size of flights: 5 ships

d. The 11th Cbt Avn Bn provided the following support:

	<u>Sorties</u>	<u>Passengers</u>	<u>Tons</u>	<u>Hours</u>
UH-1	536	1779	1.6	109.2
CH-47	138	206	276.0	27.0

4. (U) ADMINISTRATION AND LOGISTICS

a. Supply: All twenty-five lift ships, and the three LFTs utilized 16 refueling points at the miniport at Lai Khe, (south of Hocking pad) for refueling. The refueling was done in flights of five, which eliminated any congestion in mini-port area.

b. Maintenance

One aircraft experienced "short shaft" failure at Lai Khe. It was evacuated by CH-47 to PV.

c. Medical: Negative casualties were received.

5. (U) COMMENTS AND RECOMMENDATIONS

None

150

CONFIDENTIAL

CONFIDENTIAL

158

AVGC-AC

28 May 1967

SUBJECT: After Action Report of 11th Combat Aviation Battalion
Operation 10-67 (Road Clearing) 22 May 1967 (U)

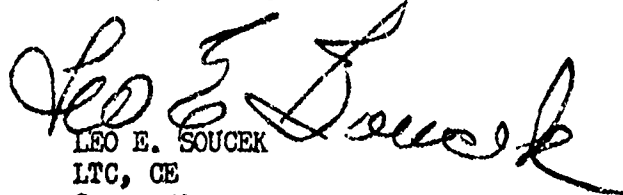
LEO E. SOUCEK
LTC, CE
Commanding

DISTRIBUTION:

- 2 CG 1st Inf Div
- 2 CG 1st Avn Bde
- 2 CO 12th Cbt Avn Gp
- 2 CO 11th Cbt Avn Bn
- 2 CO 1st Avn Bn
- 1 ea Co 11th Cbt Avn Bn
- 1 LNO 1st Inf Div
- 1 S3 file

151

CONFIDENTIAL

159

DEPARTMENT OF THE ARMY
HEADQUARTERS 1ST ENGINEER BATTALION
APO 96345

AVDB-CE-3

11 August 1967

SUBJECT: Combat Operation After Action Report

THRU: Commanding General
1st Infantry Division
ATTN: AVDB-T
APO 96345

TO: Commander
US Military Assistance Command, Vietnam
ATTN: J321

1. NAME OF OPERATION: Operation PAUL BUNYAN
2. DATE OF OPERATION: 151000 Jul 67 to 281430 Jul 67

3. GENERAL: The command headquarters for the engineer portion of Operation Paul Bunyan was Headquarters, 1st Engineer Battalion, Di An, acting in accordance with 2nd Bn (Mech), 2nd Inf OPCR 7-67 dated 16 July 67. The 1st Engineer Battalion provided combat support to 1st Infantry Division operating in the southern portion of the Ong Dong jungle.

a. Reporting Officer: THORWALD R PETERSON
Commanding Officer
1st Engineer Battalion

b. Task Organization:

Hq, 1st Engineer Battalion - LTC THORWALD R PETERSON

Company B (-) - CPT MARION L. CALDWELL JR.

4. INTELLIGENCE:

a. Intelligence prior to operation:

(1) The area of interest is the Ong Dong jungle and the surrounding villages. The Ong Dong jungle provides a covered and concealed route from War Zone D to the center of the Lam Son area of operation.

(2) Enemy Forces: Since 15 May 67 there have been numerous VC units sighted in the operational area. The units sighted were the Phu Loi Bn, Autumn Fighters, C-265 Co, C-63 Co, C-300 Plt, C-118 Plt, and Tan Hoa Khanh guerrillas. This area is used as a base camp from which they launch operations and as a supply storage area (NOTE: During clearing operations, friendly units should expect to encounter minings, mortarings, sniping incidents, ambushes, and other related activities).

b. Intelligence during operation:

The following was detected and destroyed:

17 July 67 (1) 105 mm round vic XT 919155

152

11 Aug 67

SUBJECT: Combat Operation After Action Report

5. MISSION: 1st Engineer Battalion supports 1st Infantry Division operation by opening and maintaining MSR.

6. CONCEPT OF OPERATION:

a. 1st Engineer Battalion supported 1st Infantry Division units engaged in Operation Paul Bunyan with one company (-).

b. Company B, 1st Engineer Battalion supported 2nd Brigade, 1st Infantry Division units engaged in Operation Paul Bunyan with 2 platoons.

(1) 1st and 2nd Platoons were charged with constructing a by-pass of Tan Uyen through the Ong Dong jungle.

(2) 3rd Platoon continued its base development and civic action projects.

c. Company A continued its direct support of the 1st Brigade with base development and civic action projects.

d. Company C continues its direct support of 3rd Brigade base development and civic action projects.

e. Company D, E, & Hqs, continued general support of the Division.

7. EXECUTION:

15 Jul 67:

B Company - 1st plt, 2nd plt, Hqs plt elements moved out of Di An 1000 hours 15 July 67 for NDP area (XT908164). Arrived NDP 1045 hours 15 July 67. Began constructing overhead cover at NDP. 2000 hours 15 July 67 all elements had overhead cover and sandbagged sleeping quarters. Mine sweepers swept 8 km of road. Hqs element continued to support line platoons.

16 Jul 67:

B Company - 1st plt departed NDP 0800 hours to install two 18" culverts 36' long w/headwalls at XT917204 and XT918204. Also used 25 loads of laterite for fill at culvert site. 2nd plt departed NDP 0800 hours to install two 24" culverts 36' long w/headwalls at YT924202. 20 loads of laterite were utilized for fill at culvert site. Repaired and reshaped road with (2) graders from coordinates XT928197 to XT917204. Used 10 loads of laterite for road repair. Hqs plt continued to support line platoons.

17 Jul 67:

B Company - 1st plt and 2nd plt worked jointly on road project at coordinates XT918204 to XT918213. Utilized 94 loads laterite for road construction. Both elements departed NDP 0800 hours and returned 1700 hours. All individuals worked from 1800 hours until approximately 2100 hours on improving bunkers and sleeping quarters at NDP area. Mine sweep teams found dud 105 mm round at XT919155. It was blown in place. Hqs plt continued to support line platoons.

18 Jul 67:

B Company - 1st plt and 2nd plt worked jointly on road construction using 125 loads of laterite and four loads of rock. Both elements departed NDP approximately 0820 hours for work site at YT918204. Hqs plt was in direct support of line platoons.

153

11 Aug 67

SUBJECT: Combat Operation After Action Report

19 Jul 67:

B Company - 1st plt and 2nd plt departed NDP 0800 hours for job site. 86 loads laterite and 20 loads of rock were utilized for road construction from XT918204 to XT918213. Work was greatly hampered by lack of dry base material. Hqs plt continued in support of line platoons.

20 Jul 67:

B Company - 1st plt and 2nd plt continued to work on road construction. Each element departed NDP 0820 hours. Received support from three 5 ton dumps from D Company and three 5 ton dumps from Fqs Company to help haul rock and laterite. 170 loads of laterite and 25 loads rock were hauled to work site at XT918213 to XT918215. Hqs plt continued in support of line platoons.

21 Jul 67:

B Company - 1st plt continued to work on road construction by hauling 195 loads laterite and stockpiled 56 loads of rock at laterite pit. Traffic directed elements were furnished by 1st plt. 1st plt was assisted by three 5 ton dumps from D Company and three 5 ton dumps from Hqs Company that were attached to B Company. 2nd plt worked at spreading laterite, shaping and grading the road bed from XT918204 to XT918215. Hqs plt continued in support of line platoons.

22 Jul 67:

B Company - 1st plt continued to work laterite pit hauling 28 loads laterite and 64 loads of rock to job site. Also continued in traffic direction enroute to work site. Provided shotguns for Fqs vehicles. 2nd plt continued construction of road by spreading rock and laterite, grading, shaping, cutting ditches and compacting road from XT918204 to XT918215. Hqs plt continued in support of line platoons.

23 Jul 67:

B Company - All elements stood down, 0800 - 1200 hours for maintenance. 1st plt continued direction of hauling materials to job site. 2nd plt graded, reshaped and spread rock. 1st plt hauled 20 loads of rock to their work site. 2nd plt did work on road coordinates XT918204 to XT918215. Hqs plt continued in support of line platoons.

24 Jul 67:

B Company - 1st plt supervised transportation of materials to work site. 32 loads of rock were hauled to job site. Also used four EM for hand ditching on road job site. 2nd plt worked to reshape and backblade road with dozer in order to try and reduce moisture content of road bed. Hqs plt continued in support of line platoons.

25 Jul 67:

B Company - 1st plt, 2nd plt and 12 EM from 3rd plt combined efforts to construct 50 meters of corduroy road. (Cord. XT918215 to XT918216). 2nd plt had three dozers working on drainage ditches for removing enough water and mud to enable the construction of this corduroy road. 1st plt directed stock piling of 28 loads of rock at laterite pit. Hqs plt continued in support of line platoons.

154

11 Aug 67

162

26 Jul 67:

B Company - 1st plt and 2nd plt continued to direct the diverting of mud and water to enable further construction of road bed XT918204 to XT918215. 1st plt and 2nd plt combined efforts to construct 125 meters of corduroy road XT918216 to XT918217. 1st plt stock-piled 19 loads of rock at laterite pit and hauled five loads of laterite to work site. 1500 rubber trees vic XT9121 were cleared as a experiment using 180 feet of cruiser chain pulled by two D7E's. Hqs plt continued to support line platoons,

27 Jul 67:

B Company - 1st plt hauled seven loads rock for repair of Rte 313, spread rock, reshaped and graded road from Rte Bronze to XT916196. 2nd plt used 15 loads rock to construct approaches to corduroy road at XT918215. Hqs plt continued in support of line platoons.

28 Jul 67:

B Company - 1st plt, Hqs plt, and 2nd plt proceeded to destroy NDP and move to Di An. Elements departed NDP area 1300 hours arrived Di An 1430 hours. 1st plt and 2nd plt had 30 men retrieving materials from corduroy road XT918216 to XT918217. Hqs plt returned to Di An 1430 hours and prepared to construct base camp support operations.

8. RESULTS:

a. Friendly losses:

- (1) Personnel: None
- (2) Equipment: None

b. Enemy losses:

- (1) Personnel: None
- (2) Equipment: None

c. Construction:

- (1) A complete rehabilitation of Rte Bronze Tan Uyen bypass from XT928198 to XT918217 was accomplished.
- (2) Defensive positions were constructed at NDP.
- (3) 755 loads of laterite and 219 loads of rock were hauled to upgrade Rte Bronze Tan Uyen bypass.

9. ADMINISTRATIVE:

- a. Average strength in field during operation - 75.
- b. Supply: Normal channels with daily runs to Di An.
- c. Maintenance: All equipment repair was performed at base camp or at field locations.

155

11 Aug 67

SUBJECT: Combat Operation After Action Report

- d. Transportation: Organic transportation used for road work.
- e. Communications: TC&E FM radios were the principle means of communications.
- f. Medical: The unit had organic aid men.

10. SPECIAL EQUIPMENT AND TECHNIQUES:

An experiment was conducted on the techniques of clearing rubber trees with an anchor chain. The 180 foot chain, being pulled with two D7E dozers, proved to be quite effective as a rubber tree clearing method. Approximately 1500 trees were cleared within a period of four hours.

11. COMMANDER'S ANALYSIS:

The operation proved to be a successful engineer training vehicle and gave experience in field operations to newly assigned personnel. However, the operation presented numerous problems to road construction. The major limiting factor was the weather. With increased rain activity the soil became too muddy to operate in effectively. Sufficient compaction could not be obtained due to this high moisture content. As a final solution a corduroy road was constructed of 3x12 material in order to resupply the infantry. It is concluded that during the monsoon season adequate road construction cannot be feasibly carried out due to the compaction necessary and lack of sufficient base materials available in this country.

FOR THE COMMANDER:

DISTRIBUTION:
Special

Stanley G. Genega
STANLEY G GENEGA
1LT, CE
Adjutant

156

CONFIDENTIAL

163

COMBAT OPERATIONS AFTER ACTION
REPORT

"BLUEFIELD"

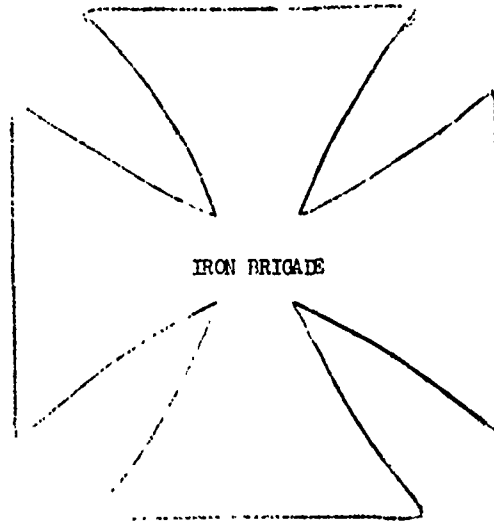

SIDNEY M. MARKS
Colonel, Infantry
Commanding

CONFIDENTIAL

157

167

CONFIDENTIAL

DEPARTMENT OF THE ARMY
HEADQUARTERS 3D BRIGADE AND LAI KHE BASE
1st Infantry Division
APO 96345

AVEE-WB-C

27 June 1967

SUBJECT: Combat After Action Report (MACV/RCS/J3/32)

THRU: Commanding General
1st Infantry Division
APO US Forces 96345

TO: Commander
US Military Assistance Command, Vietnam
ATTN: J321
APO US Forces 96243

1. NAME AND TYPE OF OPERATION: Operation BLUEFIELD; Search and Destroy.
2. DATES OF OPERATION: 051100 June 1967 to 091500 June 1967.
3. GENERAL: Command Headquarters 3d Brigade, 1st Infantry Division. 1st Infantry Division OPLAN 14-67 (BLUEFIELD I); 3d Brigade, 1st Infantry Division OPORD 12-67, dated 031200 June 1967. Operation BLUEFIELD was conducted in the area North-east of Lai Khe. The 3d Brigade plan was to conduct a multi-battalion combat assault on 05 June 1967 and conduct combat reconnaissance in assigned AO; and to destroy VC/NVA forces and installations within the operational area.
 - a. Reporting Officer: Colonel Sidney M. Marks
 - b. Task Organization:
Headquarters, 3d Brigade, Colonel Sidney M. Marks, CO
2-28 Infantry, LTC Jerry S. Edwards, CO
1-16 Infantry, LTC Rufus C. Lazzell, CO
2-2 Infantry (Mech) LTC John D. Fendalton, CO
1-4 Cavalry, LTC John W. Siegle, CO
2-33 Artillery, LTC Charles D. Daniel, CO
4. INTELLIGENCE:
 - a. Intelligence Prior to the Operation: The operational area extended approximately 12 Km North and 13 Km East, Northeast of Lai Khe bounded by coordinates XT7440, XT7454 and East to the Song Be River. Major communication arteries within the area are Highway 13 on the West and the Song Be River on the East. The other significant transportation artery is secondary road 302 which branches off Route 13 vicinity XT795542 and leads Southeast. The last major operation in this area was Operation TUJSON which kept Route 13 open, and was conducted to the West. There had been no serious probes in this area East of Highway 13, however agent reports and other intelligence reports indicated tax collection points along Highway 13 in this general area and movement of the 273d VC Regiment and small groups (company and squad size) entering and departing this area daily. SIAR and SPAR activity also confirmed movement and campsites of unknown size in the area. The last major contact in this area was on 20 March 1967 when friendly elements were attacked by 2d Battalion 273d VC Regiment in which they suffered heavy casualties, (vicinity XT7845). Political elements considered to be in this area and can be committed are THU DAU MOT, LONG BINH PROVINCE, BEN CAT DISTRICT and CHON THANH DISTRICT COMMITTEES and their subordinate elements.
 - b. The actual area of operation as indicated in paragraph "a" above, had many base camps, some recently constructed and some which were old and not recently used. Many base camps had overhead cover on the bunkers and connecting tunnel systems. Some structures (incl tunnels) had reinforced steel and concrete supports

158

CONFIDENTIAL

CONFIDENTIAL

and evidence indicated some groups had recently departed the base camps prior to the arrival of friendly troops. This was evidenced by hot food and hot ashes. Friendly elements did not engage any VC units but did receive sporadic sniper fire, indicating the VC chose not to defend their installations, but rather to deploy individual snipers and conduct harassing activities. A very large number of booby traps ranging from homemade handgrenades to 155 MM rounds were found throughout the entire area, indicating the VC may have used this area as a rear echelon ammunition and weapons repair center. A total of 24 weapons were captured in the base camps, some weapons which were homemade, and others which appeared in the stages of being repaired, along with powder, primers, cartridge cases (full and empty), gunsmith tools. Medicine and rice caches were small and of no significant value. The size and type structures discovered indicate this area to be a possible "secure" area used by the VC for re-training and refitting of elements of the 273d Regiment, and possibly other elements of the 9th VC Division.

c. Terrain in the operational area is generally flat and broad leaf ever-green forest, intermingled with brush wood and bamboo forests in the Northeast corner. The area along Route 13 has been defoliated in many places, however the double type canopy still hides most of the ground throughout the remainder of the area. Weather was characterized by occasional rain and did not impede the operation.

d. Base camps, fortifications, tunnels etc, were in most cases well constructed, with overhead cover, good camouflage and strategically located. Most significant discoveries are as follows:

- 12 Bunkers w/OH cover VIC XT872458
- 100 Foxholes VIC XT836482
- 5 Huts & 300 Meters of Trench VIC XT863475
- 25 - 30 Bunkers VIC XT893481
- 20 Bunkers VIC XT865477
- 300 Meter tunnel leading off in several directions and large enough to walk in VIC XT871468
- 15 Huts VIC XT870449

e. The area is sparsely populated with the exception of a few villages along Highway 302.

5. MISSION: 3d Brigade conducts air assault into LZ's 16 and 18 and conducts Search and Destroy Operations in sector to kill VC/NVA personnel and to destroy VC/NVA installations.

6. CONCEPT OF OPERATION:

a. Maneuver: The 3d Brigade conducts a multi-battalion air assault and ground assault on 05 June 1967 with, 2-28 Infantry, 1-16 Infantry landing on two LZ's; conducts combat reconnaissance in assigned AO to destroy VC/NVA forces and installations within the operational area.

b. Fire Support: Artillery fire support will be as follows:

- (1) 2-33 Artillery: DS to 3d Brigade
 - (2) 6-15 Artillery: Reinforce 2-33 Artillery
 - (3) 1-5 Artillery: GSR 2-33 Artillery
 - (4) A-8-6 Artillery: Reinforce 2-33 Artillery
 - (5) B, C-8-6 Artillery: GSR 2-33 Artillery
 - (6) C-6-26 Artillery (8"/175): GS
- Artillery to be located as follows:
- (1) FSB 33: 2-33 Artillery (-), A-8-6 Artillery
 - (2) LAI KHE: 6-15 Artillery and A-2-33 Artillery
 - (3) PHUOC VINH: 1-5 Artillery, B C-8-6 Artillery, C-6-27 Artillery.

7. EXECUTION:

05 June 1967 - The 3d Brigade began Operation BLUEFIELD by conducting an air assault with two infantry battalions on two LZ's and a ground assault with the 1-4 Cavalry. At 0800 hours, the 1-4 Cavalry commenced movement toward objective F, vicinity XT880450. After an extensive air and artillery preparation, the 1-16 Infantry conducted an air assault into LZ 16, vicinity XT875483 commencing at 1100 hours, and

169

CONFIDENTIAL

closing at 1135 hours. The 2-28 Infantry conducted an air assault into LZ 28 vicinity XT828477, commencing at 1300 hours and closing at 1330 hours. Both LZ's were undefended. The 2-2 Infantry secured FSB 33 vicinity XT781451 and swept and secured Highway 13 from Lai Khe to XT783495 by 1020 hours. During the days operation, the 2-2 Infantry located and destroyed a 15 lb road mine at XT784462 and a 30 lb Chicom shape charge at XT784482. At 1145 hours, vicinity XT870449, C Troop, 1-4 Cavalry located and destroyed a base camp containing two homemade shotguns, small arms ammo, 1-55 gallon drum containing explosives, 13 huts and 3 bunkers. Documents found in the area were evacuated. At 1347 hours, vicinity XT867458, A Troop, 1-4 Cavalry located a partially destroyed base camp with a boobytrapped entrance. A sign at the entrance read "Beware Danger Friend". A rifle, handgrenade and some documents found in the base camp were evacuated. At 1512 hours, vicinity XT863471, A Company, 1-16 Infantry located a base camp containing 3 huts, 15' by 30' with bunkers, weapons parts, documents, blackboards and clothing. The documents were evacuated. A VC hiding in a well in the base camp was killed during the search of the area. At 2040 hours, A Company, 1-16 Infantry received one incoming rifle grenade vicinity XT877483 resulting in one WIA. Mortars and M79 rounds were fired in return with unknown results. The 2-28 Infantry established an NDP vicinity XT852472, the 1-16 Infantry at XT875483 and the 1-4 Cavalry at XT855443. The remainder of 05 June 1967 passed without incident.

06 June 1967 - The 3d Brigade continued Operation BLUEFIELD. The 1-16 Infantry conducted two company size Search and Destroy operations in AO B and B vicinity XT845490 and XT855470 respectively. The 2-28 Infantry conducted Search and Destroy operations in AO A, vicinity XT820460. The 1-4 Cavalry conducted Search and Destroy operations in AO B, vicinity XT855460. At 0618 hours, vicinity XT837463, A Company 2-28 Infantry located a company size base camp containing clothing, small amount of rice, hair clippers and 4 CBU's. All items were destroyed. While sweeping Highway 13, 2-2 Infantry located and removed 3 road blocks, two at XT792423 and the third vicinity XT782406. B Company 2-2 Infantry swept and secured Highway 13 from FSB 33 to Lai Khe, completing at 1031 hours. While sweeping the road, two 20 pound shape charges, vicinity XT792426, two electrical pressure type devices with wires, vicinity XT791450, and an anti-personnel mine vicinity XT793422 were located and destroyed. At 0958 hours, vicinity XT877446, C Troop 1-4 Cavalry located and destroyed a base camp containing 3 bunkers, 3 sleeping positions, 3 flywheels, 1 bicycle, 5 foxholes and 1/2 ton scrap iron. Documents located were evacuated. At 1105 hours, vicinity XT814465, A Company 2-28 Infantry, located and destroyed a hut containing 400 lbs of unpolished rice. At 1120 hours, vicinity XT871468, A Troop, 1-4 Cavalry located a large tunnel complex. There were negative findings in the tunnel and it was destroyed. At 1129 hours, vicinity XT865477, C Company 1-16 Infantry located and destroyed an old base camp with 20 bunkers. At 1210 hours, vicinity XT860490, Company B, 1-16 Infantry located and destroyed 8 ox carts. At 1510 hours, vicinity XT867476, C Company, 1-16 Infantry located and destroyed a company size base camp. Documents, medical supplies, and one homemade single shot weapon were found in the area and evacuated. At 1744 hours, vicinity XT794437, B Company 2-2 Infantry located and destroyed an anti-tank mine. At 2025 hours, vicinity XT855443, the 1-4 Cavalry NDP received 4 to 5 incoming mortar rounds. Counter mortar fire was returned with unknown results. There were negative US casualties or damage. All battalions defended the same NDP's and the remainder of the 6th of June 1967 passed without incident.

07 June 1967 - The 3d brigade continued Operation BLUEFIELD. The 1-16 Infantry conducted Search and Destroy Operations in the Eastern part of AO B, vicinity XT895490. The 2-28 Infantry conducted Search and Destroy operations in the Eastern part of AO A, vicinity XT875445. At 0343 hours, vicinity XT855443, the 1-4 Cavalry NDP received 6 incoming mortar rounds, but suffered no casualties or damage. At 0752 hours, vicinity XT792425, B Company 2-2 Infantry located and destroyed a Chicom 30 lb anti-tank mine and four anti-personnel mines. At 0810 hours, vicinity XT880491, the Recon Platoon, 1-16 Infantry located and destroyed 11 rounds of 57 MM recoilless rifle ammunition and 5 US handgrenades. At 0846 hours, vicinity XT792432, A Company 2-2 Infantry located and destroyed one Chicom 20 lb claymore with 20 lbs of TNT rigged for command detonation. A Company, 2-28 Infantry located and destroyed several small base camps throughout the day in the vicinity of XT836482. Three 60 MM mortar rounds and three Chicom grenades found in the area were evacuated. At 0900 hours, vicinity XT889451, C Troop, 1-4 Cavalry located and destroyed 20 bunkers. The 2-2 Infantry had Highway 13 cleared and secured from FSB 33 to Lai Khe by 0912 hours. At 0930 hours, vicinity XT885461, C Company, 1-16 Infantry found and evacuated a 230 volt generator. At 0930 hours, vicinity XT867476, A Company, 1-16 Infantry located and destroyed a company size base camp containing a kitchen and CP bunker. A total of 25 beer can type handgrenades, 1-8" round, 1-105 round and assorted small arms ammunition were located and destroyed. A 45 caliber pistol, rifle (type unknown)

CONFIDENTIAL

160

11

CONFIDENTIAL

and parts for a 38 caliber pistol were located and evacuated. At 1050 hours, vicinity XT885491, C Company, 1-16 Infantry located and destroyed 4 unserviceable shotguns. At 1318 hours, vicinity XT827507, Company B, 2-28 Infantry located and destroyed one homemade shotgun, two bangalore torpedoes, 15 rounds of 50 caliber and 40 rounds of 20 MM ammunition. Seventy-five pounds of loose unmilled rice was also destroyed. At 1329 hours, vicinity XT887439, A Troop, 1-4 Cavalry located and destroyed one hut, one bunker, one bicycle frame, cooler pot, bamboo traps, 1-155 MM and 1-60 MM mortar round. At 1345 hours, vicinity XT857471, A Company, 1-16 Infantry located a small base camp containing 8 ruck sacks, one Chicom claymore, one box of 30 caliber ammunition, one Chicom grenade, five bunkers and 400 meters of trenchline. One of the ruck sacks contained propaganda material and was evacuated. At 1508 hours, vicinity XT882481, C Company, 1-16 Infantry located and destroyed two homemade mines along with some web gear. At 1516 hours, vicinity XT836484, A Company 2-28 Infantry located and evacuated 1 lb of documents. At 1552 hours, vicinity XT876431, A Troop, 1-4 Cavalry fired on one VC with a cannister round with unknown results. At 1630 hours, vicinity XT872424, A Troop, 1-4 Cavalry located a small base camp containing 5 bunkers, a garden, one 105 MM round, chopsticks and some recent newspapers. At 1732 hours, vicinity XT864474, A Company, 1-16 Infantry located and destroyed two handgrenades and two RPG rounds. At 1935 hours, vicinity XT834475, an ambush patrol from A Company, 2-28 Infantry made contact with an unknown size VC force resulting in one US MIA. Small arms, mortars and artillery were fired into the area with unknown results. All battalions defended the same NDP's. The remainder of 7 June 1967 passed without incident.

08 June 1967 - The 3d Brigade continued Operation BLUEFIELD. The 2-2 Infantry continued to secure FSB 33 and cleared and secured Highway 13 from FSB 33 to Lai Khe by 0830 hours. The 2-28 Infantry conducted Search and Destroy operations in A0's B and D, vicinity XT845490 and XT855470 respectively. The 1-4 Cavalry continued Search and Destroy operation in A0 F, vicinity XT875445. The 1-16 Infantry, after extensive artillery preparation, conducted a two company air assault into LZ vicinity XT872510, commencing at 0910 hours and closing at 0947 hours. At 0835 hours, vicinity XT845472, B Company, 2-28 Infantry located and destroyed two boobytrapped Chicom handgrenades. At 0810 hours, vicinity XT868435, A Troop, 1-4 Cavalry located and destroyed two huts, two bunkers, a boobytrapped box and two 20 lb bags of polished rice. At 0900 hours, vicinity XT846483, A Company, 2-28 Infantry located and destroyed 10 foxholes and 3 huts. At 0938 hours, vicinity XT869423, A Troop, 1-4 Cavalry located and destroyed 2 bunkers, 1-81 MM dud, 1-105 MM dud, 1 mine detector and 1 bicycle. At 1043 hours, vicinity XT843464, B Company 2-28 Infantry located and destroyed a base camp containing 5 huts, 25 bunkers, 500 lbs of polished rice and 2 VC grenades. At 1333 hours, vicinity XT877455, C Troop 1-4 Cavalry located a large base camp containing 25 bunkers and 75 meters of trenchline. At 1343 hours, vicinity XT846467, B Company 2-28 Infantry located and destroyed two cooking huts, 1000 lbs of polished rice, 100 lbs of salt and 2000 lbs of unpolished rice. At 1427 hours, vicinity XT829470, C Company, 2-28 Infantry located and destroyed 5 boobytrapped handgrenades and 100 handgrenades. At 1454 hours, vicinity XT835477 A Company 2-28 Infantry located and destroyed 800-50 lb bags of peanuts. At 1459 hours, vicinity XT847459, B Company, 2-28 Infantry located and evacuated a can of documents and one Chicom bolt action rifle with bayonet. At 1505 hours, vicinity XT854438, A Troop, 1-4 Cavalry received one WIA and one KIA from a boobytrapped 60MM mortar round. At 1525 hours, vicinity XT877455, C Troop, 1-4 Cavalry located and evacuated a diary. At 1539 hours, vicinity XT855465, B Company, 2-28 Infantry located and evacuated a FRC 10 set on frequency 46.50. At 1546 hours, vicinity XT872452, C Troop 1-4 Cavalry located a base camp containing 12 bunkers, 3-105 rounds, 6 CBU's, 3-155 rounds, 2-81 MM rounds, 1-60 MM round, 3 mauser rifles, 1 rusted shotgun and one German semi-automatic carbine. At 1850 hours, vicinity XT881482, C Company 1-16 Infantry located a civilian type Willys Jeep license number G81500. At 2318 hours, C Troop 1-4 Cavalry spotted one individual about 30 meters from the perimeter of the NDP. M79 rounds were fired with unknown results. At 1654 hours, both companies of 1-16 Infantry completed their airlift back to the battalion NDP. All battalions defended the same NDP's. The remainder of the 8th of June passed without incident.

09 June 1967 - The 3d Brigade concluded Operation BLUEFIELD by extracting all units from their field locations. The 1-4 Cavalry departed their NDP at 0730 hours, and moved by road to PHU LOI. The main body closed at 1335 hours and the trail party closed at 2020 hours. The Squadron became OPCON of the 1st Division upon closing. At 1215 hours, vicinity XT848363, an SP 40 MM gun from A 5-2 Artillery hit a road mine resulting in minor damage to the vehicle. At 0833 hours, vicinity XT789410, A Company, 2-28 Infantry located and destroyed 3 anti-personnel mines rigged for command detonation. At 0853 hours, vicinity XT793424, an APC from A Company, 2-28 Infantry hit a 105 MM dud rigged as a road mine, resulting in minor damage to the

161

CONFIDENTIAL

171

CONFIDENTIAL

vehicle. An additional 105 MM round was destroyed. At 0917 hours, vicinity XT789410, A Company, 2-2 Infantry located and destroyed one anti-tank mine and one shape charge rigged for command detonation. The 1-16 Infantry was extracted from LZ 16 commencing at 0950 hours and closed LAI KHE at 1102 hours. The 2-28 Infantry was airlifted from LZ 28 commencing at 1320 hours and closing LAI KHE at 1411 hours. At 1434 hours, the 2-2 Infantry, 2-33 Artillery (*) and A Battery 8-6 Artillery departed FSB 33 and closed LAI KHE at 1554 hours.

6. SUPPORTING FORCES:

a. Artillery: The operation was supported by 2-33 Artillery; 6-15 Artillery, reinforcing; 1-5 Artillery, OSR; C-6*26 Artillery, OS. Artillery fires were planned on all LZ's during the operation. Artillery fires were used extensively in support of ground forces. A total of 6676 rounds of 105 MM and 3513 rounds of 155 MM were expended.

b. Air Force: The Air Force provided aerial observation and reconnaissance throughout the operation. Air Force ordnance was used in preparation of LZ's and in support of ground forces. A total of 73 close air support sorties were flown in conjunction with the operation.

9. RESULTS:

a. Personnel Losses:

- (1) US Losses: 1 KIA 2 WHA
- (2) VC Losses: 1 KIA (UC)

b. Equipment Losses:

- (1) US Losses: None
- (2) VC Losses:

(a) Weapons:	Captured	Destroyed
Homemade Shotguns	2	-
Homemade Rifles	2	-
45 Caliber Pistol	1	-
38 Caliber Pistol	1	-
Shotguns	11	-
7.62 Chicom Rifle	1	-
German Mauser Rifles	3	-
British Bullfield Rifles	2	-
(b) Ammunition:		
Chicom Hand Grenades	2	139
50 Caliber Ammo Rounds	14	50
7.62 Rounds	145	-
7.92 Rounds	122	35
CBU	1	19
AT Mines	-	2
30 lb Shape Charges	-	3
20 lb Shape Charges	-	2
30 Caliber Rounds	-	282
8 inch rounds	-	1
105 MM Rounds	-	6
Beer Can Grenades	-	25
60 MM Rounds	3	6
Handheld Flares	-	2
55 Gallon Drum Explosives	-	1
55 Gallon Drum CS	-	1
US Handgrenade	-	6
Mine Detonators	-	3
AP Mines	-	9
155 MM Rounds	-	4
57 MM Rounds	-	11
TNT (Pounds)	-	25
Chicom Claymores	-	3
Blasting Caps	-	100
RPG Rounds	-	2

CONFIDENTIAL

162

CONFIDENTIAL

Bangalores	-	2
20 MM Rounds	-	40
Bomb Fuse	-	1
81 MM Mortar Rounds	-	3
100 lb Bomb	-	1
500 lb Bomb Casings	-	2
Carbine Magazines	-	4
MMR Magazines	-	4

172

(c) Food Stuffs:

Unpolished Rice (pounds)	-	5015
Salad oil (gallons)	-	2
C-Rations (cans)	-	6
Salt (pounds)	-	100
Peanuts (tons)	-	20

(d) Documents found throughout the operation were evacuated through S-2 channels.

(e) Miscellaneous:

US Protective Mask	1	-
Miners Lamp	1	-
VC Flags	2	-
Tools Miscellaneous	-	-
Electric Generator	1	-
Ruck Sack	1	-
Willys Jeep	1	-
2 1/2 Ton International Truck	1	-
Blackboards	-	2
6 Volt Batteries	-	2
Combat Boots (pair)	-	2
Hair Clippers	-	1
Helmet Liner	-	1
Canteen	-	1
Poncho Liners	-	2
Guitar	-	1
Steel Reinforcing Rods (ton)	-	1/2
Flywheels	-	3
Ox Carts	-	8
Lantern	-	1
Cups & Saucers	-	61
Galvanized Drum	-	1
Sleeping Bags	-	4
Rice Bowls	-	5

Miscellaneous tractor parts were evacuated, and a small amount of clothing was destroyed.

10. ADMINISTRATIVE MATTERS:

- a. Supply: Resupply was conducted by air and road. No supply problems were encountered.
- b. Maintenance: No maintenance problems were encountered during the operation.
- c. Treatment of Casualties, Evacuation and hospitalization: No unusual problems were encountered with medical evacuation or treatment of the wounded.
- d. Transportation: No major transportation problems were encountered during the operation.
- e. Communications: Throughout the operation no problems were encountered with communications between the Brigade CP and the various battalions.

11. SPECIAL EQUIPMENT AND TECHNIQUES: No special equipment or techniques were employed during this operation.

12. COMMANDERS ANALYSIS: Operation BLUEFIELD was initiated to close with the

163

CONFIDENTIAL

123

CONFIDENTIAL

273d VC Regiment which had been reported in the area of the operation. However, the VC had moved out of the area prior to the beginning of the operation leaving behind care-taker forces in the base camps.

Although little damage was done to the VC, all units gained much needed experience in the preparation for and conduct of an airmobile assault, resupply operations, and jungle combat operations.



SIDNEY M. MARKS
Colonel, Infantry
Commanding

CONFIDENTIAL

164

173-

DEPARTMENT OF THE ARMY
HEADQUARTERS 1ST INFANTRY DIVISION
APO San Francisco 96345

AVDB-CG

SUBJECT: Fundamentals of Infantry Tactics

TO: Brigade, Battalion, and Company Commanders

1. Swift and enduring lessons in tactics are taught by the Viet Cong, but combat experience is a hard and costly school. I am concerned that as our leaders rotate, our battle-won wisdom shrinks. However, I am convinced that if we help successor leaders to grasp a few tactical principles and basic techniques, victory--and comparatively inexpensive victory--will invariably crown our future undertakings. Therefore, I have asked a group of seasoned officers to draw up the enclosed compendium based on their combat experiences. I direct each of you to study it carefully, and to use it as your guideline for operations and training.

2. I will expect to find in your command, at the minimum, evidence of your attention to and emphasis upon:

- a. Exploiting artillery and air firepower for all missions.
- b. Maintaining security and dispersion under all circumstances.
- c. Moving to contact with particular care to find the enemy with scouts.
- d. Controlling advanced elements tightly, so that at any time precise position of units is known, and immediate use of air and artillery is possible.
- e. Searching the battlefield with system and thoroughness.
- f. Digging defensive positions which are well fortified to the front and overhead, with weapons sited painstakingly for maximum surprise and flanking fire upon an assaulting enemy.

3. The hallmarks of 1st Division leaders, our distinctive professional traits, have been (1) violent, massive firepower; (2) firm control of maneuver at all times; (3) security under all conditions; (4) cloverleaf patrolling; and (5) deep foxholes with full frontal berm overhead cover, and 45

164

176

AVDB-CG

SUBJECT: Fundamentals of Infantry Tactics

degree firing ports. That future leaders of the Big Red One are similarly endowed is my most serious responsibility, and yours.

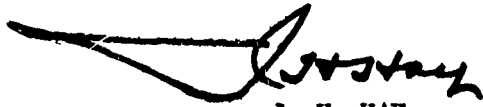

- 4 Incl
- 1. The Enemy
- 2. Big Red One
Battle Principles
- 3. Defense
- 4. Offense

J. H. HAY
MG, USA
Commanding

177

THE ENEMY

1. INTELLIGENCE IS FOR ALL COMMANDERS: The tactical area of interest (TAOI) of the 1st Division encompasses BINH DUONG Province--the seedbed of armed communism in Vietnam--eastern War Zone C, western War Zone D, and the infiltration routes through BINH LONG and PHUOC LONG Provinces. Table I identifies the principal Viet Cong formations operating within the TAOI, both main force and local force. 1st Division leaders should take advantage of every available opportunity to learn about these units, and their strengths and weaknesses. In this war, intelligence cannot be relegated to staff specialists; it governs our tactics no less than our plans and operations.

2. MAIN FORCE UNITS: a. Since 1962 the Viet Cong have relied strategically on main force units of regiment and division size, composed of full time soldiers. The 9th Light Infantry Division, among the oldest and most successful of the VC main force organizations, operated during 1965 north of SAIGON down to the metropolitan suburbs. Since 1965 operations of the 1st Division have driven the 9th Division northward, away from the centers of population, into the jungles of War Zones C and D. A series of tactical defeats by the 1st Division have seriously depleted the regiments of the 9th Division, and its original South Vietnamese soldiers have been replaced by North Vietnamese to a significant degree, especially among the cadre and leaders.

b. Main force units normally operate in elements no smaller than battalion, and are well equipped with a full range of modern infantry

165

weapons, including heavy machine guns, mortars, and recoilless rifles. Within the War Zones, 120mm mortars have been encountered, and artillery and artillery rockets also must be expected. Unit communication equipment-- largely wire, with some radios--is adequate. Some weaknesses may lie in the morale, motivation, and state of training of the VC soldiers within main force units stemming from tensions between Northerners and Southerners, continued deprivation of the pleasures of civilization, lack of familiarity with the terrain, disease, and in some instances starvation. These occasionally detract from unit efficiency, but not dependably so.

3. LOCAL FORCE UNITS: The Viet Cong continue to wage intensive war with full time guerrillas (organized usually into district companies or provincial battalions), part-time guerrillas (usually district companies), and village militia (clandestine activists). Local force units are often, but not always, poorly equipped in most respects, but the local force guerrilla can be a better trained, more resolute foe than his main force counterpart. The style of the main force is regimental attack or ambush; that of the local force a two-man claymore attack or a road mining. The strength of the local force is the guerrilla's ability, through long familiarity with his own neighborhood, to merge with the populace or fade quickly into a base camp once he strikes.

4. BASE CAMPS: a. For both main force and local force units, base camps are essential for survival. Deeply rooted in Communist doctrine is the importance of a "secure base area" for guerrilla operations. The local force units tend to place their reliance on numerous small camps dispersed throughout their areas of operations. In BINH DUONG Province virtually every

178

179

patch of woods conceals at least one small circular entrenchment with associated bunkers and tunnels, and each local force unit has at least one elaborately fortified refuge; larger units have a tunnel complex in which their hospital and headquarters are located. Some of these tunnels are more than 20 years old, and many are hundreds of meters in length. Local force base camps are usually extensively booby trapped, and often protected by punji pits. Main force base camps are usually not so well guarded by mines; they are, of course, larger, and frequently include training facilities, such as rifle ranges and classrooms. Having constructed numerous, well fortified, pre-stocked base camps throughout his area of operations, the enemy may shift his forces as the situation dictates, either for offensive or for defensive reasons.

b. Any defended Viet Cong base camp presents a formidable problem to attackers. One local force squad has been known to withstand assault by two US infantry companies, and even a VC sniper or two, firing from within a mined camp, can inflict numerous casualties on a maneuvering force. Coliteration of local base camps and surrounding jungles using bulldozers has unquestionably been effective. However, our attempts to demolish base camps, using explosives, have been comparatively unsuccessful. Evidence suggests that the enemy soon re-enters and restores partially damaged base camps unless constant patrolling, or other US counter-action prevents him.

5. COMMUNICATION-LIAISON ROUTES: The military organization of the enemy is patterned after the cellular organization of the Communist party. General dissemination of combat intelligence, and even information on Viet Cong dispositions is rare; leaders are discouraged from inquiring into

168

180.

situations beyond their own unit and area of operation. Accordingly, fixed communication-liaison routes assume great importance to the Viet Cong units moving from one zone to another, since they must usually follow an established chain of base camps using a series of guides to pass from one area to the other. Supply parties and messengers follow the same routes; frequent "cut-outs" and transfer points are prescribed. US interdiction of such routes invariably causes confusion and dismay.

6. VC ATTACKS: Viet Cong offensive operations are usually launched from a base camp, and participating troops are well rehearsed in withdrawal routes, primary and alternate, from the point of attack to the same or another base camp. It is important to appreciate that all enemy military doctrine is couched in offensive terminology. Viet Cong "counter sweep" operations--the posture the Viet Cong assume to defend against large search and destroy operations--are described in their orders and other documents in terms of attacks by small groups upon the advancing enemy. In practice, this means the enemy units dispatch small elements to conduct harassing counter-attacks with mortars, rifle grenades, claymores, and other mines as the situation permits. This tactic is intended to maintain close contact with our forces, thus reducing vulnerability to our fires. Counter sweeps also visualize the gradual intensification of harassing actions up to and including all out attacks upon our forces once they appear fatigued or depleted, and their strengths and vulnerabilities have been accurately appraised. The terminology "attack" embraces any means of producing casualties among allied forces, including setting pressure mines in the road. Mortar attacks on US bases, both artillery field positions and our permanent

181

bases, is a preferred Viet Cong mode of offensive action. A meeting engagement outside fortifications with Viet Cong forces larger than platoon is rare, but there have been at least three instances in the past year of a Viet Cong force engaging, by what appeared to be an impromptu ambush, a US rifle company patrolling in the jungle. The Viet Cong prefer better odds and more carefully reconnoitered and planned operations. One favored form is the regimental ambush of a vehicular column on a road--a tactic to which the 9th Light Infantry Division resorted three times in the course of two months in the summer of 1966. Another preference is a regimental assault upon a US defensive position. Post-battle analysis suggests that the enemy plans his maneuver basically on terrain information, that is, knowing we were occupying a position in a given clearing, he maneuvered into position to attack the clearing. However, usually his attack was preceded by ground reconnaissance and probes designed to single out locations of our automatic weapons, and identify weak points in our defense. Invariably, his attacks were preceded by intense mortaring and numerous volleys from direct fire weapons. His assault, when it was launched, was delivered over a wide front, but he concentrated a large mass of his infantry in considerable depth upon one small sector of our position in an effort to penetrate at that point. A number of these large scale attacks were launched in the early morning hours, as though the attackers expected to capitalize upon the first daylight during the latter stages of their assault, when they had penetrated our position. The assault itself was intense and aggressively pressed, with heavy reliance being placed on hand grenades as well as the submachine gun. All these attacks were markedly unsuccessful; enemy initiated ground attacks were the greatest single source of enemy losses over the past year.

182

TABLE I PRINCIPAL VIET CONG FORCES 1ST INFANTRY DIVISION TAOI

<u>MAIN FORCES</u>	<u>AREA OF OPERATIONS</u>	<u>REMARKS</u>
9th VC Division 271st VC Regiment 272d VC Regiment 273d VC Regiment	War Zones C&D	A highly mobile light infantry division which normally conducts regimental size operations. Oldest VC division in the III Corps Tactical Zone, this division has been the 1st Infantry Division's primary opponent.
7th NVA Division 52d NVA Regiment 141st NVA Regiment 165th NVA Regiment	PHUOC LONG and BINH LONG Province War Zone C	Elements of this division entered the Corps Tactical Zone in 1965. It is believed the division was formed during 1966. Ridden with disease, this unit is only just beginning to be a combat effective unit.
101st NVA Regiment	War Zone C&D	Independent mobile regiment formerly under the operational control of the 9th VC Division.
<u>LOCAL FORCES</u>		
PHU LOI Battalion	BINH DUONG Province	A well trained, high morale provincial battalion. The 1st Infantry Division has had frequent contacts with this battalion. It is the principal local force battalion in the division area.
C61 Company C62 Company C63 Company C64 Company C70 Company C81 Company	South BEN CAT District CHANH THANH District LAI THIEU District DAU TIENG District BINH LONG North BEN CAT District	Viet Cong district companies which vary in strength from 50 to 120 men. These companies are armed with mixed weapons. Their combat effectiveness varies from the highly proficient with high morale to those which are combat ineffective in other than platoon level operations. These companies operate within their districts and reinforce the hamlet and village guerrillas.
<u>POLITICAL HEADQUARTERS</u>		
COSVN	Located in War Zone C	Political and military headquarters directing all military and political elements of the Viet Cong effort in the majority of South Vietnam.

171

183

TABLE I (continued)

<u>POLITICAL HEADQUARTERS</u>	<u>AREA OF OPERATIONS</u>	<u>REMARKS</u>
Military Region I	Located in War Zone D	Subordinate to COSVN. Controls and directs VC activity in all of the III Corps area except SAIGON, BINH LONG, BINH TUY, and PHUOC LONG areas.
Military Region IV	Located in Southeastern BINH DUONG	Controls VC activity, political and military, in SAIGON and its surrounding district.
Military Region 10	Probably located in PHUOC LONG	New region in two northernmost provinces of III Corps area--BINH LONG and PHUOC LONG training and recuperation base for infiltrating units.

172

184

BIG RED ONE BATTLE PRINCIPLES

1. Infantry, armor, and Army aviation find the enemy.
2. Air and artillery kill the enemy.
3. Battalion commanders must know unit locations within 10 meters at all times.
4. Keep plans and schemes of maneuver simple.
5. Put your back to a landing zone.
6. Foxholes are deep, properly sited, camouflaged, have full overhead cover and a frontal protective berm.

173

185

DEFENSE

1. TEAMWORK: The 1st Division has earned well a reputation for building sound defenses, and fighting from them magnificently. But reputation will never defeat an attacking Viet Cong force. Perhaps more than any other type of operation, successful defense hinges on sound planning, hard preparatory work, vigorous execution, and aggressive follow-up at every level:

*The rifleman whose shovel, muscle, weapon, and courage are the foundation of the defense.

*The NCO whose know-how shapes and ties together the position, who leads the defenders at the point of decision.

*The company officer who lays out the position, and controls the infantry weapons.

*The battalion commander who selects key weapon positions, arranges artillery concentrations, and pre-planned air, and commands the fight on the ground.

*The brigade commander who supervises preparation, and manages from the air fires and exploiting maneuver.

2. THE US COUNTER TO ENEMY ATTACK: The Viet Cong are a tough and wily foe from whom surprises are to be expected. Nonetheless, their doctrine and training seems to compel them to follow a pattern. Usually their attacks are preceded by reconnaissance and light probes designed to delineate our positions, locate our key weapons, and identify weak spots in our line. They then bring their mortars and recoilless rifle well forward, and lay them directly on specific US weapons whose positions they fix during the reconnaissance. Their attack itself is heralded by intense fires from these heavy weapons,

174

TABLE I

VC ATTACK & US COUNTER

186

<u>ENEMY TACTIC</u>	<u>1ST DIVISION DEFENSE</u>
(1) *Reconnaissance: probes, harassment, pre-attack targeting	(1) *Counter-recon security screen: LP & OP's trip flares and claymores *Camouflaged positions *Fire discipline
(2) *Indirect fire: mortars, recoilless rifles, rifle grenades	(2) *Overhead cover
(3) *Direct fire: recoilless rifles, RPG, MG, claymores	(3) *Camouflaged positions *Low silhouettes *Full frontal berms
(4) *Frontal assault: SMG and grenades; concentrated infantry	(4) *Wire and other obstacles *Trip flares *Claymores *Full frontal berms *Flanking, grazing fire *Positions in depth *Large caliber direct fire

175

187

followed by a frontal assault of the US line. The assault infantry are normally led by submachine gunners firing continuously from the hip as they run, supplemented by grenadiers. 1st Division defenses are designed to frustrate both enemy heavy weapons, and enemy infantry assault. Table I outlines the means by which we counter specific enemy tactics.

3. FIGHTING POSITIONS: The Big Red One fighting position adheres to the following principles:

- a. A frontal protective berm to deflect direct fire.
- b. Forty-five degree firing ports.
- c. Full overhead cover.
- d. Camouflaged to blend into the background.
- e. Low silhouette.
- f. Permits "Bee Hive" rounds to be fired without endangering occupants.
- g. Is continually improved so long as position is occupied.

4. SITE SELECTION: Difficulty with an individual position--inability to perform mission or extensive labor--usually starts with poor choice of site. Leaders must look for the ground with best command of long graze in their sector, and emplace their automatic weapons there. They should also look for natural cover and concealment for positions, and use it well. Each machine gun should be protected by at least two rifle positions. Positions should be sited in depth, that is, displaced from front to rear 10-50 meters from one another, as in the following idealized diagrams (Figures 1 and 2). It is not sufficient for a company commander, platoon leader, or squad leader to simply locate his unit upon the general trace of a perimeter and begin to

176

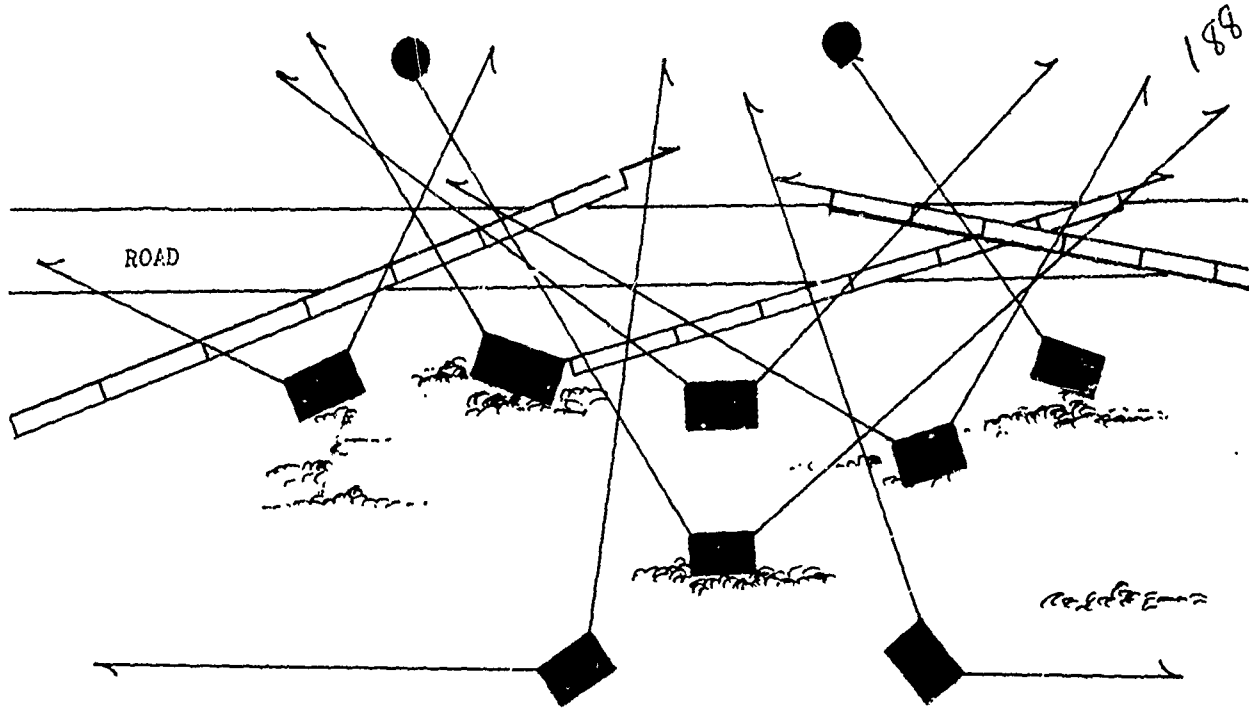
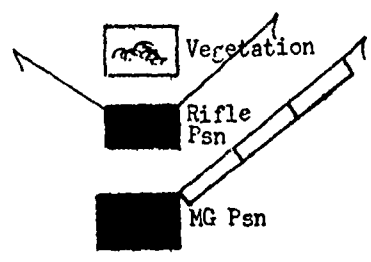
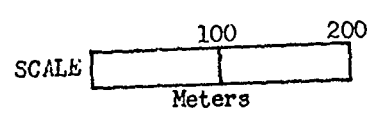
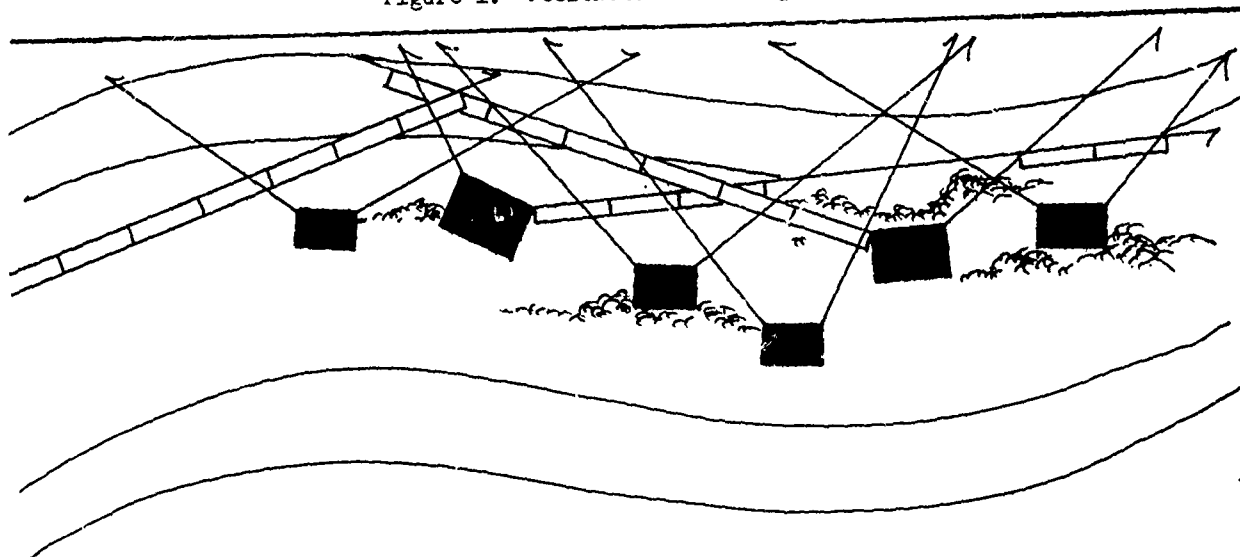

Figure 1. Positions on level ground



177
Figure 2. Positions on uneven ground
14

189

dig. These leaders must develop a sensitivity for the defensive possibility of any piece of ground their unit occupies. They must visualize how the defense of their assigned sector will develop. They must be alert to the slightest changes in the lie of the terrain; by moving the tentative location of a position as little as five feet, a fine field of fire may develop, or there may be provided a site offering classic cover and concealment. Leaders must develop the facility to visualize the role each position will play in the defense, and how the whole sector will interlock into a coordinated system of mutually supporting positions. They must walk the terrain, identify avenues of approach, and calculate how to defeat enemy assault on those approaches. In selecting his position the commander will, if possible, avoid pushing the defensive perimeter out to the tree line at the edge of a clearing. Well dug-in positions in the open, covered by listening posts in the forest, take advantage of available fields of fire, and are also less vulnerable to attack by mortars since tree bursts cannot impact directly upon the unit. The commander will site his fighting positions to form a perimeter in depth, avoiding a lineal or regular circle configuration, and to interlock positions for maximum mutual support by flanking and covering fires among individual positions. He will take steps to insure that each soldier will know his own field of fire and that of supporting positions, and that each of the subordinate leaders will know the same information for all the positions under his command, plus the planned mortar and artillery fires (to include planned "bee-hive" fires) which can support his area of responsibility. Normally, he will establish a unit SOP for the defense and follow it, but any SOP must provide for siting or checking key positions by the defense commander, and his designating

178

which shall be two, three, or four man positions.

190

5. SEQUENCE OF WORK: a. Select site. Primary concern is fields of fire, but look also for natural cover and concealment for each position. Walk key machine gun final protective lines to check the selected position, and to identify dead space.

b. Plan camouflage. Calculate how position will be blended into background, and establish paths for approaching site, for pitching tents, and for passing forward to clear fire lanes.

c. Dig a foxhole throwing up spoil to form a berm, which is progressively packed, formed; and apertured.

d. Clear (or preferable selectively thin out) fields of fire, to provide fire lane down each FPL, and observation over the whole assigned sector.

e. Complete walking FPL's and prepare range cards.

f. Emplace claymores; a minimum of one per man.

g. Emplace wire. A frontal perimeter barrier line of trip flares, plus concertina (if available), and obstacles along the friendly side of each FPL.

h. Continue to improve foxhole. Stock hole with ammo, providing storage niches.

i. Put overhead cover on foxholes.

j. Complete camouflage of front.

k. Dig entrance trench, and supplementary hole(s), and camouflage them.

l. Camouflage tents and paths.

m. Dig communications trenches and reserve positions and camouflage.

Camouflage will be replaced as needed, berm improved as appropriate, covered

191

fireteam will use overwatch within the fireteam (half moving and half overwatching). The forward movement is by bounds. This type of movement again allows the minimum number of men to become engaged by the same source of firepower at once, and someone to return fire immediately. When this squad has moved 100 to 200 meters, depending on terrain, the squad leader will set up a defense position and send his fireteams, one at a time, to the flanks in a cloverleaf. The fireteam (cloverleafing) will advance using the overwatch within the fireteam (half moving and half in a position overwatching). The other fireteam will always be overwatching. When this action is completed, he will call the platoon leader who will displace the platoon forward, followed by the company until contact is made with the point. As soon as contact is made with the point, it will move out again repeating the same steps. The company will, upon closing on the point squad, set out security immediately and then send patrols out to the flanks. (Each rifle platoon will send a patrol to both flanks.) The patrols will go out, depending on terrain, no less than 40 meters. The rear platoon will, in addition to cloverleafing, send security to the rear. The platoon directly behind the company Hq group should send security to secure the command group. When all cloverleaf patrols have returned, the company commander must be notified so that he can move the company forward upon the call from the point element. This type of movement is slow and requires practice, good control and lots of patience; however, time and again, units using the cloverleaf have scouted out the enemy, destroyed him by fire, and then maneuvered in upon his positions without serious casualties. The cloverleaf method is slow. The company depicted (Figure 1) will cover only about 2000 meters in eight hours of advancing. Some

180

192

commanders who have elected to advance otherwise have taken heavy casualties in their lead platoon and suffered more attempting to extricate them. It is difficult to outline the application of the clover-leaf principle which would correspond to every situation. The preceding example is merely illustrative. Occasions will arise when greater speed of movement will be dictated by mission, terrain, or enemy situation. The clover-leaf principle holds that the rifle company will advance preceded by patrols in all directions. Successful employment of the clover-leaf principle requires intense practice: sand tables or chalk drills at platoon and company level, and practical exercises on terrain, as often as possible. Success also requires patience of commanders at battalion level and above, for they must accept the inherently slower pace of advance which adherence to the clover-leaf principle demands.

181

193

4. ACTIONS UPON CONTACT. Enemy contact in the jungle usually occurs at point blank range, and more often than not the enemy will enjoy advantages of fortifications, snipers in trees, communication trenches, and minefields to his front and flanks. It is imperative that upon contact, at all echelons, teamwork begins as follows:

a. Company in contact. High volume of fire in direction of enemy, not neglecting trees. Immediately mark most advanced elements and flanks with smoke. Report direction (magnetic azimuth) to enemy, and range from one marking. Initiate artillery fire mission. Withdraw to place at least 50 meters between most forward element and enemy. Straighten line parallel to enemy line, or to desired air strike runs. Report estimated enemy strength, equipment, and direction withdrawal (if any).

b. Battalion commander. Immediately request FAC, air strikes, and artillery observer. Locate precisely by map grid point of contact and mark for FAC. Initiate artillery blocking fires, if company FO has not done so. Alert reserves, medical evacuation aviation, and emergency resupply. Control air strikes if company commander not in position to do so.

c. Commanders at all echelons. Aggressive instincts to flank the enemy position must be curbed. Once the enemy position is established, all commanders must strain their resources to bring available fires to bear on the enemy. Each commander from company on up must be capable of employing air and artillery, practiced in utilizing the channels of communications for each, and quick to initiate action to bring each into play. The most crucial information which the unit in contact must supply is the direction in which the enemy is withdrawing. Based on this sensing, commanders at

182

194

higher echelons deliver fires to block the avenue of enemy withdrawal or reinforcement. Fires are shifted outward from the point of contact progressively, and are discontinued only when, in the judgment of the battalion or brigade commander, the enemy has escaped. The inception of a heavy volume of artillery fire, and sustained fire can be facilitated by (1) "walking" fires in advance of and to the flanks of the unit as it moves to contact, and (2) keeping the artillery shooting despite use of air in the target area. Upon contact, time should not be wasted on prolonged attempts to fix precise targets. It is imperative that the supporting fires be initiated immediately. They can be initiated at a greater distance and subsequently is worked toward the unit as the situation clarifies. Battalion and brigade commanders must continually keep informed of the location of friendly fire support bases, and periodically war game the simultaneous employment of air and artillery in the event of contact. As a rule, artillery should never be cut off to facilitate delivery of air; rather, it should be shifted to augment the air in a blocking role. Constantly adjusted air-artillery fire control lines can be employed. Experience confirms that once artillery is cut off in favor of air, excessive time is lost in resuming fire. Experience also underscores the importance of the battalion commander choosing correctly among the relative advantages of air and artillery in each given situation. In general, air is the preferred instrument in dense jungle, or against base camps, because it can be delivered dependably very close to troops. Napalm is a fine close support weapon, but should always be delivered parallel to the friendly front. CBU is deadly against enemy outside fortifications, and should also be delivered parallel. Bombs are the answer to VC emplacements. Light artillery

183

196

is generally ineffective against fortifications, but is a fine, high volume antipersonnel weapon capable of achieving local fire superiority if nothing else. Light artillery and mortars can, of course, be fired in close support, but these too perform more reliably fired parallel to friendly front. Medium and heavy artillery must be echeloned in depth from friendly troops, but can effectively destroy VC fortifications. The mastery of fire control and fire coordination is the most important challenge faced by battalion and brigade commanders in Vietnam. Delegation of fire coordination is impossible; only the commander or the S-3 has the feel for the situation required.

5. FOLLOW-UP TO FIREPOWER: When in the judgment of the commanders concerned fires on the enemy have been effective, the advance will be resumed. Security to front and flanks is restored, and the unit enters the enemy position. At this time the mission of the infantry is thorough police of the battlefield. The Viet Cong are adroit at concealing personnel, arms, documents, and other valuables, and care and imagination are necessary for the searchers to ferret out the fruits of victory. Prisoners are especially valuable in this conflict, and pains should be taken to capture, safeguard, and treat medically any VC who survive our bombardment. Any documents, no matter how unimportant appearing they may be, should be evacuated. It should be a matter of pride to any infantry unit that an area it has searched is left devoid of intelligence.

6. ROAD CLEARING OPERATIONS: Offensive operations frequently entail securing a road for use as an MSR. In undertaking to clear a road, infantry commanders should commence operations by passing troops in V formation down the road, with the opening of the V in the direction of advance. The ends

184

of the wings echeloned forward and outward from the road should be at least 100 meters away from the ditchline, and the soldiers therein should be carefully instructed to search for wires and other signs of command detonated mines or claymores. At the point of the V, on the road itself, about 200

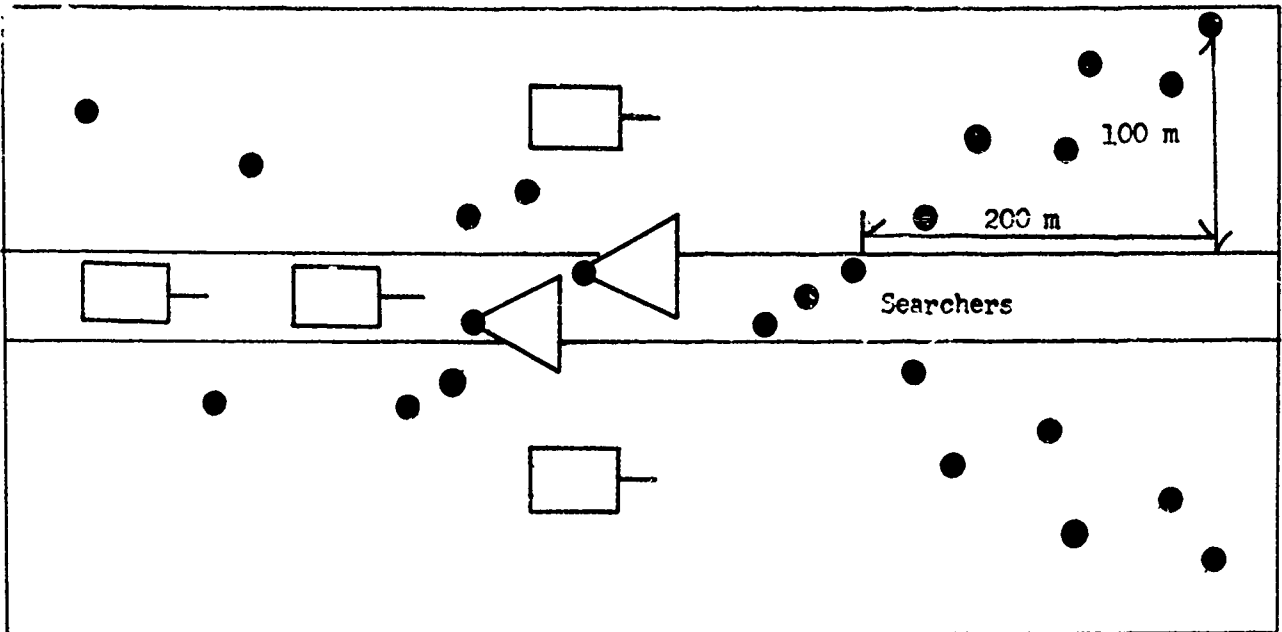

Figure 2. Inverted V for road clearing meters rearward, should be mine sweep teams.

Experience establishes that the best mine detector we possess is an alert infantryman with a keen eye, noticing tracks, disturbances in the surface of the road, or wires. Once the initial clearing patrol moves down the road, the road must be secured against re-mining and snipers. Troops or armor assigned the securing mission must penetrate into the vegetation alongside the road to beyond the limits of visibility, and must patrol actively. Above all, troops engaged in road clearing must remain alert and dispersed at all times; in any other posture, they court multiple casualties from claymores or other command detonated mines.

199
7. TRAINING: a. No unit should move outside a secured, permanent base camp except in tactical formation. Leaders at every level must regard every move as training, and none must hesitate to stop a maneuver if it is being done wrong.

b. Musketry for infantry units should be practiced on every opportunity. As a minimum, riflemen should be required to fire through a basic load at maximum rate to teach them the meaning of volume fire, and to give them a feel for their firepower. Use of tracer ammunition, snap shooting at surprise targets, night firing, and cross training on the machine gun and grenade launcher is also helpful, and cannot be repeated often enough. Fire team and squads must be permitted to conduct field firing as a team.

c. After action critiques are superb training, and help significantly in developing sound SOP.

186

UNCLASSIFIED

Security Classification

DOCUMENT CONTROL DATA - R & D

(Security classification of title, body of abstract and indexing annotation must be entered when the overall report is classified)

1. ORIGINATING ACTIVITY (Corporate author) OACSFOR, DA, Washington, D. C. 20310		2a. REPORT SECURITY CLASSIFICATION Confidential	
		2b. GROUP 4	
3. REPORT TITLE Operational Report - Lessons Learned, Headquarters, 1st Infantry Division			
4. DESCRIPTIVE NOTES (Type of report and inclusive dates) Experiences of unit engaged in counterinsurgency operations, 1 May - 31 July 1967			
5. AUTHOR(S) (First name, middle initial, last name) CG, 1st Infantry Division			
6. REPORT DATE 25 August 1967		7a. TOTAL NO. OF PAGES 187	7b. NO. OF REFS
8a. CONTRACT OR GRANT NO.		9a. ORIGINATOR'S REPORT NUMBER(S) 670742	
b. PROJECT NO.		9b. OTHER REPORT NO(S) (Any other numbers that may be assigned this report)	
c. N/A			
d.			
10. DISTRIBUTION STATEMENT			
11. SUPPLEMENTARY NOTES N/A		12. SPONSORING MILITARY ACTIVITY OACSFOR, DA, Washington, D. C. 20310	
13. ABSTRACT			

DD FORM 1473
1 NOV 65

UN

END-3-68